

Twist-Lock® Devices
 20A, 250V AC; 2 Pole, 3 Wire Grounding
 Insulgrip® Connector

HUBBELL

Features

- All black ribbed nylon housing provides a secure grip and impact and chemical resistance.
- Superior cord grip design protects terminations from excess strain.
- Clear, funnel shaped wire entry for ease of termination.
- Integral dust shield protects wiring chamber from dust or contaminants.



Ordering Information

Description	Cord Diameter	UPC	Catalog Number
Black nylon.	.360"-.930"(9-24)	783585172231	HBL2323BK

Listings

Listed to UL 498
 Fed.Spec. W-C-596
 Certified to CSA C22.2 No.42

Specifications

Housing / Cord Clamp	Nylon
Terminal Retainer	Clear polycarbonate
Contacts	Brass
Terminal Screws	#10-32 Brass (Phillips / Slotted / Robertson)
Terminal Clamp	Cold rolled steel – nickel plated
Assembly Screws	Steel - nickel plated

Performance

Electrical	
Current Interrupting	Certified for current interrupting at full rated current
Dielectric Voltage	Withstands 2,000V minimum
Mechanical	
Terminal Accommodation	#16 AWG - #8 AWG stranded copper wire only.
Terminal Identification	Terminals identified in accordance with UL 498
Environmental	
Flammability	HB or better per UL94 or CSA 22.2 No. 0.6
Moisture Resistance	IP20 Suitability
Operating Temperatures	Maximum Continuous 75°C Minimum -40°C (w/o impact)

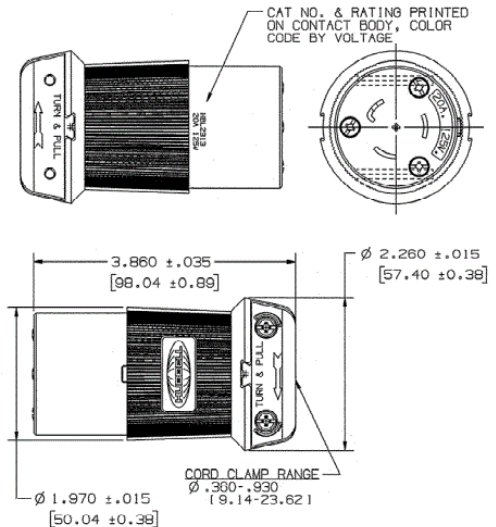

Accessories

Plug	HBL2321BK
Weatherproof Boot	HBL6032

Resources

Customer Use Drawing
 eCatalog



Distributor:
 Phone: 407-857-8770
 Fax: 407-857-8771
 Email: sales@techni-lux.com
 www.techni-lux.com

Dimensions in Inches (mm)

Hubbell Wiring Device-Kellems • Hubbell Incorporated (Delaware) • 40 Waterview Drive • Shelton, CT 06484

Phone (800) 288-6000 • Fax (800) 255-1031 • Specifications subject to change without notice.

