

SEETRONIC

Product Data Sheet

Product Type IP65 XLR Plug

Product Model CO-XLR5FBGIP-S (SCWF5-B)

Customer Name _____

Manufacturer	Prepared	Checked	Approved

Customer	Received	Checked	Confirmed

Distributor:
 Phone: 407-857-8770
Fax: 407-857-8771
Email: sales@techni-lux.com
www.techni-lux.com



Product Data Sheet

Product Type	IP65 XLR Plug	
Product Model	SCWF5-B	

Product Features

- 5-core waterproof XLR female cable connector with black plated housing and gold plated contacts
- Waterproof rating IP65
- The metal housing uses internal thread design to ensure that it can withstand gravity under any site conditions
- Cable O.D.: 5-8mm
- No ring design, more compact
- The boot is equipped with a polyurethane sealing sleeve to prevent the cable from being affected by bending pressure to the greatest extent



Product Data Sheet

Product Parameters

Item	Specification
Connection Type	XLR
Gender	Female

Electrical Parameters

Item	Specification
Capacitance between contacts	≤ 7 pF
Contact resistance	≤ 3 m Ω
Dielectric strength	1.5 kV DC
Insulation resistance	> 10 G Ω (initial)
Rated current per contact	7.5 A
Rated voltage	< 50 V



Product Data Sheet

Mechanical Parameters

Item	Specification
Cable O.D.	5~8 mm
Insertion force	≤ 20 N
Withdrawal force	≤ 20 N
Service life	> 1000 mating cycles
Cable size	Max.1.0 mm ² Max.18 AWG
Locking device	Latch lock



Product Data Sheet

Material and Environmental Parameters

Item	Specification
Boot	PA
Contacts	Cu alloy
Contact plating	Au
Insert	PA
Housing	Zinc alloy
Housing plating	Black plating
Strain relief	POM
Flame-retardant grade	UL 94 HB
Protection class	IP65
Temperature range	-30°C ~ +80°C

Standards and Certifications

Standards	IEC 61076-2-103
Solderability	Complies with IEC 68-2-20



Product Data Sheet

Product Drawing

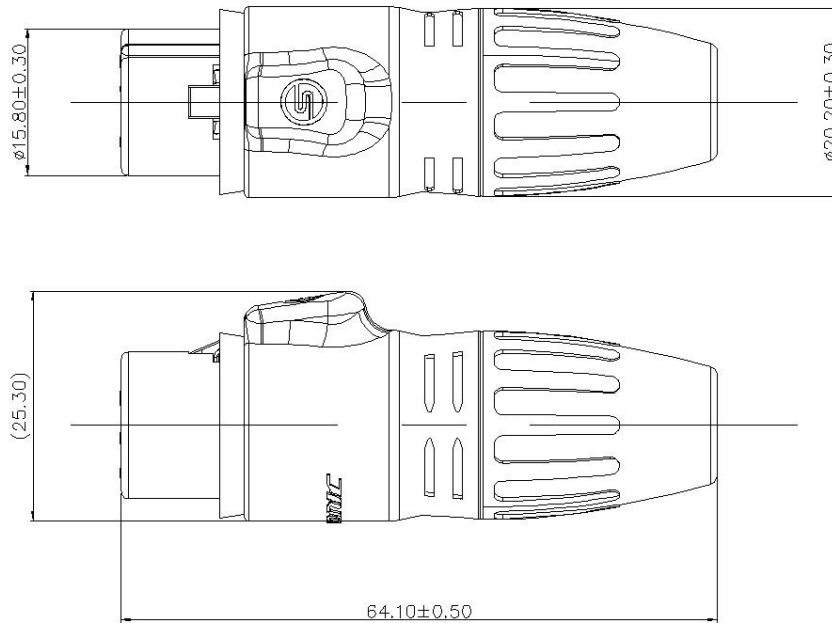

Unit: mm

Packaging Method

1 pc per bag (include 1 pc each of inner core, housing, waterproof cable clamp, boot)
80 pcs per inner carton, 5 inner cartons per master carton (400 pcs per master carton)

Accessory

- | | |
|--|--|
| <input checked="" type="checkbox"/> No accessories | <input type="checkbox"/> Back fastener plate |
| <input type="checkbox"/> Screws and Nuts | <input type="checkbox"/> Other |



Product Data Sheet

Assembly Instructions

(1) Put the cable through the boot and waterproof cable clamp

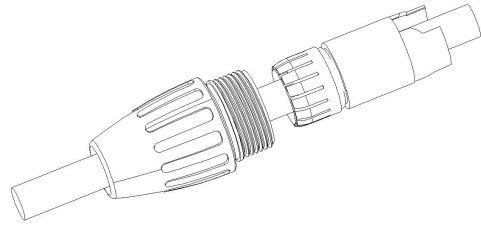

(2) Strip the cable in the size as shown

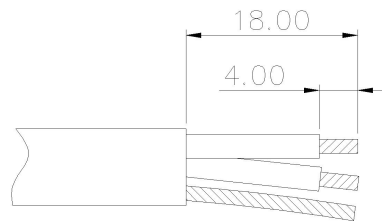

(3) Insert the conductor of the cable into the terminal of the inner core and solder

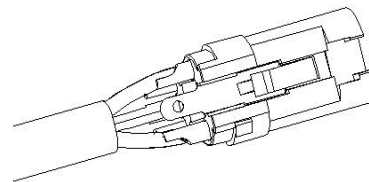

(4) Snap the clamp into the inner core assembly bayonet

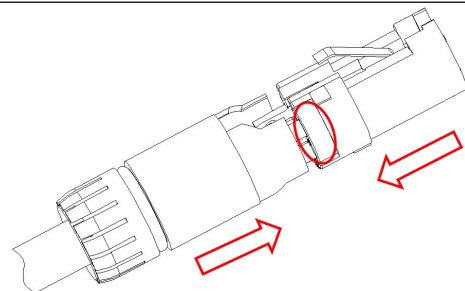

Product Data Sheet

- (5) Push the inner core component and clamp into the housing. The two protruding ribs of the inner core component should correspond to the two grooves inside the housing.

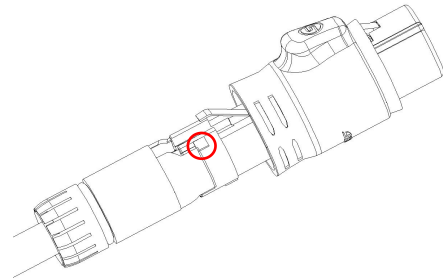

- (6) After the assembly of the cable clamp, inner core and housing, tighten the boot in a clockwise direction.

