



LUMA-NET

400CP REMOTE CONTROL PANEL

INSTALLATION AND OPERATION GUIDE

Software Revision 3.00, Version C

INTRODUCTION

The NSI 400CP represents a key part of a state of the art, total lighting control system. Combined with NSI dimmers and optionally, an NSI memory control console, a totally integrated system is achieved.

The 400CP can automatically take control of up to 512 dimmer channels. Control is automatically passed between 400CP's and the memory control console as desired. The 400CP is exceptionally easy to operate and features 4 zone control with programmable fade times. Remote lockout capability is also included. Installation is a snap with the simple 4 wire digital connection required.

IMPORTANT

- Programming differs from older 400CP panels (prior to release 3.00), please read instructions.
- 400CP control panels with software release 3.00 and higher are not directly compatible and will not operate with older 400CP panels with software prior to release 3.00. Contact dealer or factory for modifications if necessary.
- NSI dimming systems used with these release 3.00 panels require the following software releases:

2408CD, 2408CR, 2404CD	release 2.30 and above.
DDS 8600/8800/9600/9800	release 1.30 and above. *
DDS 6000	release 1.30 and above. *
DDS 5300/5500/5600	release 1.30 and above. *

* Optional interface kit required for these units.

WIRING

The 400CP will only operate with NSI dimming and control systems explicitly designed for interfacing with it. Communication between the 400CP and the dimming system is via a 4 wire interface. Three wires carry the RS 422/485 bi-directional data. A fourth wire carries the DC voltage necessary for powering the unit.

Wiring cable between the 400CP and the dimming system is class 2 and should be at least 22 AWG, 4 conductor shielded, twisted pairs. (BELDEN 8302, 8723; 22 AWG.)

The 400CP may be connected to the dimming system via parallel or daisy-chained wiring. Due to power supply current demands, 400CP's must be limited to 5 units per daisy chain run with 22 awg wire, or 10 units with 20 AWG wire.

The Luma-net panels feature plug on wiring terminals. The terminals may be unplugged from the panel to facilitate ease of wiring and testing. Connect the terminals marked remote+, remote-, common, and +15 VDC to the same respective terminals on the dimming system and other 400CPs. Use one twisted pair for remote+ and remote- and the other pair for common and +15 VDC.

The wiring to the remote lockout switch, if used, can be simple 2 conductor 22 AWG. Connect the wires from the switch to the lockout+ and lockout- terminals. Any panel or group of panels may be locked-out remotely by interrupting the +15V supply to the panels. This should not affect any other panels still powered, or affect lighting levels currently set.

IMPORTANT: Verify wiring is correct before powering system! Make sure nothing conductive may touch pc board or components!

MOUNTING

The 400CP will mount in any standard double-gang electrical box with the 4 screws provided. See below paragraph on system turn-on before final mounting of panels.

SYSTEM TURN-ON

It is very important that the system operation be verified one panel at a time. Else, an improper connection at one panel would cause the entire system to not operate properly and may be difficult to diagnose.

After all terminal plugs have been wired and the dimmer system has been installed and tested, the installer is ready to connect each panel to the system. Panels may be plugged-in while system is live, but the installer must take care not to touch PC board or connections with fingers or metal objects. On daisy-chain runs, the panels closest to the dimming system should be connected first.

400CP panels without dip switches must have their network ID programmed after the power is connected. The panels that are provided with dipswitches should have the ID set before the system is powered. It is recommended that the installer review the programming procedures for network ID before proceeding. **A duplicate network ID number will cause the entire network to malfunction.**

Connect the first panel and immediately notice whether the POWER LED comes on, indicating power to the panel. The BUSY LED should come on momentarily and then go out and stay out. This indicates a successful reconfiguration of the network. If the BUSY LED flashes slowly, this indicates a duplicate ID number or wiring problem. Program the ID number, if not already, and observe the BUSY LED. (Note, the busy LED also flashes quickly when the program jumper is removed).

Now test the dimmer function by programming one scene or zone and operating the panel. If the dimmer responds, then mount the panel and proceed to the next panel in the system and follow the same procedure .

LEDS

The PWR LED indicates the presence of +15VDC to the panel.

The BUSY LED indicates the following:

- | | |
|----------------------------|---|
| Off | Normal state when there is no activity. |
| Short Blinks | A message is being sent on the network. |
| Steady on or Slow flashing | Network trying to reconfigure (bad ID?) |

While programming, the following actions are normal.

- | | |
|------------------|-------------------------------------|
| Quickly flashing | Programming mode, no mode selected. |
| Off | Programming mode, mode selected. |

LOCKOUT

Any 400CP may be disabled from operation with a remote key switch or other contact closure. Several Luma-net panels of the same version may be connected to the same contacts in parallel as long as polarity is maintained.

Closing the contact will prevent connected panels from operating, regardless of button presses.

Luma-net panels may also be locked out by causing a switch to disconnect the +15V supply to the panels.

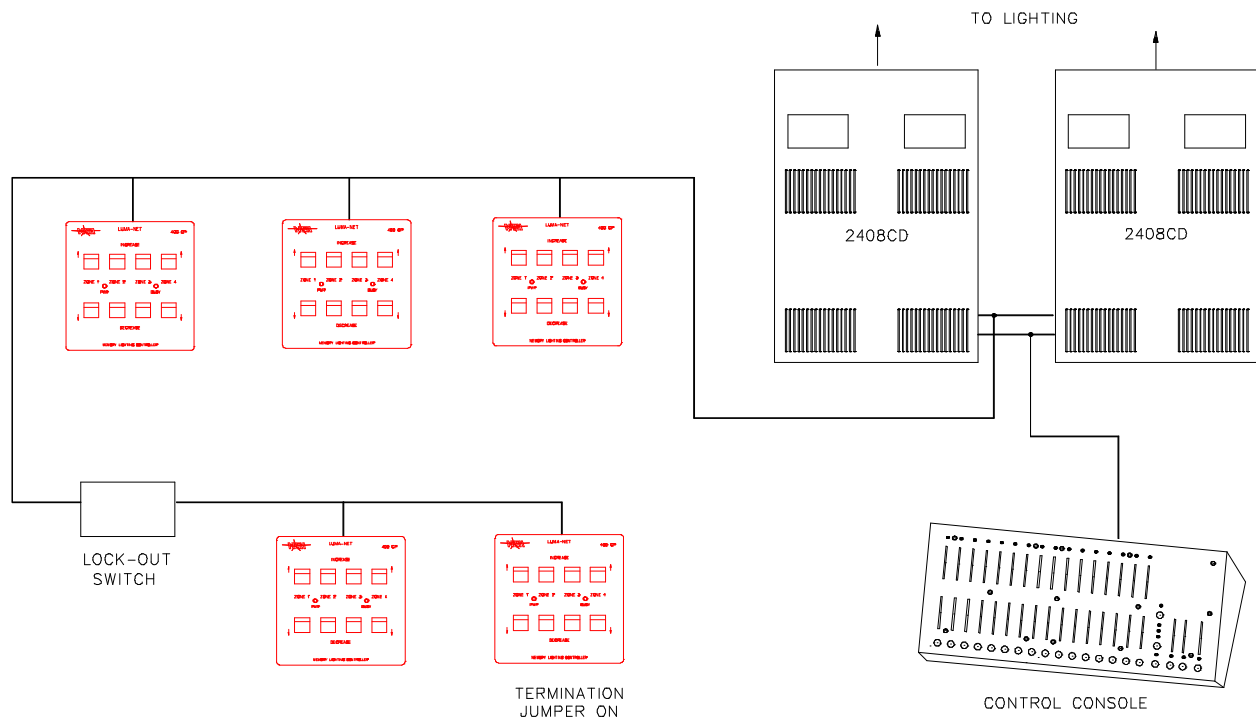

PROGRAMMING

Several parameters must be programmed into the 400CP for it to operate properly:

Maximum number of dimmers channels.

Dimmer channel assignments for each zone.

Fade time for each zone.

Master / Slave Mode.

Network ID number (IMPORTANT).

Optionally, the unit may be ordered preprogrammed from the factory. Any field modifications can be made if necessary.

Factory Default Setting:

The 400CP is programmed at the factory for zone 1-4 to be set for channel 1-4 respectively. The fade rate and other parameters are also set to factory defaults. This may be acceptable for initial testing. If necessary to return the 400CP panel to its factory default settings (except network ID), follow this procedure:

1. Remove program jumper block and disconnect plug-in terminal block.
2. Hold down all ZONE 1-4 LOWER buttons while connecting terminal block.

Full Memory Clear:

Normally, the 400CP will not require memory clearing. Once the memory is cleared, all parameters, including fade rate, must be reprogrammed. Unless it is necessary to clear memory to remove a large or unknown programming, skip these steps.

1. Remove program jumper block and disconnect terminal block.
2. Hold down all ZONE 1-4 RAISE buttons while connecting the terminal block.

Prepare the 400CP for reprogramming:

In order to program the 400CP, a jumper block must be removed from the program jumper pins (See diagram). This will allow data to be stored in the eeprom memory. At this point the BUSY LED will start flashing, indicating that you are in the program select mode.

IMPORTANT: After programming it is important to replace the programming jumper block so memory will be protected.

Maximum number of dimmers.

This parameter must be set to reflect a number greater than or equal to the maximum number of dimmer channels installed in the system. The factory default is 32 dimmer channels. If this number is correct then this step may be ignored.

The maximum number of dimmers may be set as follows:

1. Make sure that the 400CP is in the program select mode as discussed.
2. Press the zone 1 increase button and the BUSY led will quit flashing.
3. Press button representing desired number of dimmers as shown in the diagram.
4. If more than 256 dimmers are required then press a second button so that the sum of the values of the two buttons pressed will equal the desired number of dimmers.
5. The unit will exit this programming mode and the BUSY LED will start flashing again on release of the second press, or after a few seconds if only one press was required.

MAXIMUM NUMBER OF DIMMERS

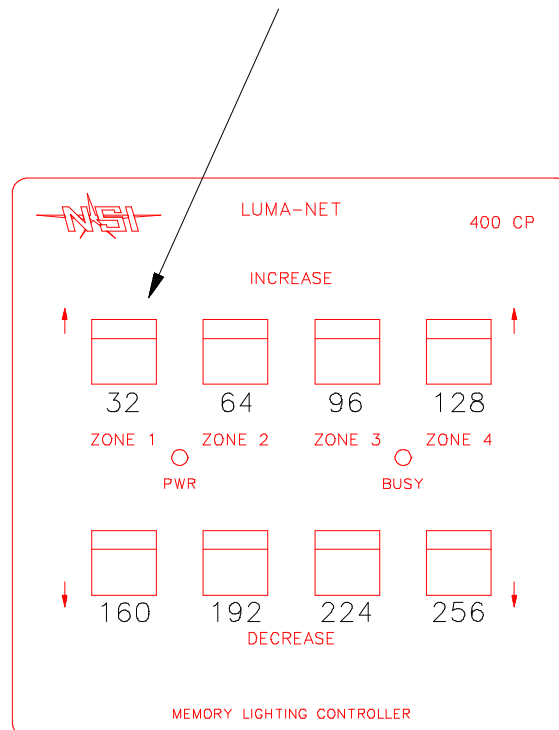

Assigning dimmer channels to each scene.

Each of the zones of the 400CP must be programmed with the desired dimmer channel assignments. Only the dimmer channels assigned will be affected by each zone's increase and decrease buttons.

In order to easily identify dimmer channels while programming, the system should have all installed lamps or loads operational. If this is not possible, the 400CP to be programmed should be temporarily connected nearby to the dimmer units so that the control LEDs of the dimmers may be observed to verify channel selection.

To program each zone:

1. Make sure that the 400CP is in the program select mode as discussed. The BUSY LED should be flashing.
2. Press the zone 2 increase button to select "dimmer assignment mode" and the BUSY LED will stop flashing.
3. Press INCREASE button representing desired zone to be programmed. At this point, all currently assigned dimmers will come on. The current dimmer selector will be set to one.
4. Use the buttons marked as UP and DOWN in diagram to increment or decrement the dimmer channel selector. Tap the buttons the required number of times to reach the dimmer channel to be assigned.
5. Use the ADD and DELETE buttons to add or delete this dimmer from the zone. The lamps connected to this dimmer channel will come on full when the ADD button is pressed. Observe lamps or dimmer LEDs to verify correct channel has been selected.
6. A new zone can be programmed at any time by pressing the appropriate zone INCREASE button. The dimmer selector number will always return to one when changing zones.
7. To exit this programming mode; press both the UP and DOWN buttons at the same time. The BUSY LED will start flashing again when both buttons are then released.

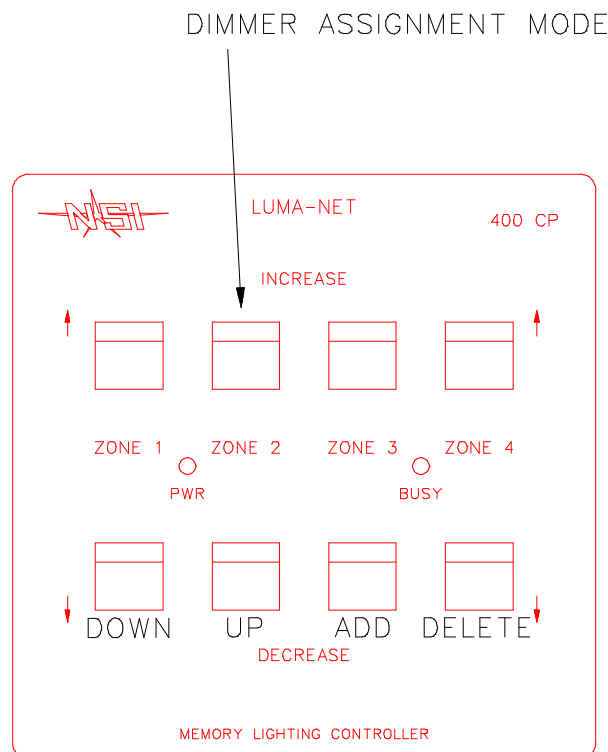

Zone fade time programming.

Each zone may be programmed with an individual fade time. This is the time it will take the dimmer channels assigned to go from full off to full on and visa versa. Fade time can vary from 0 to 13 seconds. A longer fade time will increase the accuracy when using the increase and decrease buttons to set desired lighting levels. A fade time of 0 seconds will cause instant full on or full off operation whenever the increase or decrease buttons are pressed. If the factory default setting of 5 seconds is desired for each zone then this step may be ignored.

To program zone fade time:

1. Make sure that the 400CP is in the program select mode as discussed.
2. Press the zone 3 increase button to enter "fade time mode" and the BUSY LED will stop flashing.
3. Select the desired zone by pressing the associated button as shown in the diagram.
4. Press button marked with desired fade time in seconds.
5. Unit will exit this programming mode after the release of the button and the BUSY LED will start flashing again.

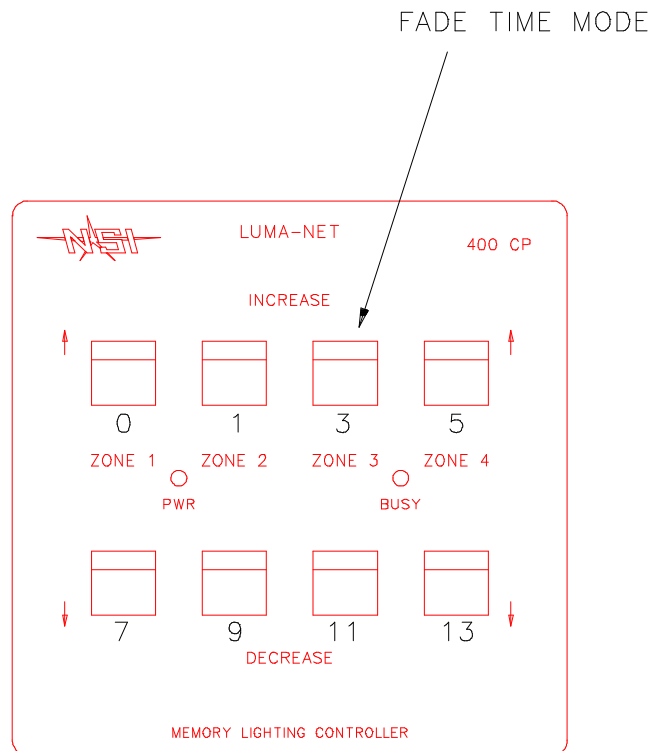

Master/Slave Mode .

400CP panels may be slaved to one another. Several panels may act as slaves to a master panel which contains the programming. The slaves will mimic the master LED's and will operate the scenes and fade times of the master. This is ideal for installations with several panels in one room.

To make a panel into a master (factory default); set the Master/Slave ID to 0. To make a panel into a slave; set the Master/Slave ID to the Network ID of the desired master to slave to.

To set Master/Slave ID number:

1. Make sure that the 400CP is in the program mode as discussed.
2. Press the zone 4 increase button and the BUSY LED will stop flashing
3. Look up the necessary sequence of 1's and 0' for the ID number on the chart at the end of this section.
4. Using the two buttons indicated below, enter the eight number sequence of 1's and 0's.
5. The unit will exit this program mode at the release of the eighth press, and the BUSY LED will start flashing again.

NOTE : All other programming (except network ID) will have no effect if unit is made into a slave. The master unit will contains the programming for all units slaved to it. Slave units must also still have a unique Network ID number (see following section).

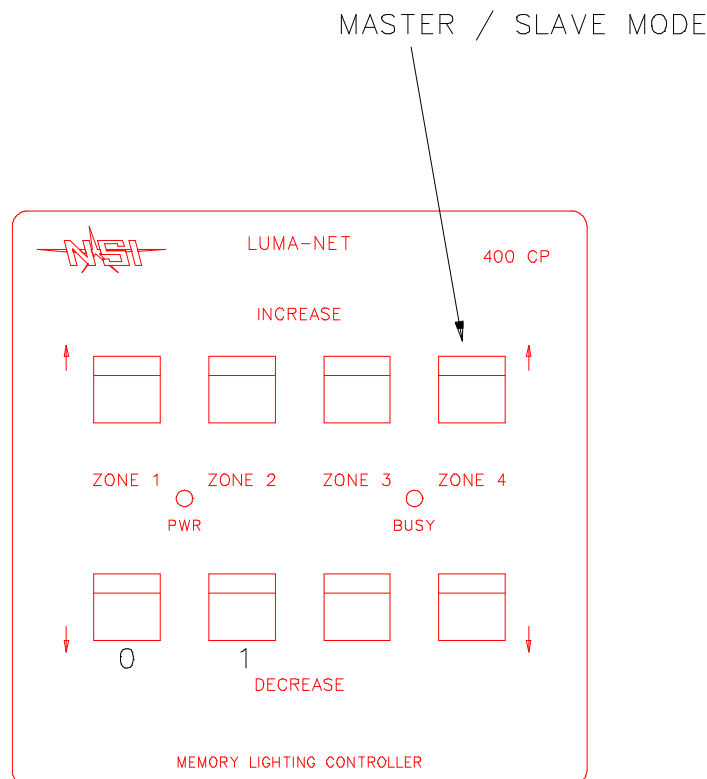

Network ID number.

Since the Luma-net System is a digital network, all panels and devices attached (except dimmers) must have a unique network ID number.

If two panels have the same network ID number, the entire network will stop functioning.

Panels without a dipswitch must follow this procedure otherwise simply set the dipswitch as per the chart on the following page.

To set Network ID number (units without dipswitch):

1. Make sure that the 400CP is in the program mode as discussed.
2. Press the zone 1,2,3,4 increase buttons at the same time and the BUSY LED will stop flashing
3. Look up the necessary sequence of 1's and 0' for the ID number on the chart at the end of this section.
4. Using the two buttons indicated below, enter the eight number sequence of 1's and 0's.
5. The unit will exit this program mode at the release of the eighth press, and the BUSY LED will start flashing again.

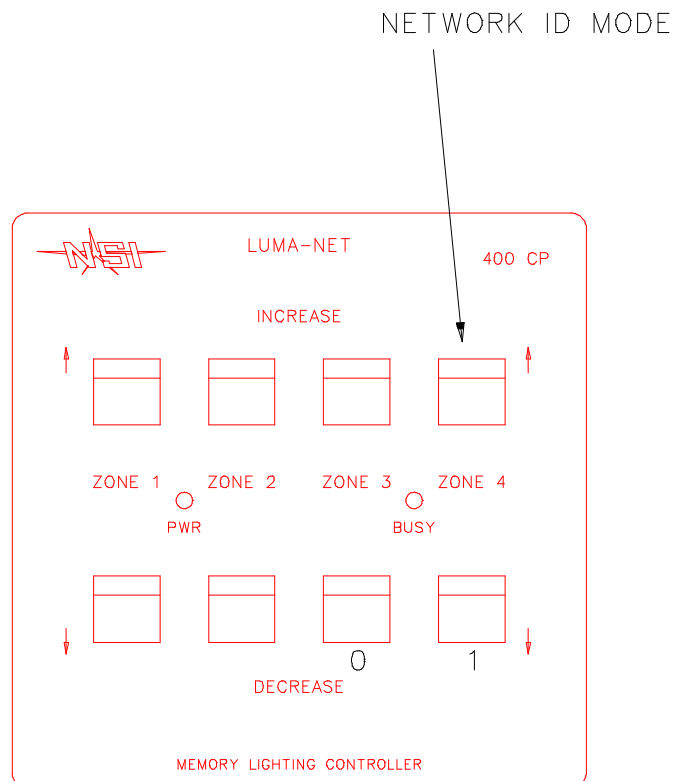

ID number codes / dipswitch settings

ID number	12345678	ID number	12345678	ID number	12345678
0	00000000	1	10000000	2	01000000
3	11000000	4	00100000	5	10100000
6	01100000	7	11100000	8	00010000
9	10010000	10	01010000	11	11010000
12	00110000	13	10110000	14	01110000
15	11110000	16	00001000	17	10001000
18	01001000	19	11001000	20	00101000
21	10101000	22	01101000	23	11101000
24	00011000	25	10011000	26	01011000
27	11011000	28	00111000	29	10111000
30	01111000	31	11111000	32	00000100
33	10000100	34	01000100	35	11000100
36	00100100	37	10100100	38	01100100
39	11100100	40	00010100	41	10010100
42	01010100	43	11010100	44	00110100
45	10110100	46	01110100	47	11110100
48	00001100	49	10001100	50	01001100
51	11001100	52	00101100	53	10101100
54	01101100	55	11101100	56	00011100
57	10011100	58	01011100	59	11011100
60	00111100	61	10111100	62	01111100
63	11111100	64	00000010	65	10000010
66	01000010	67	11000010	68	00100010
69	10100010	70	01100010	71	11100010
72	00010010	73	10010010	74	01010010
75	11010010	76	00110010	77	10110010
78	01110010	79	11110010	80	00001010
81	10001010	82	01001010	83	11001010
84	00101010	85	10101010	86	01101010
87	11101010	88	00011010	89	10011010
90	01011010	91	11011010	92	00111010
93	10111010	94	01111010	95	11111010
96	00000110	97	10000110	98	01000110
99	11000110	100	00100110	101	10100110
102	01100110	103	11100110	104	00010110
105	10010110	106	01010110	107	11010110
108	00110110	109	10110110	110	01110110
111	11110110	112	00001110	113	10001110
114	01001110	115	11001110	116	00101110
117	10101110	118	01101110	119	11101110
120	00011110	121	10011110	122	01011110
123	11011110	124	00111110	125	10111110
126	01111110	127	11111110		

For channels 129 - 256 Set dipswitch 1-7 as above and set dipswitch #8 on.

OPERATION

To raise lighting levels:

Press and hold the increase button of the zone desired. The 400cp will then take control of all dimmer channels assigned to the selected zone and increase lighting levels at the programmed fade rate. Release button when correct lighting levels are attained.

To lower lighting levels:

Press and hold the decrease button of the zone desired. The 400cp will then take control of all dimmer channels assigned to the selected zone and decrease lighting levels at the programmed fade rate. Release button when correct lighting levels are attained.

To restore control from a console:

Simply perform a change in the channel level from the console. The lighting channel will then fade back to the new console level at the same fade rate as last commanded by the 400CP for that channel. Once the console level matches or is moved past the lighting level, full console control will be resumed for that channel.

REAR VIEW OF 400CP UNITS

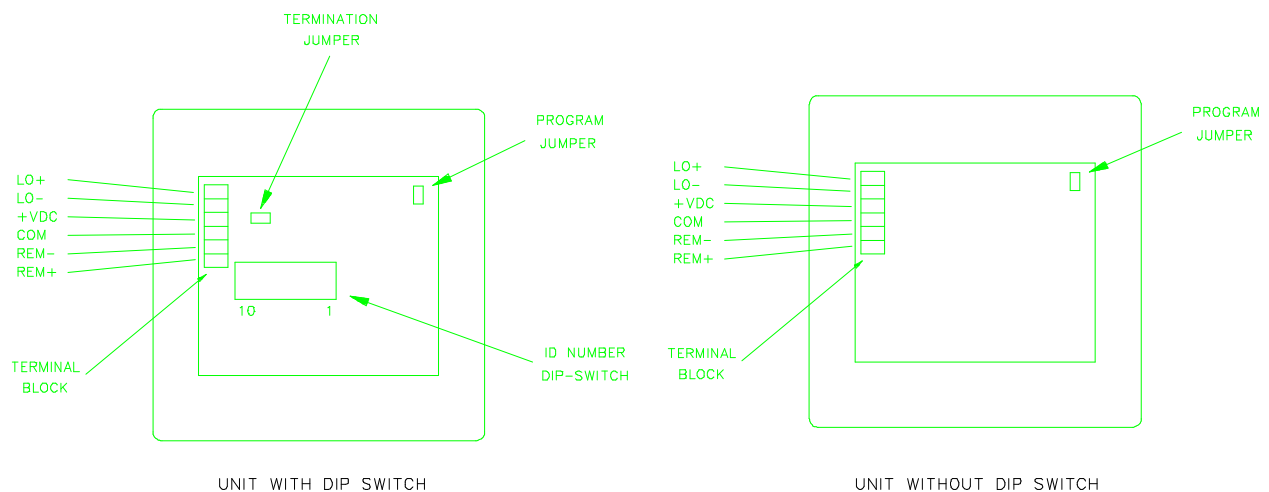

WARRANTY

NSI Corporation Limited Warranty

NSI Corporation warrants new electronics products to be free from defective materials and workmanship for a period of one (1) year from the date of purchase to the original owner when purchased from an authorized NSI dealer.

The purchaser is responsible for completing and mailing to NSI, within 15 days of purchase, the warranty registration card enclosed with each product. NSI products that have been subject to accident, alteration, abuse, or defacing of the serial number are not covered by this warranty. The normal wear and tear of items such as knobs, jacks, and switches are not covered under this warranty.

If your NSI product requires service during the warranty period, NSI will repair or replace, at its option, defective materials provided you have identified yourself as the original owner of the product to NSI or any authorized NSI dealer. Transportation charges to and from an authorized dealer or the NSI factory for repair shall be the responsibility of the owner. All products returned to NSI must have factory authorization for return prior to shipping.

NSI Corporation is not liable for any incidental or consequential damages resulting from defect or failure other than repairs of the NSI product subject to the terms of this warranty. This warranty gives you specific legal rights, and you may have other rights which vary from state to state. This warranty is expressly in lieu of all other agreements and warranties expressed or implied except as may be otherwise required by law.