

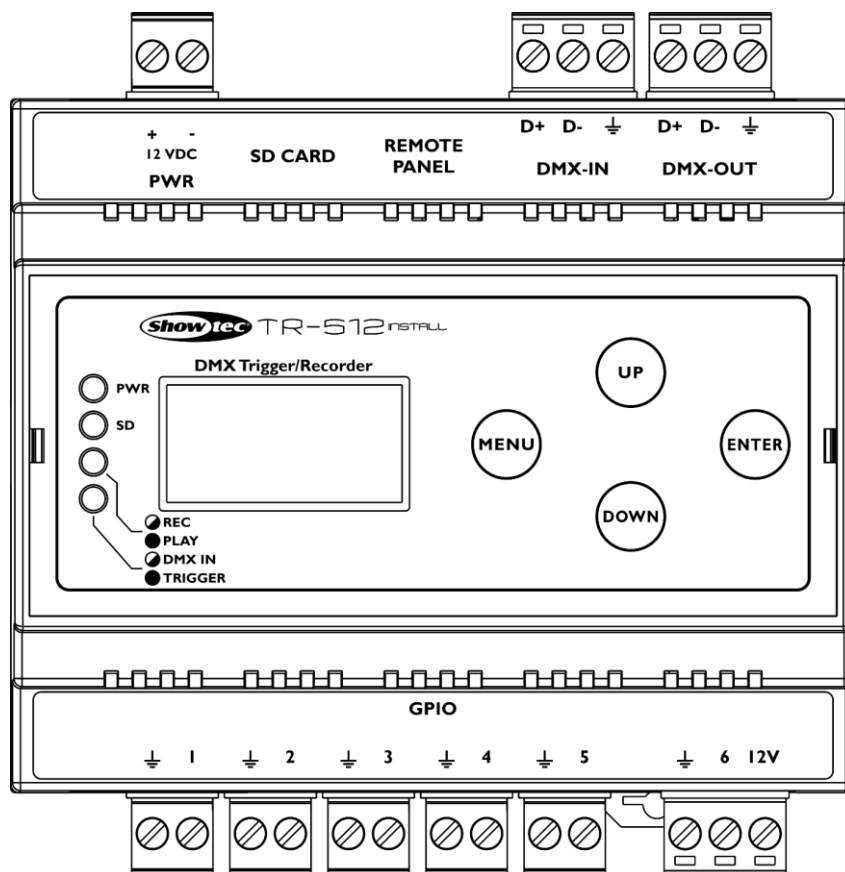

# USER MANUAL



ENGLISH

## TR-512 Install

V2

Product code: 50826

### Preface

---

Thank you for purchasing this Showtec product.

The purpose of this user manual is to provide instructions for the correct and safe use of this product.

Keep the user manual for future reference as it is an integral part of the product. The user manual shall be stored at an easily accessible location.

This user manual contains information concerning:

- Safety instructions
- Installation and operation of the device
- Intended and non-intended use of the device
- Maintenance procedures
- Troubleshooting
- Transport, storage and disposal of the device

Non-observance of the instructions in this user manual may result in serious injuries and damage of property.

©2021 Showtec. All rights reserved.

No part of this document may be copied, published or otherwise reproduced without the prior written consent of Highlite International.

Design and product specifications are subject to change without prior notice.

For the latest version of this document or other language versions, please visit our website [www.highlite.com](http://www.highlite.com) or contact us at [service@highlite.com](mailto:service@highlite.com).

Highlite International and its authorized service providers are not liable for any injury, damage, direct or indirect loss, consequential or economic loss or any other loss arising from the use of, or inability to use or reliance on the information contained in this document.

## Table of contents

<b>Introduction</b> .....	<b>4</b>
1.1. Before Using the Product .....	4
1.2. Intended Use .....	4
1.3. Text Conventions .....	4
1.4. Symbols and Signal Words .....	5
1.5. Symbols on the Information Label .....	5
<b>Safety</b> .....	<b>6</b>
2.1. Warnings and Safety Instructions .....	6
2.2. Requirements for the User .....	7
<b>Description of the Device</b> .....	<b>8</b>
3.1. Front View .....	8
3.2. Product Specifications .....	9
3.3. Optional Accessories .....	9
3.4. Dimensions .....	10
<b>Installation</b> .....	<b>11</b>
4.1. Safety Instructions for Installation .....	11
4.2. Installation Site Requirements .....	11
4.3. DIN Rail Mounting .....	11
4.4. Connecting to Power Supply .....	12
<b>Setup</b> .....	<b>13</b>
5.1. Warnings and Precautions .....	13
5.2. DMX Connection .....	13
5.2.1. DMX-512 Protocol .....	13
5.2.2. DMX Cables .....	13
5.3. Setup Examples .....	14
5.3.1. Program Recording Setup .....	14
5.3.2. Program Playing Setup .....	15
5.3.2.1. Connecting External Trigger Devices .....	16
5.3.2.2. Connecting the Wall Panel .....	17
<b>Operation</b> .....	<b>18</b>
6.1. Safety Instructions for Operation .....	18
6.2. Start-up .....	19
6.3. Control Panel .....	19
6.4. Recording a Program .....	19
6.5. Playing a Program .....	20
6.6. Trigger Monitoring .....	20
6.7. LED Statuses .....	20
6.8. Menu Overview .....	21
6.9. Main Menu Options .....	22
6.9.1. Play Show .....	22
6.9.1.1. Show .....	22
6.9.1.2. Playback Mode .....	23
6.9.2. Record Show .....	23
6.9.2.1. Name .....	23
6.9.2.2. Record Mode .....	24
6.9.3. Delete Show .....	24
6.9.4. Trigger Event .....	25
6.9.4.1. Status .....	25
6.9.4.2. Rename .....	25
6.9.4.3. Show .....	26
6.9.4.4. Trigger Mode .....	26
6.9.4.5. Delay .....	26

6.9.5. Stop TR Event .....27

6.9.6. Blackout File.....27

6.9.7. Device Settings .....28

    6.9.7.1. Device Label.....28

    6.9.7.2. DMX Trigger Option.....29

    6.9.7.3. DMX Port Option.....29

    6.9.7.4. Display Option .....30

    6.9.7.5. Version.....30

6.9.8. Save Configuration .....31

6.9.9. Load Configuration.....32

6.9.10. Default Setting .....32

6.10. DMX Channels.....32

**Troubleshooting .....33**

**Maintenance.....33**

    8.1. Preventive Maintenance .....33

        8.1.1. Basic Cleaning Instructions .....33

    8.1. Corrective Maintenance .....34

**Deinstallation, Transportation and Storage .....34**

**Disposal.....34**

**Approval.....34**

## Introduction

### 1.1. Before Using the Product



**Important**

**Read and follow the instructions in this user manual before installing, operating or servicing this product.**

The manufacturer will not accept liability for any resulting damages caused by the non-observance of this manual.

After unpacking, check the contents of the box. If any parts are missing or damaged, contact your Highlite International dealer.

Your shipment includes:

- Showtec TR-512 Install
- MicroSD card
- User manual

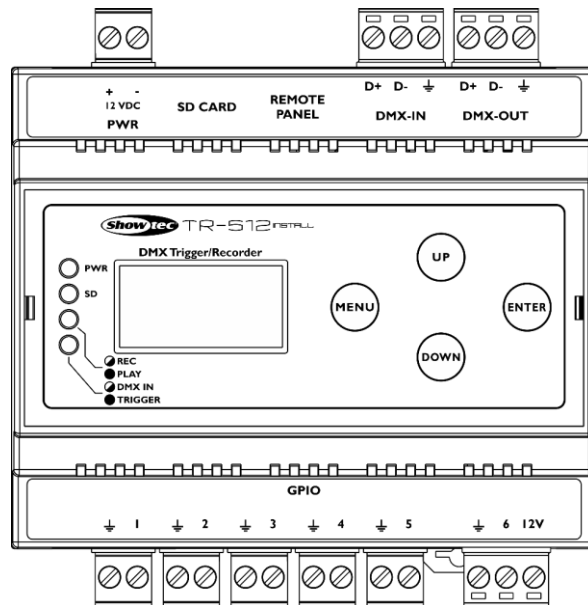

Fig. 01

### 1.2. Intended Use

This device is designed to be used as a professional DMX trigger/recorder. It is suitable for indoor installation in an electrical enclosure.

Any other use, not mentioned under intended use, is regarded as non-intended and incorrect use.

### 1.3. Text Conventions

Throughout the user manual the following text conventions are used:

- Buttons: All buttons are in bold lettering, for example “Press the **UP/DOWN** buttons”
- References: References to chapters and parts of the device are in bold lettering, for example: “Refer to **2. Safety**”, “press the **power switch (03)**”
- 0–255: Defines a range of values
- Notes: **Note:** (in bold lettering) is followed by useful information or tips

## 1.4. Symbols and Signal Words

Safety notes and warnings are indicated throughout the user manual by safety signs.

Always follow the instructions provided in this user manual.



**DANGER**

Indicates an imminently hazardous situation which, if not avoided, will result in death or serious injury.



**WARNING**

Indicates an imminently hazardous situation which, if not avoided, could result in death or serious injury.



**CAUTION**

Indicates a potentially hazardous situation, which, if not avoided, may result in minor or moderate injury.



**Attention**

Indicates important information for the correct operation and use of the product.



**Important**

Read and observe the instructions in this document.



Provides important information about the disposal of this product.



## 1.5. Symbols on the Information Label

This product is provided with an information label. The information label is located on the bottom plate of the device.

The information label contains the following symbols:



This device is designed for indoor use.



This device is IEC protection class III.



This device shall not be treated as household waste.



Read and observe the instructions in this document.

## Safety



### Important

**Read and follow the instructions in this user manual before installing, operating or servicing this product.**

The manufacturer will not accept liability for any resulting damages caused by the non-observance of this manual.

### 2.1. Warnings and Safety Instructions



#### Attention

#### Power supply

This device falls under IEC protection class III. This device shall be connected to an external power supply.

- Before connecting the device to the external power supply, make sure that the current, voltage and frequency match the input voltage, current and frequency specified on the information label on the device.
- Make sure that the cross-sectional area of the power cable is sufficient for the required power consumption of the device.



#### Attention

#### General safety

- Do not block the ventilation openings. Without proper heat dissipation and air circulation, the internal components may overheat. This can result in product damage.
- Do not shake the device. Avoid brute force when installing or operating the device.



#### Attention

#### For professional use only

**This device shall be used only for the purposes it is designed for.**

This device is designed to be used as a professional DMX trigger/recorder. It is suitable for indoor installation in an electrical enclosure. Any incorrect use may lead to hazardous situations and result in injuries and material damage.

- This device is not suitable for households.
- This device does not contain user-serviceable parts. Unauthorized modifications to the device will render the warranty void. Such modifications may result in injuries and material damage.



### **Attention**

**Do not expose the device to conditions that exceed the rated IP class conditions.**

This device is IP20 rated. IP (Ingress Protection) 20 class provides protection against solid objects greater than 12 mm, such as fingers, and no protection against harmful ingress of water.

## **2.2. Requirements for the User**

This product may be used by ordinary persons. Maintenance, installation and service shall be carried out only by instructed or skilled persons. Contact your Highlite International dealer for more information.

Instructed persons have been instructed and trained by a skilled person, or are supervised by a skilled person, for specific tasks and work activities associated with the service of this product, so that they can identify risks and take precautions to avoid them.

Skilled persons have training or experience, which enables them to recognize risks and to avoid hazards associated with the service of this product.

Ordinary persons are all persons other than instructed persons and skilled persons. Ordinary persons include not only users of the product but also any other persons that may have access to the device or who may be in the vicinity of the device.



## Description of the Device

The TR-512 Install is a compact but very powerful tool which can be used for triggering any light show or scene in a simple way. It can record and play several DMX programs at the same time. Those programs can be stored on a microSD card. Programs can be played by 6 external triggers or by the internal auto trigger. The TR-512 Install is suitable for a large range of venues, such as: theme parks, museums, shops and many others.

### 3.1. Front View

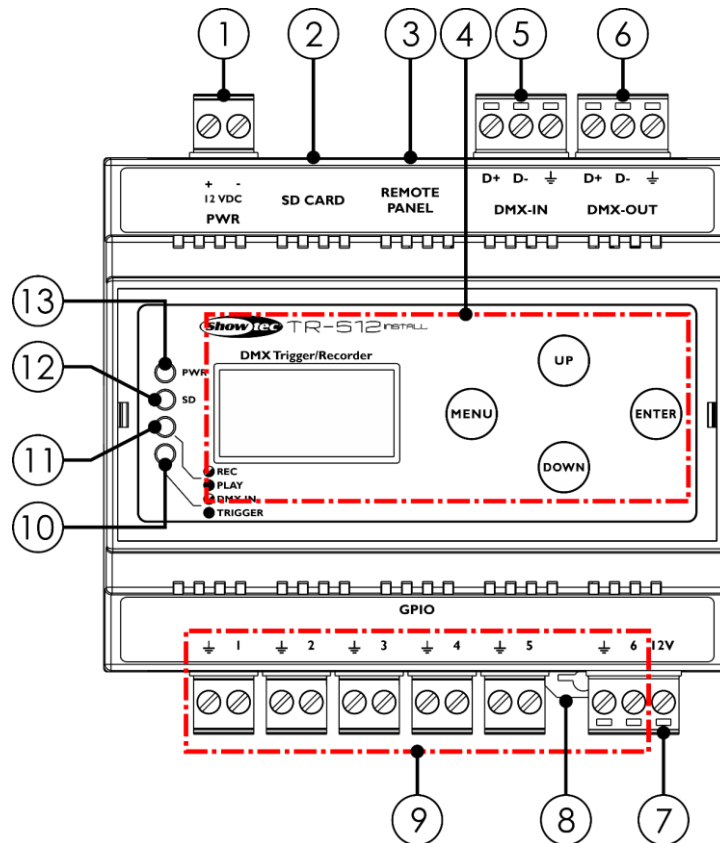

Fig. 02

- 01) 12 V DC 2-pin Phoenix terminal power connector IN
- 02) MicroSD card slot
- 03) Remote trigger connector RJ45 IN
- 04) OLED display + control buttons
- 05) 3-pin Phoenix terminal connector DMX IN
- 06) 3-pin Phoenix terminal connector DMX OUT
- 07) Optional 12 V output connector for external LED indicators
- 08) DIN rail lock
- 09) Triggers 1–5 (GPIO), 2-pin Phoenix terminal connector IN; Trigger 6 (GPIO), 3-pin Phoenix terminal connector IN
- 10) DMX IN/Trigger LED indicator (blue)
- 11) Play/Record LED indicator (green)
- 12) MicroSD LED indicator (yellow)
- 13) Power LED indicator (red)

### 3.2. Product Specifications

Model:	TR-512 Install
<b>Electrical:</b>	
Power supply (external):	12 V DC
Power consumption:	6 W
<b>Physical:</b>	
Dimensions:	105 x 110 x 58 mm (LxWxH)
Weight:	0,19 kg
<b>Operation and control:</b>	
Control protocols:	DMX-512
Control panel:	OLED display and buttons
Control modes:	DMX-512A, Wall Remote, GPIO, Manual
MicroSD card capacity:	8 GB
<b>Connections:</b>	
Power connections:	<ul style="list-style-type: none"> <li>• 12 V DC 2-pin Phoenix terminal power connector IN (maximum cable gauge: 1,5 mm<sup>2</sup> / AWG: 12)</li> <li>• 12 V Phoenix connector OUT (maximum cable gauge: 1,5 mm<sup>2</sup> / AWG: 12)</li> </ul>
Input connections:	<ul style="list-style-type: none"> <li>• 6 x 2-pin Phoenix terminal trigger GPIO connector IN (maximum cable gauge: 1,5 mm<sup>2</sup> / AWG: 12)</li> <li>• 3-pin Phoenix terminal DMX connector IN (maximum cable gauge: 1,5 mm<sup>2</sup> / AWG: 12)</li> <li>• RJ45 wall panel connector IN</li> </ul>
Output connections:	3-pin Phoenix terminal DMX connector OUT (maximum cable gauge: 1,5 mm <sup>2</sup> / AWG: 12)
<b>Construction:</b>	
Housing:	UL94-V0 flame retardant polycarbonate
Color:	Gray
Mounting:	35-mm DIN rail system (DIN EN43880 form factor; DIN EN60715 rail system)
Mounting size:	6 TE
IP rating:	IP20
<b>Thermal:</b>	
Ambient temperature $t_a$ :	40 °C

### 3.3. Optional Accessories

You can additionally purchase the following accessories:

Product code: [50827](#) (Wall Panel Remote for TR-512 Install/Pocket, Black)

Product code: [50828](#) (Wall Panel Remote for TR-512 Install/Pocket, Silver)

### 3.4. Dimensions

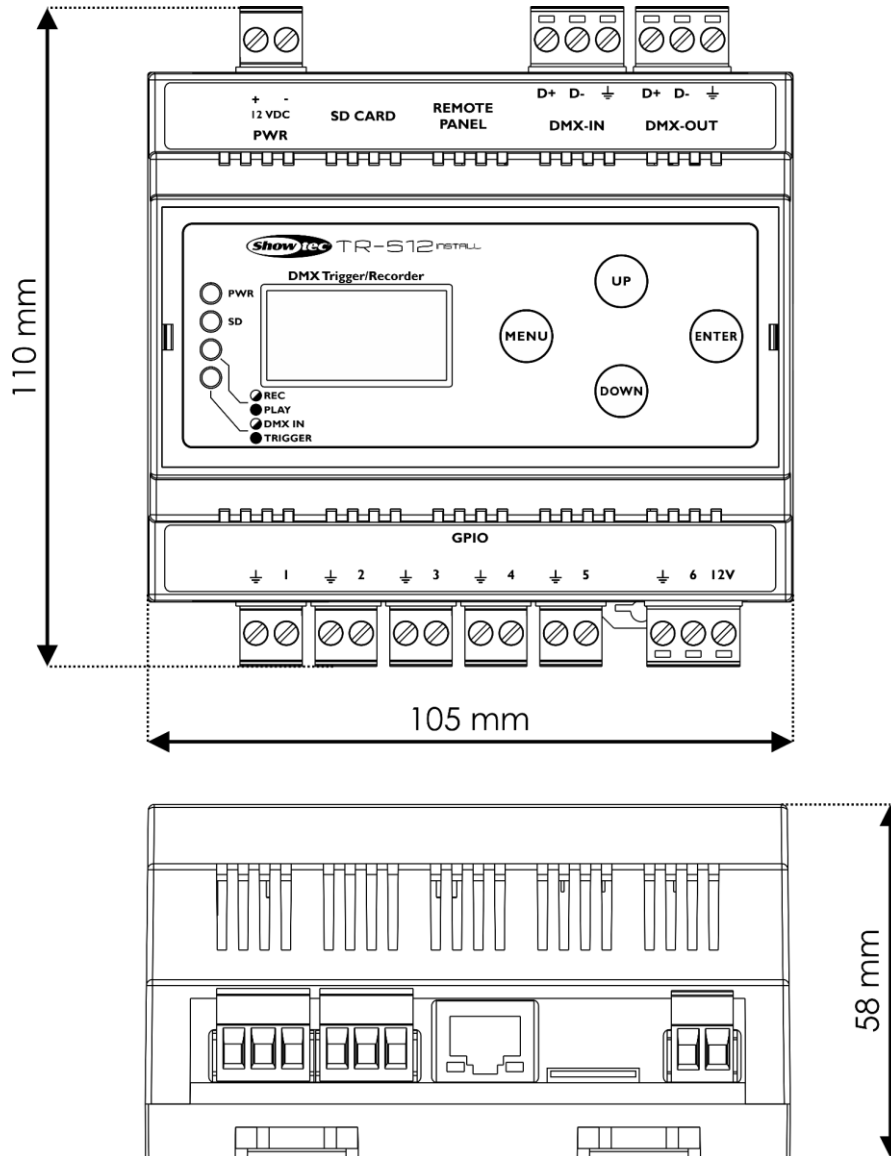

Fig. 03

## Installation

### 4.1. Safety Instructions for Installation



**WARNING**

Incorrect installation can cause serious injuries and damage of property.

The installation of this device shall be carried out only by instructed or skilled persons.

Before installing the device, make sure that the electrical enclosure, where the device will be mounted, is disconnected from power supply.

### 4.2. Installation Site Requirements

- The device must be installed only indoors.
- The device can be mounted on a 35-mm DIN rail.
- The maximum ambient temperature  $t_a = 40\text{ °C}$  must never be exceeded.
- The relative humidity must not exceed 50 % with an ambient temperature of 40 °C.

### 4.3. DIN Rail Mounting

The device can be mounted on a 35-mm DIN rail.

Make sure that the DIN rail is sufficiently secured to prevent it from becoming unstable or falling off.

To mount the device on a 35-mm DIN rail, follow the steps below:

- 01) Position the device on the DIN rail.
- 02) Push the **DIN rail locks (08)** to mount the device firmly on the DIN rail (see Fig. 04).

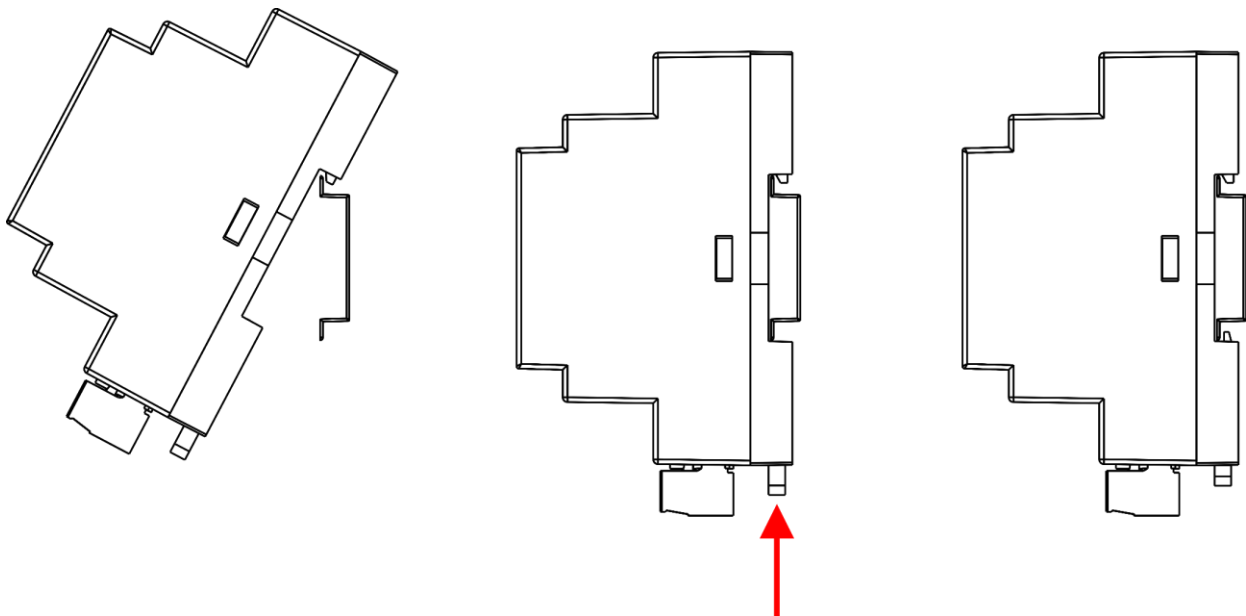

Fig. 04

#### 4.4. Connecting to Power Supply



**Attention  
Power supply**

This device falls under IEC protection class III. This device shall be connected to an external power supply.

- Before connecting the device to the external power supply, make sure that the current, voltage and frequency match the input voltage, current and frequency specified on the information label on the device.
- Make sure that the cross-sectional area of the power cable is sufficient for the required power consumption of the device.

01) Remove the **2-pin Phoenix terminal power connector IN (01)**.

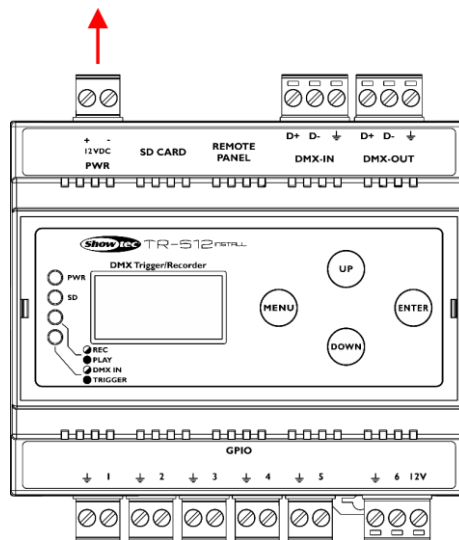

Fig. 05

02) Connect the external power supply to the Phoenix connector. Insert the cables correctly.

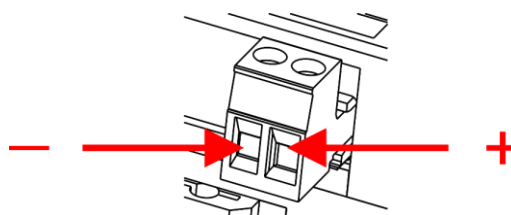

Fig. 06

- 03) Put the Phoenix connector back in the TR-512 Install.  
 04) Install the TR-512 Install on a DIN rail. See **4.3. DIN Rail Mounting** on page 11 for more information.  
 05) Connect the external power supply to the socket-outlet with its power plug.

## Setup

### 5.1. Warnings and Precautions



**Attention**

Connect all data cables before supplying power.  
Disconnect power supply before connecting or disconnecting data cables.

### 5.2. DMX Connection

#### 5.2.1. DMX-512 Protocol

Use a DMX-512 controller to create DMX programs and send them to the TR-512 Install where they will be stored on the microSD card.

The TR-512 Install has 3-pin DMX signal IN and OUT Phoenix terminal connectors.

The pin assignment is as follows:

- 3-pin: pin 1 (ground), pin 2 (-), pin 3 (+)

**Note:**

- Maximum recommended DMX data link distance: 300 m

#### 5.2.2. DMX Cables

Shielded twisted-pair cables must be used for reliable DMX connection. You can purchase DMX cables directly from your Highlite International dealer or make your own cables.

If you use XLR audio cables for DMX data transmission, this may lead to signal degradation and unreliable operation of the DMX network.

When you make your own DMX cables, make sure that you connect the pins and wires correctly as shown in Fig. 07 on page 13.

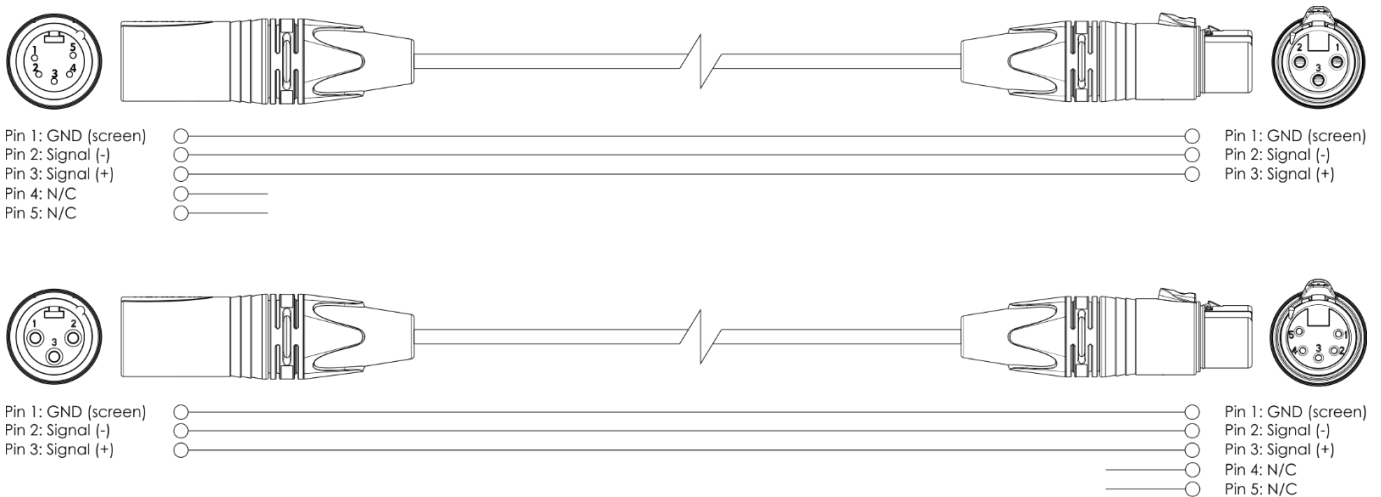

**Fig. 07**

### 5.3. Setup Examples

#### 5.3.1. Program Recording Setup

- 01) Remove the **3-pin Phoenix terminal DMX connector IN (05)** and the **3-pin Phoenix terminal DMX connector OUT (06)**.

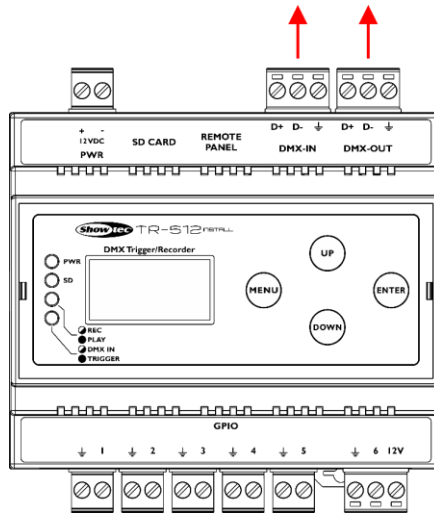

Fig. 08

- 02) Connect a DMX-512 light controller to the device's **3-pin Phoenix terminal DMX connector IN (05)** and connect light fixtures to the device's **3-pin Phoenix terminal DMX connector OUT (06)**.
- 03) Insert the cables correctly.

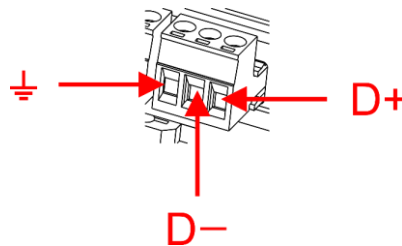

Fig. 09

- 04) Put the Phoenix connectors back in the device.

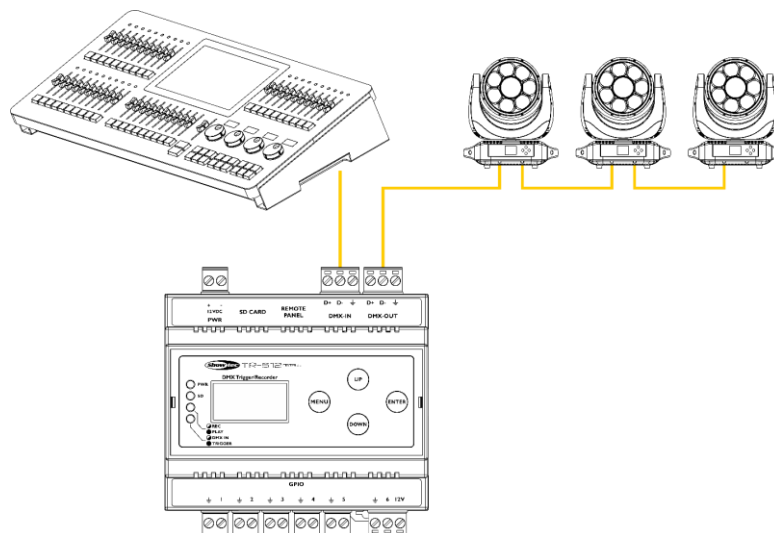

Fig. 10

- 05) Follow the instructions from **6.4. Recording a Program** on page 19.

5.3.2. Program Playing Setup

- 01) After recording, disconnect power supply from the devices.
- 02) Connect the external trigger devices. See **5.3.2.1. Connecting External Trigger Devices** on page 16 or **5.3.2.2. Connecting the Wall Panel** on page 17, for more information.
- 03) Follow the instructions from **6.5. Playing a Program** on page 20.

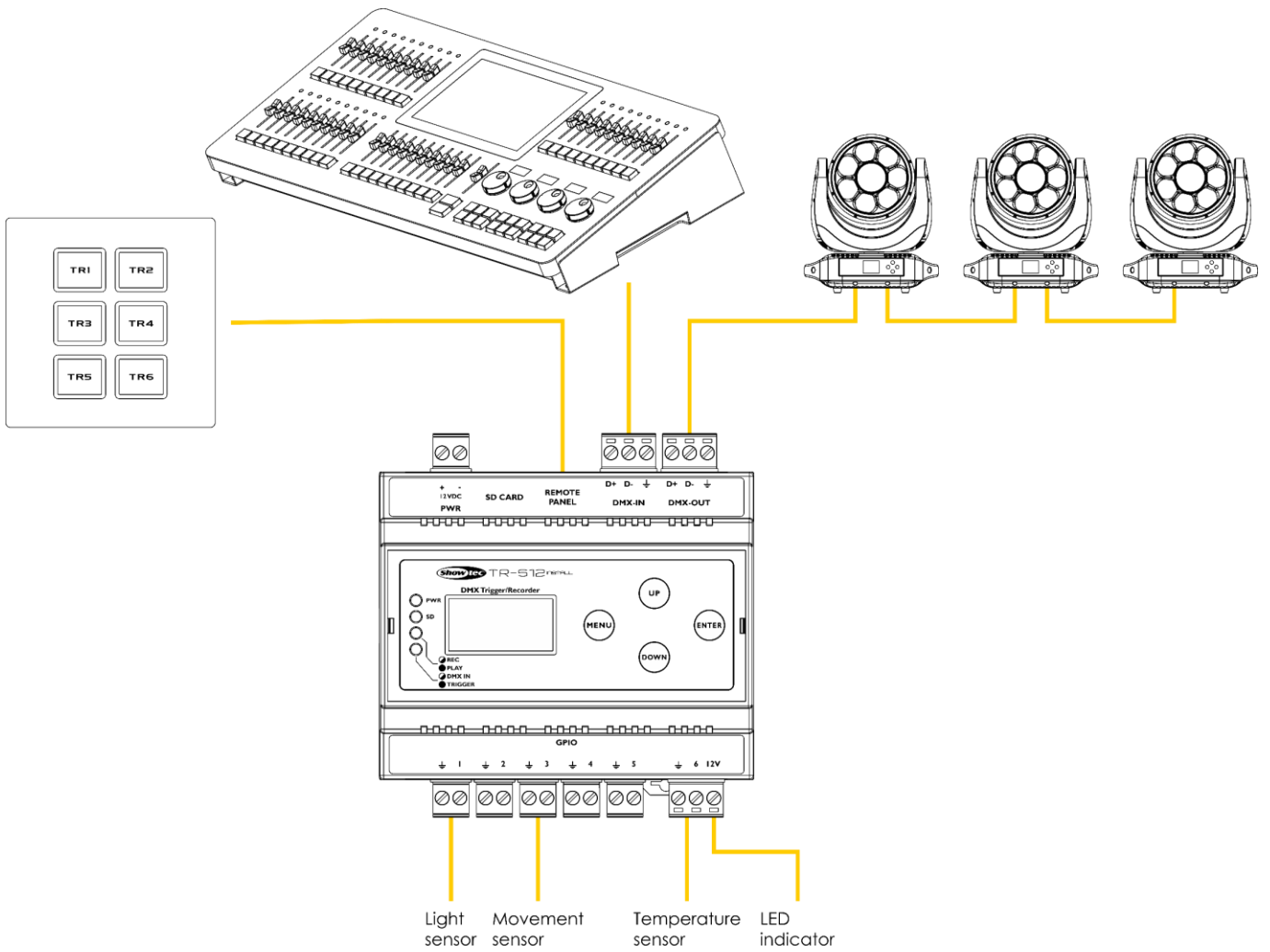

Fig. 11



5.3.2.1. Connecting External Trigger Devices

01) Remove the 2-pin 1–6 GPIO Phoenix terminal connectors IN (09).

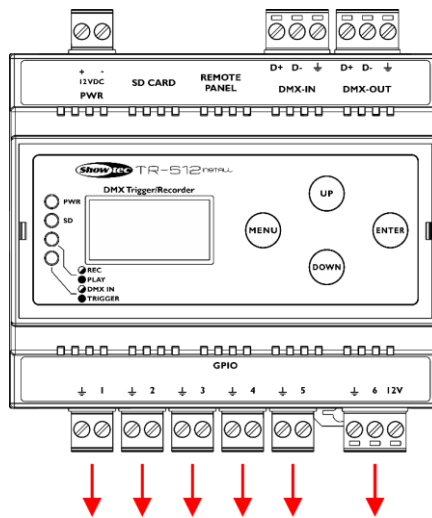

Fig. 12

02) Connect the desired external trigger devices (movement sensors, temperature sensors, light sensors, etc.) to the device's 2-pin 1–6 GPIO Phoenix terminal connectors IN (09).

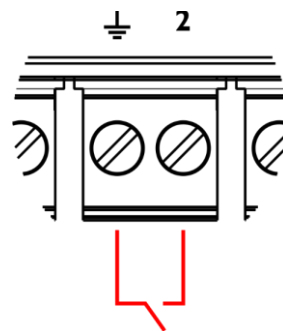

Fig. 13

03) Optionally, you can connect a 12 V device (e.g. a LED indicator) to the 6th GPIO Phoenix connector. For example, in Fig. 14, activating trigger 6 will also activate the connected 12 V device.

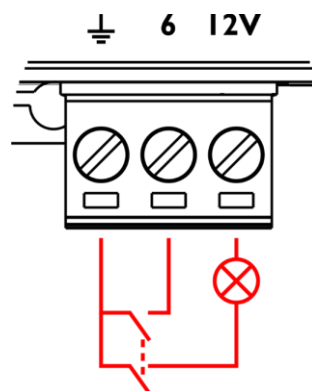

Fig. 14

04) Put the Phoenix connectors back in the device.

### 5.3.2.2. Connecting the Wall Panel

You can connect the optional Wall Panel Remote for TR-512 Install/Pocket (product code: 50827/50828) in order to trigger programs.

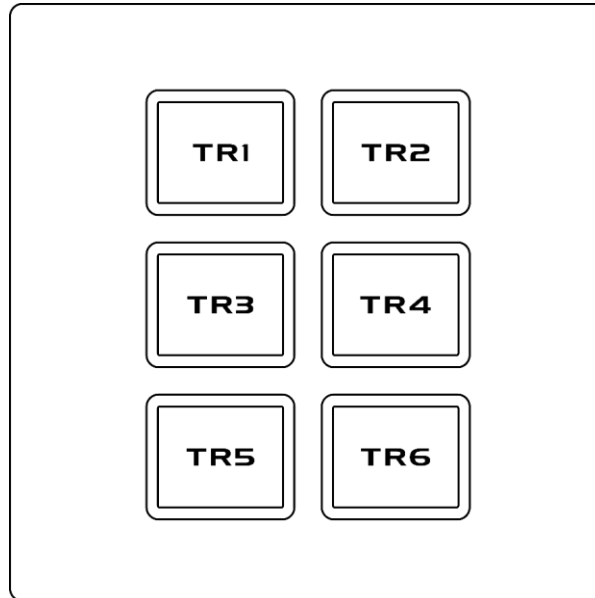

Fig. 15

- 01) Connect the wall panel to the device with an RJ45 cable. Recommended maximum cable length: 25 m.
- 02) Install the wall panel in two ways, with or without the jumper. See Fig. 16.
  - With the jumper: Set the TR-512 Install to TOGGLE\_TR. See **6.9.4.4. Trigger Mode** on page 26 for more information.
  - Without the jumper: Set the TR-512 Install to NO\_TR. See **6.9.4.4. Trigger Mode** on page 26 for more information.

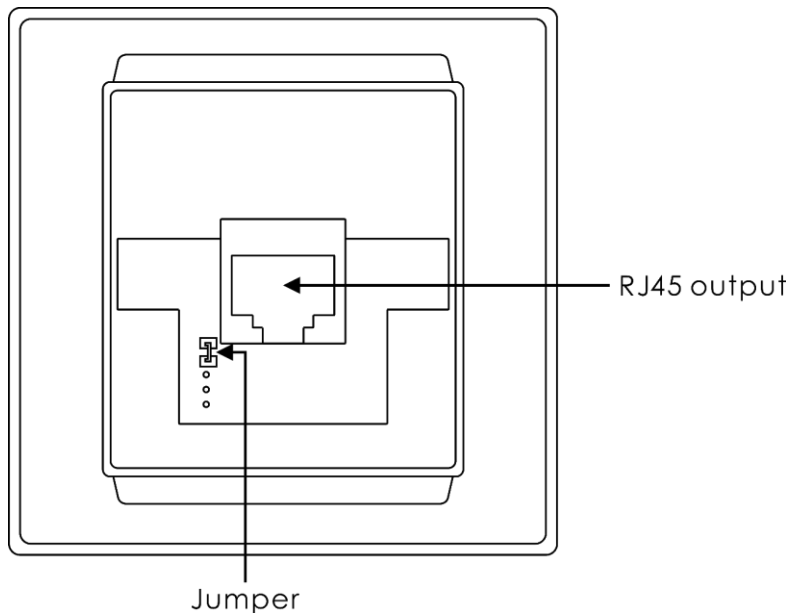

Fig. 16

03) Make sure that the RJ45 cable has the following pinout:

## Pinout

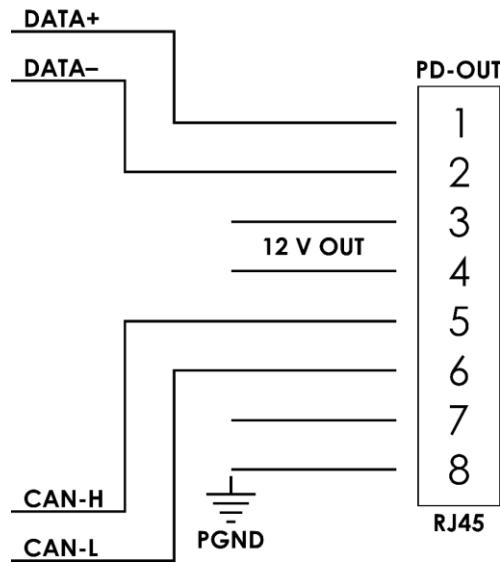

Fig. 17

## Operation

### 6.1. Safety Instructions for Operation



**Attention**

This device must be used only for the purposes it is designed for.

This device is designed to be used as a professional DMX trigger/recorder. It is suitable for indoor installation in an electrical enclosure. It is not suitable for households.

Any other use, not mentioned under intended use, is regarded as non-intended and incorrect use.



**Attention**

**Power supply**

Before connecting the device to the power supply, make sure that the current, voltage and frequency match the input voltage, current and frequency specified on the information label on the device.

## 6.2. Start-up

- 01) Before you power the device, insert the included microSD card into the **slot (02)**.
- 02) Power the device up. Upon start-up, the device will show the start screen:



- 03) Press the **MENU** button to enter the main menu. See **6.9. Main Menu Options** on page 22 for more information.
- 04) Press and hold down the **MENU** button for 2 seconds in order to return to the start screen (from any place in the menu).

### Note:

If the display is off, press any button to turn the display on. See **6.9.7.3. Display Option** on page 29 for more information.

## 6.3. Control Panel

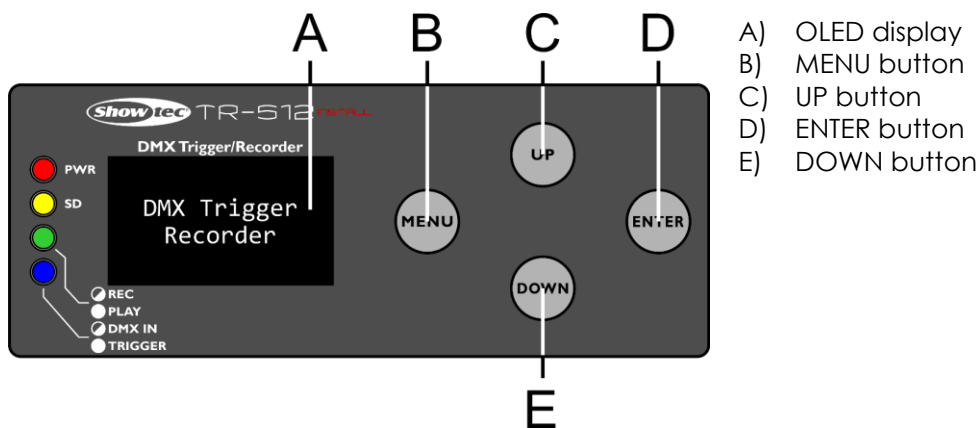

Fig. 18

- Use the **MENU** button to open the main menu, to exit the current submenu and to return to the main menu.
- Use the **UP/DOWN** buttons to navigate through the menus and to scroll through the available characters/numbers.
- Use the **ENTER** button to open the desired menu, to confirm your choice or to set the currently selected character/number.

## 6.4. Recording a Program

The device allows to record DMX programs and assign them to the 6 available triggers.

- 01) Connect a DMX-512 light controller and light fixtures to the device. See **5.3.1. Program Recording Setup** on page 14 for more information.
- 02) Make sure that the included microSD card is inserted into the device.
- 03) Record a program. See **6.9.2. Record Show** on page 23 for more information. During recording, the **LED indicator (11)** will be blinking. See **6.7. LED Statues** on page 20 for more information.
- 04) When you finished recording the program, disconnect the DMX-512 light controller.

## 6.5. Playing a Program

The device is equipped with 6 triggers to which you can assign your recorded programs. When a trigger is activated, the program assigned to this trigger will be played.

- 01) Connect the external triggers to the device. See **5.3.2. Program Playing Setup** on page 15 for more information.
- 02) Assign the recorded program to one of the 6 triggers. See **6.9.4. Trigger Event** on page 25 for more information.
- 03) Activate DMX triggering. See **6.9.7.2. DMX Trigger Option** on page 29 for more information.
- 04) Activate the external triggers, press the buttons on the Wall Panel Remote for TR-512 Install/Pocket or operate the DMX controller. The **LED indicator (10)** will blink once every time a trigger is activated. During playing programs, the **LED indicator (11)** will be on. See **6.7. LED Statuses** on page 20 and **6.10. DMX Channels** on page 32 for more information.

## 6.6. Trigger Monitoring

You can monitor the current status of each of the 6 triggers. You can access the trigger status menu only from the start screen.

- 01) Press and hold down the **MENU** button for 2 seconds in order to return to the start screen, from any place in the menu.



- 02) Repeatedly press the **UP/DOWN** buttons to see the status of each of the 6 triggers.

Trigger Status	
1.Name:	Trigger1
2.Show:	SHT001
3.Time:	00:03
4.Status:	Playing
5.Delay:	00:00

- 03) The display shows the following information:
  - NAME: Trigger's name
  - SHOW: Assigned DMX program's name
  - TIME: Playing time
  - STATUS: PLAYING (trigger is active) or WAITING (trigger is inactive)
  - DELAY: Delay time

## 6.7. LED Statuses

There are 4 LED indicators (**DMX IN/Trigger indicator (10)**, **Play/Record indicator (11)**, **MicroSD indicator (12)** and **Power indicator (13)**) on the control panel of the device. The LED indicators have the following functions:

- PWR: If the light is on, the device is powered.
- SD: If the light is on, the device is using the inserted microSD card to load/save data.
- REC/PLAY:
  - If the light is blinking, the device is recording a program.
  - If the light is on, the device is playing a program.
- DMX IN/TRIGGER:
  - If the light is blinking, the device is receiving a DMX signal.
  - If the light blinks once, a trigger is activated.

### 6.8. Menu Overview

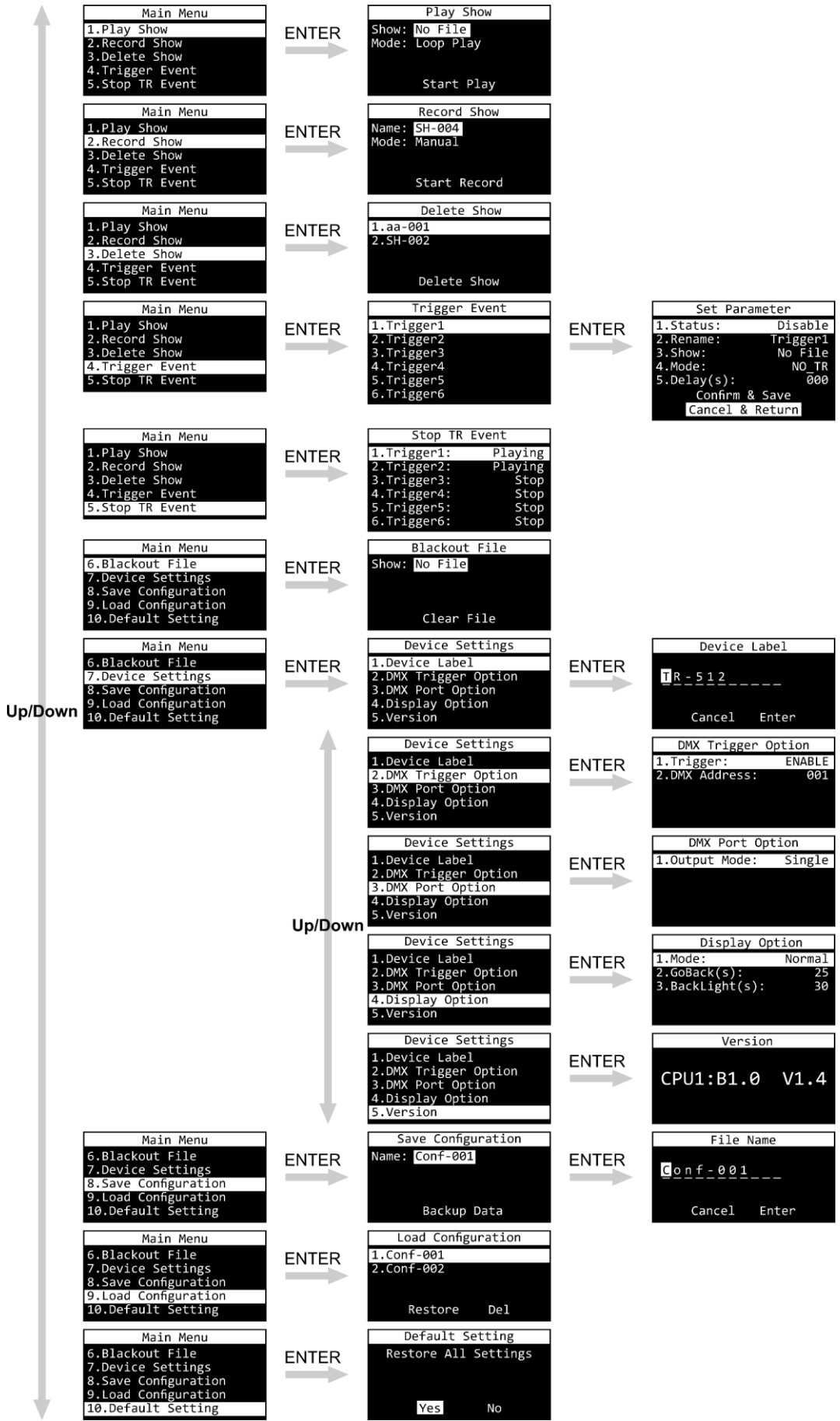

## 6.9. Main Menu Options

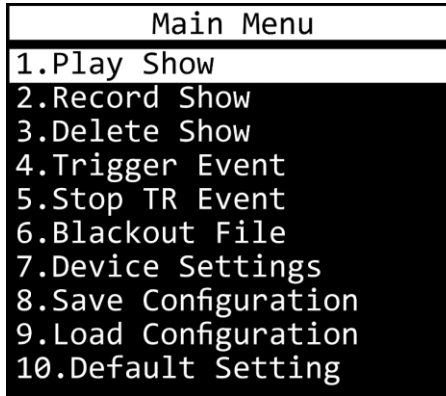

1. Play Show
2. Record Show
3. Delete Show
4. Trigger Event
5. Stop TR Event
6. Blackout File
7. Device Settings
8. Save Configuration
9. Load Configuration
10. Default Setting

- 01) Press the **UP/DOWN** buttons to toggle through the 10 menus.
- 02) Press the **ENTER** button to open the desired menu.

### 6.9.1. Play Show

In this menu you can play a recorded program. You can only play one program at a time.

**Note:**

You need to program at least one program in order to be able to play it. For more information, please read **6.9.2. Record Show**, page 23.

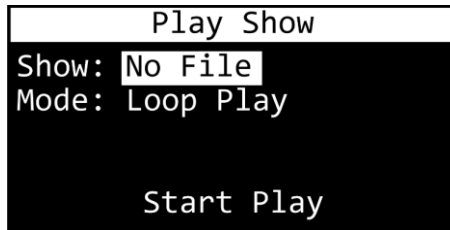

- 01) Press the **UP/DOWN** buttons to select one of the 2 submenus:
  - SHOW (See **6.9.1.1. Show** on page 22 for more information.)
  - MODE (See **6.9.1.2. Playback Mode** on page 23 for more information.)
- 02) Press the **ENTER** button to open the selected option.

#### 6.9.1.1. Show

In this submenu you can select the desired program.

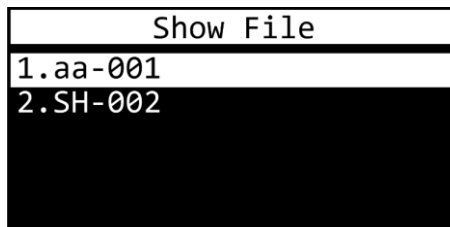

- 01) Press the **UP/DOWN** buttons to select the desired program.
- 02) Press the **ENTER** button to confirm your choice.

### 6.9.1.2. Playback Mode

In this submenu you can play the desired program.

- 01) Press the **UP/DOWN** buttons to select ONE PLAY (the program will be played once) or LOOP PLAY (the program will be played in a loop).
- 02) Press the **ENTER** button to confirm your choice.
- 03) Press the **UP/DOWN** buttons to select START PLAY and press the **ENTER** button. The device will now play the desired program.

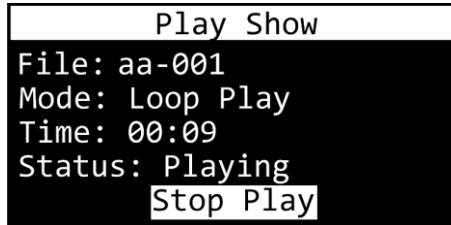

- 04) Press the **ENTER** button to stop playback.

### 6.9.2. Record Show

In this menu you can name and record programs.

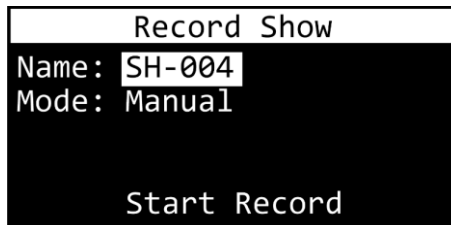

- 01) Press the **UP/DOWN** buttons to select one of the 2 submenus:
  - NAME (See **6.9.2.1. Name** on page 23 for more information.)
  - MODE (See **6.9.2.2. Record Mode** on page 24 for more information.)
- 02) Press the **ENTER** button to open the selected option.

#### 6.9.2.1. Name

In this submenu you can name programs.

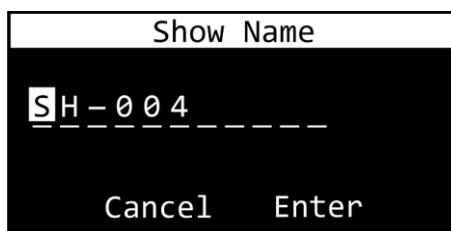

- 01) Press the **UP/DOWN** buttons to select the character you want to edit.
- 02) Press the **ENTER** button.
- 03) Press (or press and hold down, for quick search) the **UP/DOWN** buttons to select the desired character.
- 04) Press the **ENTER** button to confirm your choice.
- 05) Repeat steps 1–4 to edit the remaining characters.
- 06) Press the **UP/DOWN** buttons to select CANCEL (to cancel changes) or ENTER (to save the new file name).
- 07) Press the **ENTER** button to confirm your choice.



### 6.9.2.2. Record Mode

In this submenu you can set recording options.

- 01) Press the **ENTER** button to open the menu.
- 02) Press the **UP/DOWN** buttons to select one of the 4 recording modes:
  - **MANUAL:** Start and stop recording manually.
  - **AUTO\_START:** Start recording by setting all DMX channel values higher than 0 or deactivate Blackout on the light controller. Stop recording manually.
  - **AUTO\_STOP:** Start recording manually. Stop recording by setting all DMX channel values to 0 or activate Blackout on the light controller.
  - **AUTO:** Recording starts when the value of a DMX channel is higher than 0. Stop recording by setting all DMX channel values to 0 or activate Blackout on the light controller.
- 03) Press the **ENTER** button to confirm your choice.
- 04) Press the **UP/DOWN** buttons to select START RECORD.
- 05) Press the **ENTER** button to confirm.
- 06) If the display shows WAITING START, press the **ENTER** button again to start recording.
- 07) Press the **ENTER** button to stop recording. The recorded program will be saved.

### 6.9.3. Delete Show

In this menu you can remove the previously recorded programs.

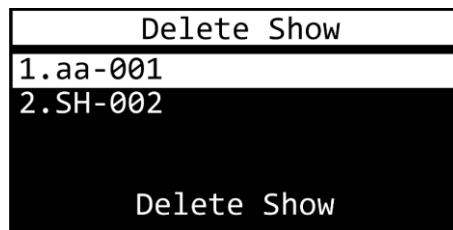

- 01) Press the **UP/DOWN** buttons to select the program you want to delete.
- 02) Press the **ENTER** button to confirm your choice. DELETE SHOW will illuminate.
- 03) Press the **ENTER** button to delete the program.
- 04) Repeat steps 1–3 to delete other programs.

If the program that you want to delete is assigned to any active trigger event, the device will display a message.

- 05) Press the **UP/DOWN** buttons to choose CONTINUE (to delete the program) or RETURN (to return to the previous menu)
- 06) Press the **ENTER** button to confirm your choice.

**6.9.4. Trigger Event**

In this menu you can set the trigger event settings.

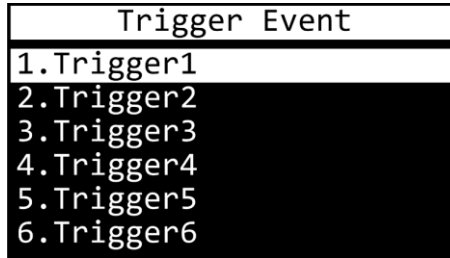

- 01) Press the **UP/DOWN** buttons to select the desired trigger.
- 02) Press the **ENTER** button to open the desired trigger's menu. The display will show:

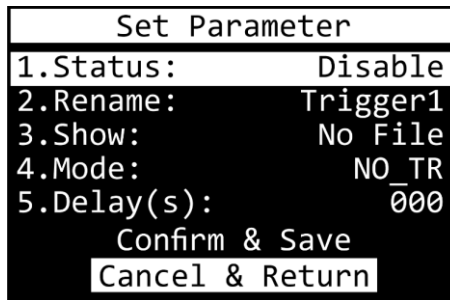

- 03) Press the **UP/DOWN** buttons to toggle through the 5 available submenus:
  - STATUS (See **6.9.4.1. Status** on page 25 for more information.)
  - RENAME (See **6.9.4.2. Rename** on page 25 for more information.)
  - SHOW (See **6.9.4.3. Show** on page 26 for more information.)
  - MODE (See **6.9.4.4. Trigger Mode** on page 26 for more information.)
  - DELAY (See **6.9.4.5. Delay** on page 26 for more information.)
- 04) Press the **ENTER** button to open the desired submenu.

Once you have adjusted all the options in menus **6.9.4.1–6.9.4.5**, save your trigger event.

- 05) Press the **UP/DOWN** buttons to select CONFIRM & SAVE (to save a new trigger event) or CANCEL & RETURN (to cancel changes and return to the previous menu).
- 06) Press the **ENTER** button to confirm your choice.

**6.9.4.1. Status**

In this submenu you can activate/deactivate the desired trigger event.

- 01) Press the **UP/DOWN** buttons to select ENABLE or DISABLE.
- 02) Press the **ENTER** button to confirm your choice.

**6.9.4.2. Rename**

In this submenu you can rename the trigger events.

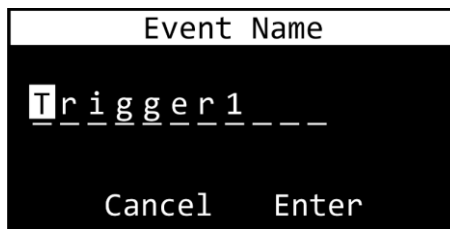

- 01) Press the **UP/DOWN** buttons to select the character you want to edit.
- 02) Press the **ENTER** button.

- 03) Press (or press and hold down, for quick search) the **UP/DOWN** buttons to select the desired character.
- 04) Press the **ENTER** button to confirm your choice.
- 05) Repeat steps 1–4 to edit the remaining characters.
- 06) Press the **UP/DOWN** buttons to select CANCEL (to cancel changes) or ENTER (to save the new name).
- 07) Press the **ENTER** button to confirm your choice.

#### 6.9.4.3. Show

In this submenu you can assign your recorded programs to the desired triggers.

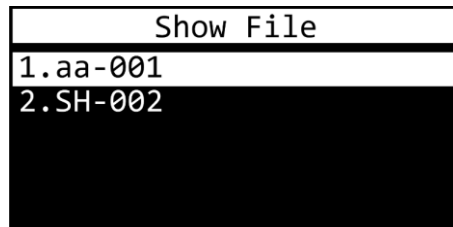

- 01) Press the **UP/DOWN** buttons to select the desired program from the list.
- 02) Press the **ENTER** button to confirm your choice.

#### 6.9.4.4. Trigger Mode

In this submenu you can set the trigger mode.

- 01) Press the **UP/DOWN** buttons to select one of the 4 trigger modes:
  - **NO\_TR** (Normally Open): Trigger will be activated when the circuit closes. As long as the circuit remains closed, the triggered program will play in a loop. When the circuit opens, the program will keep playing until it ends and then it will stop. With only a short pulse, the program will play just once.
  - **NC\_TR** (Normally Closed): Trigger will be activated when the circuit opens. As long as the circuit remains open, the triggered program will play in a loop. When the circuit closes, the program will keep playing until it ends and then it will stop. With only a short pulse, the program will play just once.
  - **TOGGLE\_TR**: It works with NO and NC circuits (external triggers). The first pulse starts the triggered program to play in a loop. After the second pulse, the program will stop. Another pulse will restart the program.
  - **AUTO\_TR**: The trigger will be activated immediately. Upon every start-up, the device will always search for any triggers set to this mode and will activate them.
- 02) Press the **ENTER** button to confirm your choice.

#### Note:

It is possible to use each of the 4 modes at the same time, independently, for separate triggers (1-6).

#### 6.9.4.5. Delay

In this submenu you can set the delay time.

- 01) Press the **UP/DOWN** buttons to set the delay time. The adjustment range is 0–120 seconds.
- 02) Press the **ENTER** button to save changes.

**6.9.5. Stop TR Event**

In this menu you can deactivate the trigger events.

Stop TR Event	
1.Trigger1:	Playing
2.Trigger2:	Playing
3.Trigger3:	Stop
4.Trigger4:	Stop
5.Trigger5:	Stop
6.Trigger6:	Stop

- 01) Press the **UP/DOWN** buttons to select one of the 6 trigger events.
- 02) Press the **ENTER** button to deactivate the selected trigger event.
- 03) Repeat steps 1–2 to deactivate the remaining trigger events, if needed.

**6.9.6. Blackout File**

In this menu you can set a blackout file.

Normally, when a show playback is finished, all DMX channels are set to 0 (default blackout). In other words, the device plays back a scene in which all DMX values are 0. If all your programmed shows use the same starting and ending positions/colors, it is not always convenient or necessary for the light fixtures to zero all their DMX settings after each show.

To prevent it, you can record a short show with the desired starting/ending settings and set it as your blackout file. The device will read only the first scene of this show, so it does not need to be longer than 1 second.

The device will now use your settings, instead of the default blackout, which will create smooth transitions between the shows.

**Note:**

You need to record a show to be able to use it as a blackout file. For more information, please read **6.9.2. Record Show**, page 23.

Blackout File	
Show:	No File
Clear File	

- 01) Press the **UP/DOWN** buttons to select SHOW.
- 02) Press the **ENTER** button to open the submenu. The display will show:

Show File	
1.	aa-001
2.	SH-002

- 03) Press the **UP/DOWN** buttons to select the desired show.

04) Press the **ENTER** button to confirm your choice. The display will show:

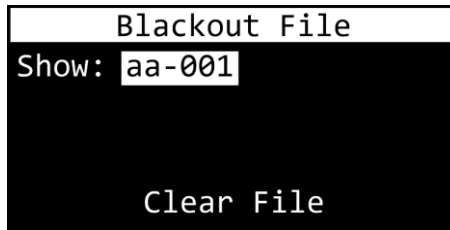

The blackout file is set and will be played between your shows.

If you do not need the blackout file anymore and want to use the default blackout, you need to uninstall the blackout file.

05) Press the **UP/DOWN** buttons to select CLEAR FILE and press the **ENTER** button to confirm. The device will now use the default blackout.

### 6.9.7. Device Settings

In this menu you can adjust the device's settings.

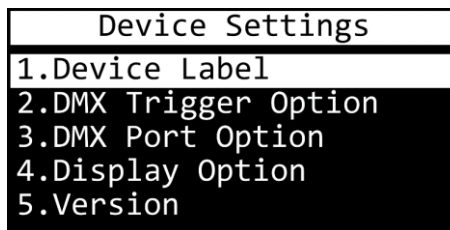

01) Press the **UP/DOWN** buttons to toggle through the 5 available submenus:

- DEVICE LABEL (See **6.9.7.1. Device Label** on page 28 for more information.)
- DMX TRIGGER OPTION (See **6.9.7.2. DMX Trigger Option** on page 29 for more information.)
- DMX PORT OPTION (See **6.9.7.3. DMX Port Option** on page 29 for more information.)
- DISPLAY OPTION (See **6.9.7.4. Display Option** on page 30 for more information.)
- VERSION (See **6.9.7.5. Version** on page 30 for more information.)

02) Press the **ENTER** button to open the desired submenu.

#### 6.9.7.1. Device Label

In this submenu you can rename the device label.



01) Press the **UP/DOWN** buttons to select the character you want to edit.

02) Press the **ENTER** button.

03) Press (or press and hold down, for quick search) the **UP/DOWN** buttons to select the desired character.

04) Press the **ENTER** button to confirm your choice.

05) Repeat steps 1–4 to edit the remaining characters.

06) Press the **UP/DOWN** buttons to select CANCEL (to cancel changes) or ENTER (to save the new name).

07) Press the **ENTER** button to confirm your choice.

### 6.9.7.2. DMX Trigger Option

In this submenu you can activate DMX control. You can use a DMX controller to activate the desired trigger events (1–6). Each trigger event can be started by setting corresponding DMX values.

DMX Trigger Option	
1.Trigger:	ENABLE
2.DMX Address:	001

- 01) Press the **UP/DOWN** buttons to select TRIGGER.
- 02) Press the **ENTER** button to open the menu.
- 03) Press the **UP/DOWN** buttons to select one of the 2 options:
  - **ENABLE:** Activates the function. Use a DMX controller to activate the desired trigger events.
  - **DISABLE:** Deactivates the function.
- 04) Press the **ENTER** button to confirm your choice.
- 05) Press the **UP/DOWN** buttons to select DMX ADDRESS.
- 06) Press the **ENTER** button to open the menu.
- 07) Press the **UP/DOWN** buttons to select a DMX starting address that will be used for trigger event activation. The adjustment range is 001–512. See **6.10. DMX Channels** on page 32 for more information.
- 08) Press the **ENTER** button to confirm your choice.

### 6.9.7.3. DMX Port Option

In this submenu you can adjust the port settings.

DMX Port Option	
1.Output Mode:	Single

- 01) Press the **ENTER** button to open the menu.
- 02) Press the **UP/DOWN** buttons to select one of the 2 output modes:
  - **SINGLE:** Only the last triggered program will be played.
  - **HTP (Highest Takes Precedence):** All triggered programs can be played simultaneously. The DMX values of each DMX channel are compared for all the triggered programs and they become merged into a DMX output signal, which contains only the highest value for each DMX channel.
- 03) Press the **ENTER** button to confirm your choice.

**6.9.7.4. Display Option**

In this submenu you can set the display options.

Display Option	
1.Mode:	Normal
2.GoBack(s):	25
3.BackLight(s):	30

- 01) Press the **UP/DOWN** buttons to select one of the 3 display modes:
  - **MODE:** Choose between **NORMAL** (normal view) and **INVERSE** (display flip). If you choose **INVERSE**, the button functions (**MENU/UP/DOWN/ENTER**) flip accordingly.
  - **GOBACK(S):** Set the time after which the display returns to the start screen, when no button is pressed. The adjustment range is between **NEVER** and **5–60** seconds, in increments of 5 seconds.
  - **BACKLIGHT(S):** Set the time which needs to pass, after which the display turns off. The adjustment range is between **ON** and **5–60** seconds, in increments of 5 seconds.
- 02) Press the **ENTER** button to open the desired submenu.
- 03) Press the **UP/DOWN** buttons to adjust settings.
- 04) Press the **ENTER** button to save changes.

**6.9.7.5. Version**

In this submenu you can view the current software version.

Version
CPU1:B1.0 V1.4

6.9.8. Save Configuration

In this menu you can create a backup of the device's settings. It will be saved on the microSD card.

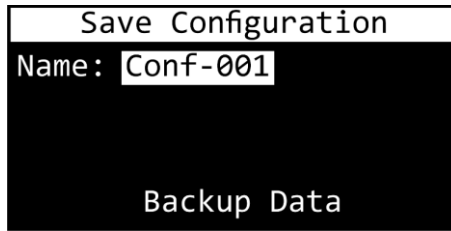

01) Press the **UP/DOWN** buttons to select NAME and press the **ENTER** button to edit the backup's name.



- 02) Press the **UP/DOWN** buttons to select the character you want to edit.
- 03) Press the **ENTER** button.
- 04) Press (or press and hold down, for quick search) the **UP/DOWN** buttons to select the desired character.
- 05) Press the **ENTER** button to confirm your choice.
- 06) Repeat steps 1–5 to edit the remaining characters.
- 07) Press the **UP/DOWN** buttons to select CANCEL (to cancel changes) or ENTER (to save the new name).
- 08) Press the **ENTER** button to confirm your choice.
- 09) Press the **UP/DOWN** buttons to select BACKUP DATA.
- 10) Press the **ENTER** button to create a configuration backup.

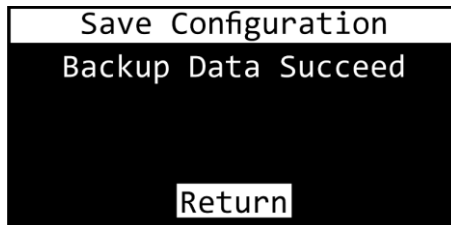

11) Press the **ENTER** button to return to the main menu.



### 6.9.9. Load Configuration

In this menu you can load or delete your configuration backup files.

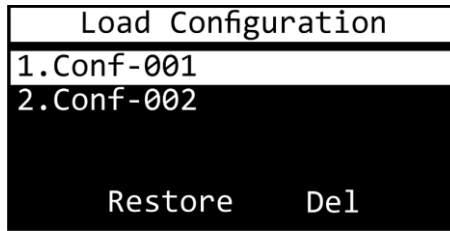

- 01) Press the **UP/DOWN** buttons to select the desired configuration backup file.
- 02) Press the **ENTER** button to confirm your choice.
- 03) Press the **UP/DOWN** buttons to choose between RESTORE (load the desired configuration backup file) and DEL (delete the desired configuration backup file).
- 04) Press the **ENTER** button to confirm your choice or press the **MENU** button if you do not want to use those functions and you want to return to the previous menu.

### 6.9.10. Default Setting

In this menu you can restore default factory settings.

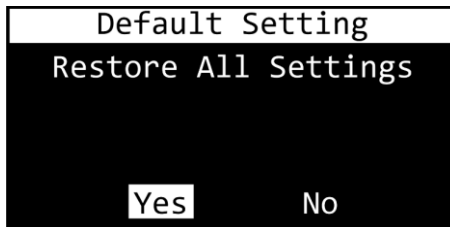

- 01) Press the **UP/DOWN** button to choose between the 2 options:
  - YES: The default factory settings will be restored. All settings of the current trigger events and all the display options will be set to default. The DMX PORT OPTION will be set to SINGLE. All saved programs and configuration files will not be reset.
  - NO: The device will return to the main menu.
- 02) Press the **ENTER** button to confirm your choice. The display will return to the main menu.

**Note:**

Turn the TR-512 Install off before removing the microSD card. Use the included microSD card to back up your data and transfer your files to a regular PC.

### 6.10. DMX Channels

Value	Setting
000-010	Stop trigger events
011-050	Run trigger event 1
051-090	Run trigger event 2
091-130	Run trigger event 3
131-170	Run trigger event 4
171-210	Run trigger event 5
211-251	Run trigger event 6
252-255	Stop trigger events

## Troubleshooting

This troubleshooting guide contains solutions to problems which can be carried out by an ordinary person. The device does not contain user-serviceable parts.

Unauthorized modifications to the device will render the warranty void. Such modifications may result in injuries and material damage.

Refer servicing to instructed or skilled persons. Contact your Highlite International dealer in case the solution is not described in the table.

Problem	Probable cause(s)	Solution
The device does not function at all	No power to the device	<ul style="list-style-type: none"> <li>• Check if power is switched on and cables are plugged in</li> <li>• Check if the external power supply is connected properly and if it is operating within its specification limits</li> </ul>
No DMX data transfer	The factory settings of the device are changed	<ul style="list-style-type: none"> <li>• Reset the device's parameters to the default factory settings. See <b>6.9.10. Default Setting</b> on page 32</li> </ul>
	Bad data link connection	<ul style="list-style-type: none"> <li>• Examine connections and cables. Correct poor connections. Repair or replace damaged cables</li> </ul>
	The signal is reversed. The DMX OUT of the controller does not match the DMX IN of the device	<ul style="list-style-type: none"> <li>• Install a phase-reversing cable between the controller and the device</li> </ul>

## Maintenance

Maintenance and cleaning shall be carried out only by instructed persons.

Follow the maintenance schedule established for the site where the electrical enclosure is installed.

Disconnect power supply before servicing or cleaning.

### 8.1. Preventive Maintenance



**Attention**  
Before use, examine the device visually for any defects.

Make sure that:

- All screws used for installing the device or parts of the device are tightly fastened and are not corroded.
- There are no deformations on housings, fixations and installation points.
- The power cables are not damaged and do not show any material fatigue.

#### 8.1.1. Basic Cleaning Instructions

To clean the device, follow the steps below:

- 01) Disconnect the electrical enclosure from the power supply.
- 02) Clean the device with a soft, lint-free cloth.
- 03) Remove residual dust with an air-duster or air-blower. Keep the air-duster or air-blower at a minimum distance of 30 cm.



### Attention

- Do not immerse the device in liquid.
- Do not use alcohol or solvents.

## 8.1. Corrective Maintenance

The device does not contain user-serviceable parts. Do not open the device and do not modify the device.

Refer repairs and servicing to instructed or skilled persons. Contact your Highlite International dealer for more information.

## Deinstallation, Transportation and Storage

- Disconnect the electrical enclosure, where the device is mounted, from the power supply before deinstallation of the device.
- Use the original packaging to transport the device, if possible.
- Clean the device before storing. Follow the cleaning instructions in chapter **8.1.1. Basic Cleaning Instructions** on page 33.
- Store the device in the original packaging, if possible.

## Disposal

### Correct disposal of this product



#### Waste Electrical and Electronic Equipment

This symbol on the product, its packaging or documents indicates that the product shall not be treated as household waste. Dispose of this product by handing it to the respective collection point for recycling of electrical and electronic equipment. This is to avoid environmental damage or personal injury due to uncontrolled waste disposal. For more detailed information about recycling of this product contact the local authorities or the authorized dealer.

## Approval



Check the respective product page on the website of Highlite International ([www.highlite.com](http://www.highlite.com)) for an available declaration of conformity.



©2021 Showtec