

SGM[®] **G-1 BEAM**
MOVING HEAD

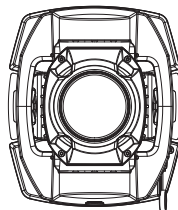

Dimensions

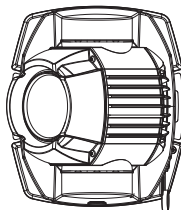
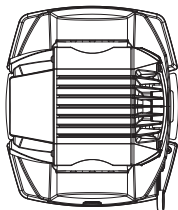
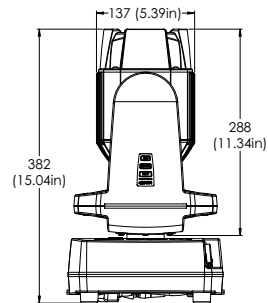
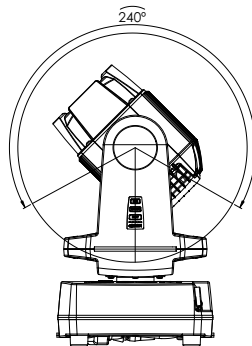
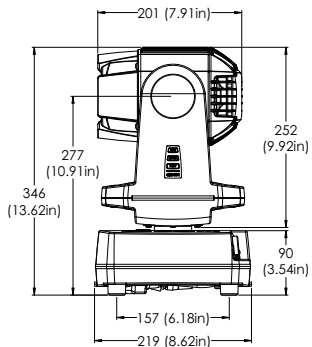
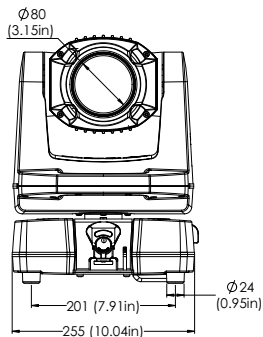

*Measurements in millimetres
and inches (in parentheses).
Drawing not to scale.*

G-1 BEAM USER MANUAL

© 2015 SGM®. Information subject to change without notice. SGM and all affiliated companies disclaim liability for any injury, damage, direct or indirect loss, consequential or economic loss or any other loss occasioned by the use of, inability to use or reliance on the information contained in this manual.

The SGM logo, the SGM name and all other trademarks in this document pertaining to services or products by SGM or its affiliates and subsidiaries are trademarks owned or licensed by SGM or its affiliates or subsidiaries.

The original edition of this document is in English. All other language editions are translations of the original edition.

This edition applies to firmware version **1.00** or later.

Rev. B

Contents

Dimensions	2
Safety information	8
<i>Preventing electric shock</i>	8
<i>Preventing burns and fire</i>	9
<i>Warning: LI-ION battery</i>	10
<i>Avoid personal injury</i>	11
Overview	12
Parts identification and terminology	13
Preparing for installation	14
<i>Unpacking</i>	14
<i>Location/application</i>	15
<i>Transportation</i>	15
Installation / Rigging	16
<i>Rigging process</i>	17
<i>Locating the front of the fixture</i>	17

Connecting AC power	18
AC power, battery and charging	19
<i>Battery charging and use</i>	19
G-1 Beam battery (option)	20
Connect/disconnect head and base	22
<i>Mounting the head on the base</i>	22
<i>Removing the head from the base</i>	22
Labels and serial numbers	23
<i>Labels</i>	23
<i>Serial numbers</i>	23
Configuring the device for DMX control	24
<i>About DMX</i>	24
<i>DMX start address</i>	24
<i>Setting the DMX address</i>	24
<i>Connecting to a DMX control device</i>	24

Display/Control button panel operations	25
<i>Using the control panel</i>	25
<i>Set/edit DMX address</i>	26
<i>Wireless log off</i>	27
<i>Wireless status</i>	27
<i>Error codes</i>	28
<i>Battery status</i>	28
<i>Run program</i>	29
<i>Pan / Tilt presets</i>	30
Gobo wheel	31
<i>Identification of the gobo wheel</i>	31
Color wheel	32
<i>Identification of the color wheel</i>	32
Service	33
<i>Cleaning</i>	33
<i>Support hotline</i>	33
<i>Upgrading the firmware</i>	34
DMX protocol	35
<i>Mode</i>	35
<i>DMX channels</i>	35
<i>Channel details</i>	36

Effects	52
Fixtures and accessories	53
<i>Included items</i>	53
<i>Ordering information</i>	53
APPROVALS AND CERTIFICATIONS	54
User's notes	55

Safety information



WARNING! Read the safety precautions in this section before unpacking, installing, powering or operating this product.

The G-1 Beam is intended for professional use only. It is not suitable for household use. **Impropre a l'usage domestique.**

Review the following safety precautions carefully before installing or operating the fixture. This product must be installed in accordance with the applicable installation code by a person familiar with the construction and operation of the product and the hazards involved. **Ce produit doit être installé selon le code d'installation pertinent, par une personne qui connaît bien le produit et son fonctionnement ainsi que les risques inhérent.**

Preventing electric shock



WARNING! Risk of electric shock.

- Always power off/unplug the fixture before removing covers or dismantling the product.
- Ensure that the mains power is off when wiring the fixture to the AC mains supply.
- Ensure that the fixture is electrically connected to earth (ground).
- Do not apply power if the fixture is in any way damaged.
- Do not immerse the fixture in water or liquid.

Preventing burns and fire



WARNING! *Take measures to prevent burns and fire.*

- Install in a location that prevents accidental contact with the fixture.
- Install only in a well-ventilated space.
- Install at least 0.3 m (12 in.) away from objects to be illuminated.
- Install only in accordance with applicable building codes.
- Do not paint, cover or modify the fixture.
- Keep all flammable materials away from the fixture.
- Allow the fixture to cool for 15 minutes after operation, before touching it.

CAUTION: *Exterior surface temperature after 5 min. operation = 42° C (108° F). Steady state = 62° C (144° F)*

Warning: LI-ION battery

Misusing the battery may cause the battery to get hot, rupture, or ignite and cause serious injury. Be sure to follow the safety rules listed below:

- Do not place the battery in fire or heat the battery.
- Do not install the battery backwards so that polarity is reversed.
- Do not connect the positive terminal and negative terminal of the battery to each other with any metal object (such as wire).
- Do not carry or store the batteries together with necklaces, hairpins or other metal objects.
- Do not pierce the battery with nails, strike the battery with a hammer, step on the battery, or otherwise subject it to strong impacts or shocks.
- Do not expose the battery to water or salt water, or allow the battery to get wet.
- Do not disassemble or modify the battery. The battery contains safety and protection devices which, if damaged, may cause the battery to generate heat, rupture or ignite.
- Do not place the battery on or near fires, stoves, or other high-temperature locations. Do not place the battery in direct sunlight. Doing so may cause the battery to generate heat, rupture, or ignite. Using the battery in this manner may also result in a loss of performance and a shortened life expectancy.
- Do not place the battery in microwave ovens, high-pressure containers, or on induction cookware.
- Immediately discontinue use of the battery if, while using, charging, or storing the battery, the battery emits an unusual smell, feels hot, changes color or shape, or appears abnormal in any other way.
- Only charge the battery mounted in the fixture with the built-in charger. Do not use a third party charger.
- Do not charge unattended.
- Only charge the battery if surrounding temperature is in the range +5 to +35°C (41° to 95°F). Charging the battery at temperatures outside of this range may cause the battery to become hot or break. Charging the battery outside of this temperature range may also harm the performance of the battery or reduce the battery's life expectancy.
- Do not replace the battery in the fixture with other types of rechargeable batteries.
- Do not replace the battery in the fixture with non-rechargeable batteries, such as dry-cell batteries etc.
- When the battery is worn out, insulate the terminals with adhesive tape or similar materials before disposal.
- Follow applicable laws and regulations for transport, shipping, and disposal of batteries. For details on recycling lithium, lithium-phosphate, and lithium-ion batteries, please contact a government recycling agency or your waste-disposal service.

Avoid personal injury



WARNING! Take measures to prevent personal injury.

- Do not look directly at the light source from close range.
- Take precautions to prevent injury when working at height.
- Ensure that the fixture is always securely fastened with suitable hardware.
- For elevated installations, secure the fixture with suitable safety cables, and always comply with relevant load dimensioning, safety standards and requirements.

Overview

The G-1 Beam is a lightweight moving head luminaire, weighing 8.9 kg/19.6 lbs. including batteries or 8.0 kg/17.6 lbs without batteries. It is IP-65-rated and can operate in temperatures from -10°C to 40°C in all kinds of weather.

The G-1 Beam provides built-in wireless DMX and preset-able stand-alone programs. The G-1 Beam also features a gobo wheel of 19 gobo, oscillation effects + 2 times open and a color wheel of 14 colors + open, adding further dimensions and dynamics to this compact moving head, which is expanded by attributes such as gobo shake function, split colors, macro effects and continuous clockwise and counter-clockwise pan rotation.

The G-1 Beam provides a staggering output of more than 60,000 lux at a 3-meter distance and a fixed color temperature at 6,500K of pure white light (can be altered to a warm white by utilizing the CTO filter on the color wheel). The fixture is equipped with a 2.8° fixed beam angle; however, it can deliver an aperture pseudo zoom adjustable down to 0.3°. Lamp life expectancy is 50,000 hours*.

The G-1 Beam comes in different varieties: with or without the base unit, the base unit comes with or without the battery option (3 batteries). Batteries can afterwards be inserted to base units that have been delivered without the battery option, in quantities of 1, 2 or 3, making positioning independent from any power source.

The combination of wireless DMX and the battery option, as well as the ability to mount the G-1 Beam without the base, make the G-1 Beam very versatile and able to serve a vast variety of creative purposes.

This manual covers installation, use and maintenance of the G-1 Beam.
All documentation is also available from the SGM website:

www.sgmlight.com

* At 70% of luminous output under the manufacturer's test conditions.

Parts identification and terminology

A: Power in

B: Bracket for base mounting

C: Push button panel

D: Yoke handles

E: Safety wire attachment point

F: Battery indicator

G: DMX in and out

H: Holes for omega bracket

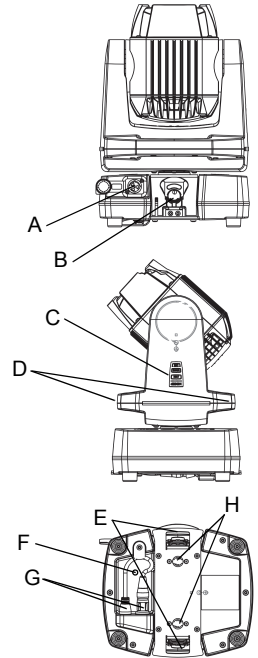

Preparing for installation

Unpacking

Unpack the fixture and inspect it to ensure that it has not been damaged in transport.

The G-1 Beam is shipped with:

- User manual
- One Neutrik TRUE1 power input connector, 2 m (78 in.)
- One Omega bracket with 1/4-turn fasteners
- Batteries (optional)
- Base incl. base bracket (optional)

G-1 Beam head

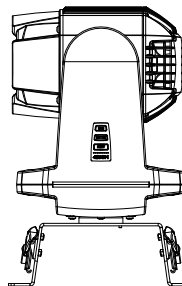

G-1 base bracket

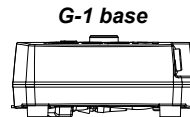

G-1 base

Location/application

The fixture is IP65-rated and designed for use in wet locations. This means that it is protected from:

- Dust; to the degree that dust cannot enter the fixture in sufficient quantities to interfere with its operation.
- Lower pressure jets of water from any direction.

When selecting a location for the fixture, ensure that:

- it is situated away from public thoroughfares and protected from contact with people.
- It is not immersed in water or exposed to high-pressure water jets.
- it has adequate ventilation.

Transportation

Always use the supplied packaging or suitable flight case for transportation and storage.

Never carry the fixture by connected cables or wires, use the handles.

Installation / Rigging



WARNING! Always secure elevated fixtures with a safety cable.

The G-1 Beam may be installed in any orientation, with or without base.

Always use an omega bracket to rig the fixture. Lock the bracket with the 1/4-turn fasteners.

The fasteners are locked only when turned fully clockwise.

Always fasten a safety wire between the load-bearing support structure and the attachment point on the fixture. The safety cable must be able to bear at least 10 times the weight of the fixture.

CAUTION:

- Always use a safety wire.
- Min. safety wire gauge = 4 mm.
- Max. safety wire length (free fall) = 30 cm (12 in.)
- Make sure the slack of the safety wire is at a minimum.
- Never use the carrying handles for secondary attachment.

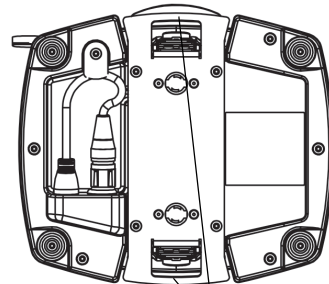
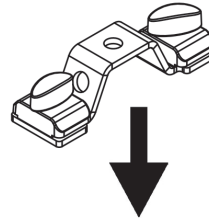

Safety wire attachment points

Rigging process

Start the rigging process by blocking the work area below, and make sure the work is performed from a stable platform.

- 1 Check that the clamp is undamaged and can bear at least 10 times the weight of the fixture. Check that the structure can bear at least 10 times the weight of all installed fixtures, clamps, cables etc.
- 2 Bolt the clamp securely to an omega bracket with a M12 / 1/2" bolt (min. grade 8.8) and lock nut.
- 3 Align the omega bracket with two 1/4-turns in the base. Insert the fasteners into the base and turn both levers a full 1/4-turn clockwise to lock.
- 4 Working from a stable platform, hang the fixture on a truss, or other structure. Tighten the clamp.
- 5 Install a safety wire that can bear at least 10 times the weight of the fixture. The attachment point is designed to fit a carbine.
- 6 Verify that there are no combustible materials or surfaces to be illuminated within 0.3 m (12 in.) of the fixture.
- 7 Check that there is no possibility of head or yoke colliding with other fixtures.

Locating the front of the fixture

The front of the fixture is the side opposite of the power input socket.

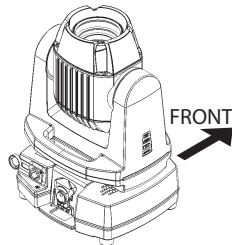

Connecting AC power

The G-1 Beam can operate on any 100-240V, 50/60 Hz mains power supply.



Connect the fixture to power using a cable with a Neutrik TRUE1 power connector (supplied with the fixture).

Connect both DMX in and DMX out cables in order to maintain the fixtures IP65 rating.

The G-1 Beam can also run on battery power (up to 12 hours, when three batteries are installed).

See "Ordering information" on page 53 for more details.

The fixture must be grounded/earthed and be able to be isolated from AC power. The AC power supply must incorporate a fuse or circuit breaker for fault protection.

<i>Wire</i>	<i>Color</i>	<i>Symbol</i>	<i>Conductor</i>
	Black	L	live
	White	N	neutral
	Green	⏏ or ⏚	ground (earth)

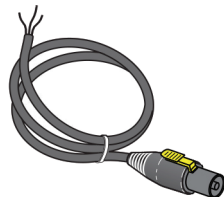

CAUTION: Do not connect the fixture to an electrical dimmer system, as doing so can damage it.

AC power, battery and charging

If the G-1 Beam is configured with batteries and connected to AC power by cable, the fixture will not turn off if the power is disconnected.

If the G-1 Beam runs on batteries when power is connected, the fixture will continue to run on AC power. When AC power is disconnected, the fixture will return to run on batteries.

Have the G-1 Beam turned off due to continuous resistance to the pan & tilt (forcing it away from position for a prolonged period), then the G-1 Beam can be turned back on by sending a full reset by DMX (only when connected to AC power). On batteries the G-1 Beam can be turned back on by pressing and holding any button on the control panel for 5 seconds.

Battery charging and use

The batteries are charging in the following scenarios, when connected to AC power:

- When the fixture is off.
- When the fixture is on but idle / not used.

The batteries do not charge while the fixture is in active use, e.g. when the light source is on, when pan/tilt is in use etc.

- Charging from total discharged to full voltage and 70% of full capacity, 8-12 hours.*
- Charging from total discharged to full voltage and 100% of full capacity, 12-16 hours.*

When using the G-1 Beam running on battery power the estimated use time is:

- Battery capacity non-stop use 5-7 hours.*
- Battery capacity typical use 10-12 hours.*

After 500 full cycles the expected battery capacity will be 85% of the initial capacity. (Full cycle = 0% to 100% to 0%).*
If the capacity levels charged to / discharged to are reduced, then the number of cycles are significantly higher.

* Under the manufacturer's test conditions.

G-1 Beam battery (option)

To install or replace the batteries (1, 2, or 3) in the G-1 Beam fixture, follow the procedure outlined below:

- 1 Disconnect the fixture from power (if applicable).
- 2 Remove the head from the base and place the base in a stable position before proceeding.
- 3 Remove the five screws (T25) under the base to release the top shell of the base.
See image on page 21.
- 4 If replacing batteries disconnect them from the PCB by removing the three connectors. See image on page 21.
If installing batteries to a base without batteries, skip this step.
- 5 Remove the four screws (two T25 and two T20). If necessary, remove wire clips and wires to access the screws.
See image on page 21.
- 6 Remove the bracket holding the batteries in place. If replacing battery/batteries subsequently take out the batteries.
- 7 Install or replace the battery or batteries and reverse the above procedure.
- 8 It is **very important** to ensure the G-1 Beam is vacuum tested once the G-1 Beam base unit has been fully re-assembled to make sure it complies with the IP65 requirements.
Use the SGM Vacuum test kit, or contact your local SGM dealer.

IMPORTANT: *If you install only one battery in the G-1 Beam fixture, it is important that you connect that battery to the number 1 connector on the PCB. If you install more than one battery, the connection order is irrelevant as long as the number 1 connector on the PCB is used by one of the batteries installed. If you do not follow this procedure, the G-1 Beam fixture will not function properly.*

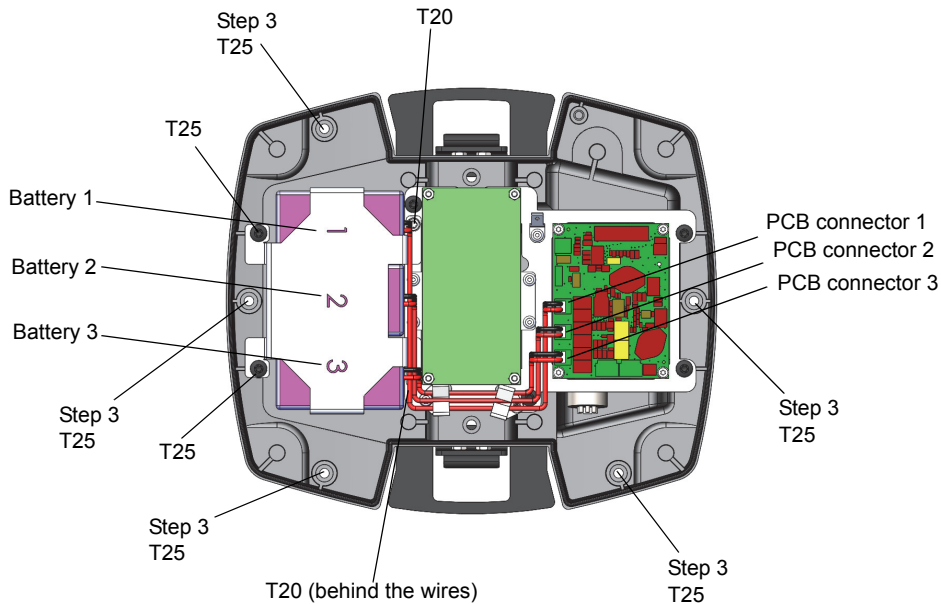

Connect/disconnect head and base

Mounting the head on the base

- 1 Make sure the arrow on the head bracket (DETAIL A) points towards the same direction as the arrow on the base (DETAIL B).
- 2 Make sure the two butterfly locks (DETAIL C) are in locked position so that they do not get jammed when mounting the head to the base.
- 3 Carefully position the head on the base, making sure that the arrow on the base unit (DETAIL B) slides into the arrow on the head bracket (DETAIL A). Additionally a slot on the head bracket slides over the guide knob on the base unit to steer the downwards movement.
- 3 After the head has been properly positioned on the base, use the butterfly locks (DETAIL C) to fasten the head securely to the base (DETAIL D).

Removing the head from the base

- 1 Loosen the two butterfly locks on the head bracket (DETAIL C) from the base (DETAIL D).
- 2 With a firm grip, gently pull the head away from the base in a straight upwards movement.

CAUTION: Be careful when connecting/disconnecting the head and the base in order to avoid damaging the connectors between the head and the base.

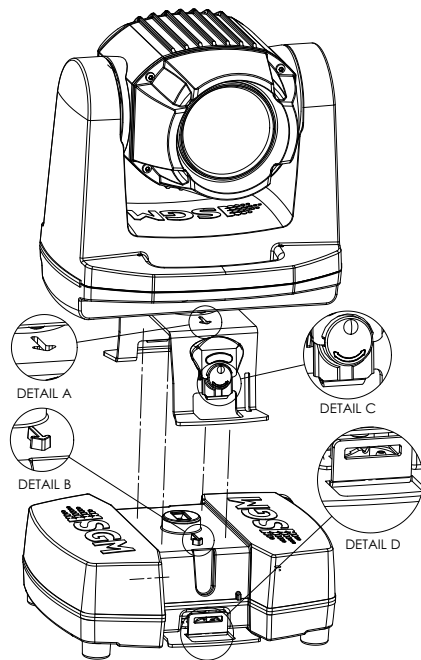

Labels and serial numbers

Labels

The G-1 Beam's labels are mounted on its head and base.

- The head unit's label is mounted on the bottom of the yoke.
- The base unit's label is mounted on the bottom of the base.

Serial numbers

The serial numbers are unique for both head and base units.

This means that the head and the base units have different serial numbers.

In case the head and base units have been delivered together, the base will have an additional label with the serial number of the head it came with. (See additional base label on the right).

Serial label:



Additional base label:



Configuring the device for DMX control

About DMX

The G-1 Beam can be controlled using signals sent by a DMX controller on a number of channels. (The G-1 Beam operates in one mode only, 12 channel mode)

DMX start address

The first channel used to receive data from a DMX control device is known as the DMX start address. Each G-1 Beam must have a DMX start address set. E.g., if a fixture has a DMX address of 12 and it is in 3-channel DMX mode, it uses channels 12, 13 and 14. The following device in the DMX chain could then be set to a DMX address of 15. If two or more DMX devices of the same type have the same DMX address, they will mimic each other's behaviour. Incorrect settings will result in unpredictable responses to the lighting controller.

Address sharing can be useful for diagnostic purposes and symmetrical control.

Setting the DMX address

The DMX address can be seen on the control panel.

- See “Set/edit DMX address” on page 26 for more information.
- See the “DMX protocol” on page 35 for specific DMX control values.

Connecting to a DMX control device

The G-1 Beam is controllable using a DMX control device and it can be connected using either a DMX cable or via the fixture's built-in CRMX wireless receiver system. If using a cabled DMX system, connect the DMX in cable (with male 5-pin XLR plug) and out cable (with female 5-pin XLR plug) to the DMX data link. Terminate the DMX out cable of the last fixture in the data link. For outdoor installations, use only IP-rated XLR connectors suitable for outdoor use.

Note: Remote Device Management (RDM) requires cabled DMX.

Display/Control button panel operations

The control panel can be used to configure individual fixture settings and check the fixture's wireless status and firmware version. When the fixture is powered on, it boots and resets, then displays the DMX start address.



Using the control panel

To turn on the G-1 Beam when running of batteries, press and hold any button for 5 sec.

To turn on the G-1 Beam when running of cabled power, press any button and the fixture powers on instantly.

Press any button to disable pan/tilt. (This times out after 10 sec.).

To turn off the G-1 Beam completely, hold 'ESC' until all LEDs are lit from left to right (1-9).

See the illustration below for further navigation instructions:

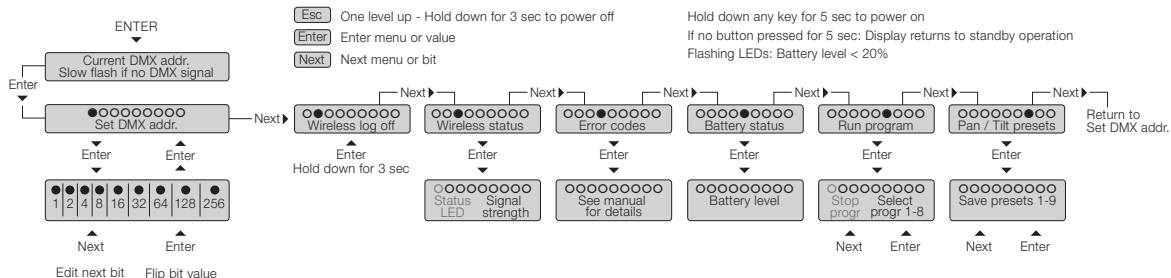

Set/edit DMX address

The DMX address is shown as a binary number (bit pattern) in the LED status bar on the control panel.

To edit the DMX address:

- 1 Press 'ENTER' on the control panel to enter the menu.
- 2 Press 'NEXT' until the first LED is lit.
- 3 Press 'ENTER' to enter the "Set DMX address" menu
- 4 The first bit is automatically selected (value 1).
- 5 Press 'ENTER' to change the status of the selected bit (on/off).
- 6 Press 'NEXT' to select the next bit.
- 7 Press 'ENTER' to change the status of the selected bit (on/off).

To exit the "Set DMX address" menu, press 'NEXT' after the ninth LED in the bit pattern. Pressing 'ESC' cancels any changes.

See the table below for an overview of the binary number system.

Binary representation (LED status bar on fixture)	1	2	3	4	5	6	7	8	9
Value	1	2	4	8	16	32	64	128	256

E.g., to set the fixture to channel 28 ($4 + 8 + 16 = 28$), select LED 3 (= value **4**), LED 4 (= value **8**), and LED 5 (= value **16**).

To set the fixture to channel 42, ($2 + 8 + 32 = 42$), select LED 2 (= value **2**), LED 4 (=value **8**), and LED 6 (=value **32**).

See "Using the control panel" on page 25 for instructions on using the control panel.

Wireless log off

To log off the connected wireless transmitter, navigate to the second menu point.

- 1 Press 'ENTER' on the control panel to enter the menu.
- 2 Press 'NEXT' until the second LED is lit.
- 3 Press and hold 'ENTER' for 3 seconds to log off the connected wireless transmitter.
- 4 Exit the 'Wireless log off' menu by pressing 'ESC'.

Wireless status

To view the wireless status, navigate to the third menu point.

- Press 'ENTER' on the control panel to enter the menu.
- Press 'NEXT' until the third LED is lit.
- Press 'ENTER' to view the wireless status.
- Exit the 'Wireless status' menu by pressing 'ESC'.

The first LED in the LED status bar on the control panel displays the current wireless status. See detailed explanation to the right.

LED 2 to 9 displays the signal strength.

- If the LEDs are sequencing inwards towards the centre from left and right, the wireless receiver is in bootloader and the firmware has to be reloaded.
- If the LEDs 1 to 4 and 6 to 9 are blinking left, right, left etc. either the CRMX chip is not fitted or not working.
- If the LEDs are scrolling from left to right to left etc. the G-1 Beam is not linked to a transmitter.



OFF = Not linked to transmitter



FLASHING (FAST) = Active radio link, but no DMX data

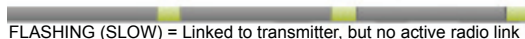

FLASHING (SLOW) = Linked to transmitter, but no active radio link



ON = Active radio link and DMX data

Error codes

To display stored error codes, navigate to the fourth menu point.

- 1 Press 'ENTER' on the control panel to enter the menu.
- 2 Press 'NEXT' until the fourth LED is lit.
- 3 Press 'ENTER' to view any stored error codes.

If any error codes are stored, the LED in the LED status bar on the control panel representing the error will be lit.

See table to the right for error code index.

For wireless DMX related error codes see "Wireless status" on page 27.

Error codes	
1	Pan
2	Tilt
3	Gobo
4	Color
5	Focus
6	Light Source
7	Main Board
8	Head Board
9	Other

Battery status

To display battery level, navigate to the fifth menu point.

- 1 Press 'ENTER' on the control panel to enter the menu.
- 2 Press 'NEXT' until the fifth LED is lit.
- 3 Press 'ENTER' to view battery level.

The nine LEDs in the LED status bar on the control panel represent 0 to 100%.

Run Program

To run the built-in programs, navigate to the sixth menu point.

- 1 Press 'ENTER' on the control panel to enter the menu.
- 2 Press 'NEXT' until the sixth LED is lit.
- 3 Press 'ENTER' to enter the "Run program" menu.
- 4 Press 'NEXT' until the desired program is indicated by the LED in the LED status bar on the control panel.
- 5 Press 'ENTER' to run the program.

Below is an overview showing details about the available internal programs:

LED Number	Program	Color	Gobo	Movement	Position reference
1	STOP ACTIVE PROGRAM				
2	1	White	Open	Small circle slow	Stored position 1
3	2	White	Open	Large circle slow	Stored position 1
4	3	White	Open	Pan continuous and til swing	N/A
5	4	Scroll	Scroll	Large circle slow	Stored position 1
6	5	White	Open	Pan continuous	Stored position 1 (Tilt)
7	6	White	Open	Sequential stored positions fade	All
8	7	White	Open	Static stored position 1	Stored position 1
9	8	N/A	N/A	N/A	N/A

Note: To STOP any internal program press 'ENTER' when the first LED is lit.

Pan / Tilt presets

To store internal Pan / Tilt presets, navigate to the seventh menu point.

- 1 Press 'ENTER' on the control panel to enter the menu.
- 2 Press 'NEXT' until the seventh LED is lit.
- 3 Press 'ENTER' to enter the "Pan / Tilt presets" menu.
- 4 Press 'NEXT' to select which preset to store / overwrite.
- 5 Point the head to the desired position. (Pan / Tilt motors are off at this point).
- 6 Press 'ENTER' to store / overwrite the preset.

Up to nine positions can be stored, each represented by a LED in the LED status bar on the control panel.

The internal Pan / Tilt presets can be recalled and stored by DMX by utilizing the 'Pan mode channel'. See "DMX protocol" on page 35.

These presets are also used as position references for the internal programs. See "Run Program" on page 29.

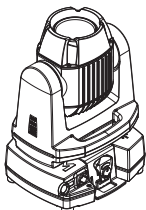

Choose preset to store.
Press 'ENTER' to confirm.

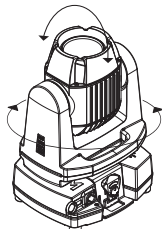

Adjust the position by hand.

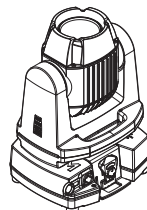

Press 'ENTER' to confirm position.

Gobo wheel

Identification of gobo wheel

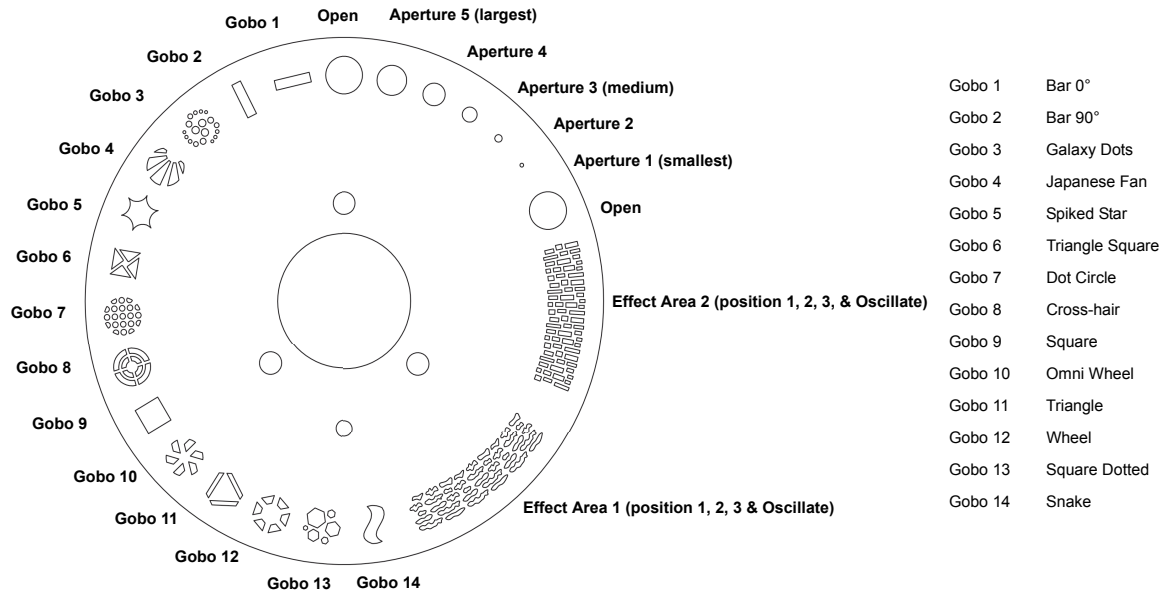

Color wheel

Identification of color wheel

Color 1	Congo
Color 2	Red
Color 3	Green
Color 4	Blue
Color 5	Orange
Color 6	Light Green
Color 7	Pink
Color 8	Light Blue / CTB
Color 9	Lavender / Purple
Color 10	Fluorescent Green
Color 11	Magenta
Color 12	Cyan
Color 13	Yellow
Color 14	CTO (CTC ≈3000K)

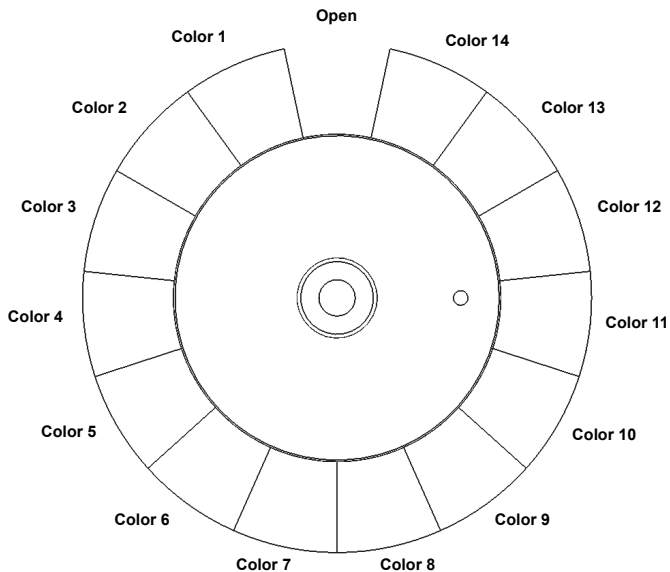

Service

There are no user-serviceable components in the fixture. Do not open the G-1 Beam head unit, as doing so is likely to damage its ingress protection (IP) rating. Consult your SGM dealer if the fixture operates abnormally, is defective or otherwise in need of service or repair.

Cleaning

To obtain optimal performance, regular cleaning is essential. Cleaning schedules will vary greatly depending on the operating environment, and the installation should therefore be checked at frequent intervals within the first few weeks of operation to see whether cleaning is necessary. This procedure will allow an assessment of cleaning requirements in the particular installation environment. If in doubt, consult your SGM dealer for a suitable maintenance schedule.

Clean the G-1 Beam using a soft cloth dampened with a solution of water and a mild detergent. Do not use any product that contains solvents, abrasives or caustic agents for cleaning, as they can cause damage to both hardware, cables, connectors, plastic or painted surfaces.

Support hotline

SGM offers a 24/7 technical support hotline.

Worldwide: +45 3840 3840

US: +1 877 225-3882

Upgrading the firmware

The firmware installed on the fixture can be identified when powering on. The binary bit pattern will flash corresponding to the installed firmware version number. E.g., if the fixture's current firmware version is 1.30, the binary bit pattern in the control panel will flash as shown in the graphic below:

First 1:

1	2	4	8	16	32	64	128	256
●	○	○	○	○	○	○	○	○

Then 3 (1+2):

1	2	4	8	16	32	64	128	256
●	●	○	○	○	○	○	○	○

We recommend that fixture's firmware is always up-to-date.

Visit **www.sgmlight.com** to download the latest firmware.

To perform firmware updates, use a Windows-based personal computer and a SGM USB 5-Pin-XLR upload cable (available from your SGM dealer).

DMX protocol

Mode

The G-1 Beam operates in one mode only, 12 channel mode.

DMX Channels

1	Shutter
2	Intensity
3	Macro effects
4	Pan MSB
5	Pan LSB
6	Tilt MSB
7	Tilt LSB
8	Pan mode
9	Gobo
10	Color
11	Focus
12	Control channel

See detailed channel chart on the following pages.

Channel	Name	DMX Value		DMX Percentage		Description	Info	Default DMX Value	Fader Type
1	Shutter	0	7	0,0%	2,7%	Closed		10 (3,9%)	Snap
		8	12	3,1%	4,7%	Open	(See note 1)		
		16	17	5,1%	6,7%	Open, Blackout on color/gobo change	Slow > Fast		
		18	88	7,1%	34,5%	Strobe	Slow > Fast		
		89	108	34,9%	42,4%	Pulse - Open	Slow > Fast		
		109	128	42,7%	50,2%	Pulse - Close	Slow > Fast		
		129	178	50,6%	69,8%	Strobe - Random			
		179	198	70,2%	77,6%	Random Lighting	Fast -> Slow		
		199	208	78,0%	81,6%	Random Double Strobe	Fast -> Slow		
		209	218	82,0%	85,5%	Random Triple Strobe	Fast -> Slow		
		219	228	85,9%	89,4%	White Noise	Fast -> Slow		
		229	255	89,8%	100,0%	Open			
2	Intensity	0	65535	0,0%	100,0%	No light -> Maximum light		0 (0%)	Fade

Channel	Name	DMX Value	DMX Percentage	Description	Info	Default DMX Value	Fader Type	
3	Macro Effects	0	4	0,0%	1,6%	Disabled (See note 1)	0 (0%)	Fade
		5	9	2,0%	3,5%	Macro 1 (Pseudo Iris Open)		
		10	14	3,9%	5,5%	Macro 2 (Pseudo Iris Open/Close)		
		15	19	5,9%	7,5%	Macro 3 (Pseudo Iris Close)		
		20	24	7,8%	9,4%	Macro 4 (Pseudo Iris Random)		
		25	29	9,8%	11,4%	Macro 5 (Open <-> Smallest Aperture Switch)		
		30	34	11,8%	13,3%	Macro 6 (Cross)		
		35	39	13,7%	15,3%	Macro 7 (Cross, Red/Green)		
		40	44	15,7%	17,3%	Macro 8 (Square <-> Cross-hair)		
		45	49	17,6%	19,2%	Macro 9 (Random Gobo)		
		50	54	19,6%	21,2%	Macro 10 (Gobo switch only)		
		55	59	21,6%	23,1%	Macro 11 (Omni wheel <-> Wheel)		
		60	64	23,5%	25,1%	Macro 12 (Triangle Square <-> Square)		

Channel	Name	DMX Value	DMX Percentage	Description	Info	Default DMX Value	Fader Type	
3	Macro Effects	65	69	25,5%	27,1%	Macro 13 (Dot Circle <-> Cross-hair)	0 (0%)	Fade
		70	74	27,5%	29,0%	Macro 14 (Random position Effect Area 1)		
		75	79	29,4%	31,0%	Macro 15 (Random position Effect Area 2)		
		80	84	31,4%	32,9%	Macro 16 (Random Color)		
		85	89	33,3%	34,9%	Macro 17 (Random Color and Gobo)		
		90	94	35,3%	36,9%	Macro 18 N/A		
		95	99	37,3%	38,8%	Macro 19 N/A		
		100	104	39,2%	40,8%	Macro 20 N/A		
		105	109	41,2%	42,7%	Macro 21 N/A		
		110	114	43,1%	44,7%	Macro 22 N/A		
		115	119	45,1%	46,7%	Macro 23 N/A		
		120	124	47,1%	48,6%	Macro 24 N/A		
		125	129	49,0%	50,6%	Macro 25 N/A		

Channel	Name	DMX Value	DMX Percentage	Description	Info	Default DMX Value	Fader Type	
3	Macro Effects	130	134	51,0%	52,5%	Macro 26 N/A	0 (0%)	Fade
		135	139	52,9%	54,5%	Macro 27 N/A		
		140	144	54,9%	56,5%	Macro 28 N/A		
		145	149	56,9%	58,4%	Macro 29 N/A		
		150	154	58,8%	60,4%	Macro 30 (Open <-> To Current Gobo)		
		155	159	60,8%	62,4%	Macro 31 (Aperture 1 (Smallest) <-> To Current Gobo)		
		160	164	62,7%	64,3%	Macro 32 (Aperture 2 <-> To Current Gobo)		
		165	169	64,7%	66,3%	Macro 33 (Aperture 3 (Medium) <-> To Current Gobo)		
		170	174	66,7%	68,2%	Macro 34 (Aperture 4 <-> To Current Gobo)		
		175	179	68,6%	70,2%	Macro 35 (Aperture 5 (Largest) <-> To Current Gobo)		
		180	184	70,6%	72,2%	Macro 36 (Open <-> To Current Gobo)		
		185	189	72,5%	74,1%	Macro 37 (Gobo 1 (Bar 0°) <-> To Current Gobo)		
		190	194	74,5%	76,1%	Macro 38 (Gobo 2 (Bar 90°) <-> To Current Gobo)		

Channel	Name	DMX Value	DMX Percentage	Description	Info	Default DMX Value	Fader Type	
3	Macro Effects	195	199	76,5%	78,0%	Macro 39 (Gobo 3 (Galaxy Dots) <-> To Current Gobo)	0 (0%)	Fade
		200	204	78,4%	80,0%	Macro 40 (Gobo 4 (Japanese Fan) <-> To Current Gobo)		
		205	209	80,4%	82,0%	Macro 41 (Gobo 5 (Spiked Star) <-> To Current Gobo)		
		210	214	82,4%	83,9%	Macro 42 (Gobo 6 (Triangle Square) <-> To Current Gobo)		
		215	219	84,3%	85,9%	Macro 43 (Omni wheel <-> Wheel)		
		220	224	86,3%	87,8%	Macro 44 (Gobo 8 (Cross-hair) <-> To Current Gobo)		
		225	229	88,2%	89,8%	Macro 45 (Gobo 9 (Square) <-> To Current Gobo)		
		230	234	90,2%	91,8%	Macro 46 (Gobo 10 (Omni Wheel) <-> To Current Gobo)		
		235	239	92,2%	93,7%	Macro 47 (Gobo 11 (Triangle) <-> To Current Gobo)		
		240	244	94,1%	95,7%	Macro 48 (Gobo 12 (Wheel) <-> To Current Gobo)		
		245	249	96,1%	97,6%	Macro 49 (Gobo 13 (Square dotted) <-> To Current Gobo)		
		250	254	98,0%	99,6%	Macro 50 (Gobo 14 (Snake) <-> To Current Gobo)		
		255	255	100,0%	100,0%	Disabled		

Channel	Name	DMX Value	DMX Percentage	Description	Info	Default DMX Value	Fader Type		
4 5	Pan	Depending On Pan Mode							
		0	65535	0,0%	100,0%	-270° to 270° / 540°	540° Mode	32767 (50%)	Fade
		0	65535	0,0%	100,0%	-180° to 180° / 360°	360° Mode		
		0	65535	0,0%	100,0%	-180° to 180° / 360° (Shortest Path)	360° Mode		
		Pan Mode Continuous Rotation							
		0	32766	0,0%	49,9%	CCW - Counter Clockwise	Fast -> Slow	32767 (50%)	Fade
		32767	32767	50,0%	50,0%	Stopped	Stopped		
		32768	65535	50,1%	50,1%	CW - Clockwise	Slow -> Fast		
6 7	Tilt	0	65535	0,0%	100,0%	-120° to 120°	32767 (50%)	Fade	
8	Pan Mode	0	7	0,0%	2,7%	540° Mode	Mode for Pan	0 (0%)	Snap
		8	15	3,1%	5,9%	360° Mode			
		16	23	6,3%	9,0%	360° Shortest Path Mode			

Channel	Name	DMX Value	DMX Percentage	Description	Info	Default DMX Value	Fader Type		
8	Pan Mode	24	31	9,4%	12,2%	Continuous Rotation Mode	Mode for Pan	0 (0%)	Snap
		32	143	9,4%	12,2%	Reserved			
		144	151	56,5%	59,2%	Store Pan/Tilt Pos 1	See note 2	0 (0%)	Snap
		152	159	59,6%	62,4%	Store Pan/Tilt Pos 2			
		160	167	62,7%	65,5%	Store Pan/Tilt Pos 3			
		168	175	65,9%	68,6%	Store Pan/Tilt Pos 4			
		176	183	69,0%	71,8%	Store Pan/Tilt Pos 5			
		184	191	72,2%	74,9%	Store Pan/Tilt Pos 6			
		192	199	75,3%	78,0%	Store Pan/Tilt Pos 7			
		200	207	78,4%	81,2%	Store Pan/Tilt Pos 8			
		208	215	81,6%	84,3%	Store Pan/Tilt Pos 9			
		216	223	84,7%	87,5%	Sequential Stored Positions Fade			
		224	231	87,8%	90,6%	Sequential Stored Positions Snap	Slow -> Fast		

Channel	Name	DMX Value		DMX Percentage		Description	Info	Default DMX Value	Fader Type
8	Pan Mode	232	239	91,0%	93,7%	Random Stored Positions Fade	Slow -> Fast	0 (0%)	Snap
		240	247	94,1%	96,9%	Random Stored Positions Snap	Slow -> Fast		
		248	255	97,3%	100,0%	540° Mode	Mode for Pan		
9	Gobo	0	4	0,0%	1,6%	Open		0 (0%)	Fade
		5	8	2,0%	3,1%	Aperture 1 (Smallest)			
		9	12	3,5%	4,7%	Aperture 2			
		13	16	5,1%	6,3%	Aperture 3 (Medium)			
		17	20	6,7%	7,8%	Aperture 4			
		21	24	8,2%	9,4%	Aperture 5 (Largest)			
		25	28	9,8%	11,0%	Open			
		29	32	11,4	12,5%	Gobo 1 (Bar 0°)			
		33	36	12,9%	14,1%	Gobo 2 (Bar 90°)			
		37	40	14,5%	15,7%	Gobo 3 (Galaxy Dots)			

Channel	Name	DMX Value		DMX Percentage		Description	Info	Default DMX Value	Fader Type
9	Gobo	41	44	16,1%	17,3%	Gobo 4 (Japanese Fan)		0 (0%)	Fade
		45	48	17,6%	18,8%	Gobo 5 (Spiked Star)			
		49	52	19,2%	20,4%	Gobo 6 (Triangle Square)			
		53	56	20,8%	22,0%	Gobo 7 (Dot Circle)			
		57	60	22,4%	23,5%	Gobo 8 (Cross-hair)			
		61	64	23,9%	25,1%	Gobo 9 (Square)			
		65	68	25,5%	26,7%	Gobo 10 (Omni Wheel)			
		69	72	27,1%	28,2%	Gobo 11 (Triangle)			
		73	76	28,6%	29,8%	Gobo 12 (Wheel)			
		77	80	30,2%	31,4%	Gobo 13 (Square dotted)			
		81	84	31,8%	32,9%	Gobo 14 (Snake)			
		85	88	33,3%	34,5%	Open (Shake)	Slow -> Fast		
		89	92	34,9%	36,1%	Aperture 1 (Smallest) Shake	Slow -> Fast		

Channel	Name	DMX Value	DMX Percentage	Description	Info	Default DMX Value	Fader Type		
9	Gobo	93	96	36,5%	37,6%	Aperture 2 Shake	Slow -> Fast	0 (0%)	Fade
		97	100	38,0%	39,2%	Aperture 3 (Medium) Shake	Slow -> Fast		
		101	104	39,6%	40,8%	Aperture 4 Shake	Slow -> Fast		
		105	108	41,2%	42,4%	Aperture 5 (Largest) Shake	Slow -> Fast		
		109	112	42,7%	43,9%	Open Shake	Slow -> Fast		
		113	116	44,3%	45,5%	Gobo 1 (Bar 0°) Shake	Slow -> Fast		
		117	120	45,9%	47,1%	Gobo 2 (Bar 90°) Shake	Slow -> Fast		
		121	124	47,5%	48,6%	Gobo 3 (Galaxy Dots) Shake	Slow -> Fast		
		125	128	49,0%	50,2%	Gobo 4 (Japanese Fan) Shake	Slow -> Fast		
		129	132	50,6%	51,8%	Gobo 5 (Spiked Star) Shake	Slow -> Fast		
		133	136	52,2%	53,3%	Gobo 6 (Triangle Square) Shake	Slow -> Fast		
		137	140	53,7%	54,9%	Gobo 7 (Dot Circle) Shake	Slow -> Fast		
		141	144	55,3%	56,5%	Gobo 8 (Cross-hair) Shake	Slow -> Fast		

Channel	Name	DMX Value		DMX Percentage		Description	Info	Default DMX Value	Fader Type
9	Gobo	145	148	56,9%	58,0%	Gobo 9 (Square) Shake	Slow -> Fast	0 (0%)	Fade
		149	152	58,4%	59,6%	Gobo 10 (Omni Wheel) Shake	Slow -> Fast		
		153	156	60,0%	61,2%	Gobo 11 (Triangle) Shake	Slow -> Fast		
		157	160	61,6%	62,7%	Gobo 12 (Wheel) Shake	Slow -> Fast		
		161	164	63,1%	64,3%	Gobo 13 (Square dotted) Shake	Slow -> Fast		
		165	168	64,7%	65,9%	Gobo 14 (Snake) Shake	Slow -> Fast		
		169	180	66,3%	70,6%	Effect Area 1 - Stepless Fade Through			
		181	192	71,0%	75,3%	Effect Area 2 - Stepless Fade Through			
		193	202	75,7%	79,2%	Effect Area 1 - Oscillate	Fast -> Stop		
		203	212	79,6%	83,1%	Effect Area 2 - Oscillate	Fast -> Stop		
		213	233	83,5%	91,4%	Continuous CCW Gobo Wheel Spin	Fast -> Slow		
		234	255	91,8%	100,0%	Continuous CW Gobo Wheel Spin	Slow -> Fast		

Channel	Name	DMX Value	DMX Percentage	Description	Info	Default DMX Value	Fader Type		
10	Color	Full Color Positions						0 (0%)	Fade
		0	4	0,0%	1,6%	Open			
		5	9	2,0%	3,5%	Color 1 (Congo)			
		10	14	3,9%	5,5%	Color 2 (Red)			
		15	19	5,9%	7,5%	Color 3 (Green)			
		20	24	7,8%	9,4%	Color 4 (Blue)			
		25	29	9,8%	11,4%	Color 5 (Orange)			
		30	34	11,8%	13,3%	Color 6 (Light Green)			
		35	39	13,7%	15,3%	Color 7 (Pink)			
		40	44	15,7%	17,3%	Color 8 (Light Blue / CTB)			
		45	49	17,6%	19,2%	Color 9 (Lavender / Purple)			
		50	54	19,6%	21,2%	Color 10 (Fluorescent Green)			
55	59	21,6%	23,1%	Color 11 (Magenta)					

Channel	Name	DMX Value	DMX Percentage	Description	Info	Default DMX Value	Fader Type		
10	Color	60	64	23,5% 25,1%	Color 12 (Cyan)		0 (0%)	Fade	
		65	69	25,5% 27,1%	Color 13 (Yellow)				
		70	74	27,5% 29,0%	Color 14 (CTO)				
		Stepless Color Positions							
		75	79	29,4% 31,0%	Open	Max - > ½	0 (0%)	Fade	
		80		31,4%	½ Split Open / Color 1				
		81	89	31,8% 34,9%	Color 1 (Congo)	½ -> Max -> ½			
		90		35,3%	½ Split Color 1 / Color 2				
		91	99	35,7% 38,8%	Color 2 (Red)	½ -> Max -> ½			
		100		39,2%	½ Split Color 2 / Color 3				
		101	109	39,6% 42,7%	Color 3 (Green)	½ -> Max -> ½			
110		43,1%	½ Split Color 3 / Color 4						
111	119	43,5% 46,7%	Color 4 (Blue)	½ -> Max -> ½					

Channel	Name	DMX Value	DMX Percentage	Description	Info	Default DMX Value	Fader Type	
10	Color	120	47,1%	½ Split Color 4 / Color 5		0 (0%)	Fade	
		121	129	47,5% 50,6%	Color 5 (Orange)			½ -> Max -> ½
		130	51,0%	½ Split Color 5 / Color 6				
		131	139	51,4% 54,5%	Color 6 (Light Green)			½ -> Max -> ½
		140	54,9%	½ Split Color 6 / Color 7				
		141	149	55,3% 58,4%	Color 7 (Pink)			½ -> Max -> ½
		150	58,8%	½ Split Color 7 / Color 8				
		151	159	59,2% 62,4%	Color 8 (Light Blue / CTB)			½ -> Max -> ½
		160	62,7%	½ Split Color 8 / Color 9				
		161	169	63,1% 66,3%	Color 9 (Lavender / Purple)			½ -> Max -> ½
		170	66,7%	½ Split Color 9 / Color 10				
		171	179	67,1% 70,2%	Color 10 (Fluorescent Green)			½ -> Max -> ½
		180	70,6%	½ Split Color 10 / Color 11				

Channel	Name	DMX Value	DMX Percentage	Description	Info	Default DMX Value	Fader Type	
10	Color	181	189	71,0% 74,1%	Color 11 (Magenta)	½ -> Max -> ½	0 (0%)	Fade
		190		74,5%	½ Split Color 11 / Color 12			
		191	199	74,9% 78,0%	Color 12 (Cyan)	½ -> Max -> ½		
		200		78,4%	½ Split Color 12 / Color 13			
		201	209	78,8% 82,0%	Color 13 (Yellow)	½ -> Max -> ½		
		210		82,4%	½ Split Color 13 / Color 14			
		211	219	82,7% 85,9%	Color 14 (CTO)	½ -> Max -> ½		
		220		86,3%	½ Split Color 14 / Open			
		221	225	86,7% 88,2%	Open	½ -> Max		
		226	238	88,6% 93,3%	Continual CCW Gobo Wheel Spin	Fast -> Slow		
		239	241	93,7% 94,5%	Stopped	Stopped		
		242	255	94,9% 100,0%	Continual CW Gobo Wheel Spin	Slow -> Fast		

Channel	Name	DMX Value		DMX Percentage		Description	Info	Default DMX Value	Fader Type
11	Focus	0	255	0,0%	100,0%	Near -> Far	Near > Far	127 (50%)	Fade
12	Control Channel	0	4	0,0%	1,6%	No Function		0 (0%)	Snap
		5	9	2,0%	3,5%	Full Reset			
		10	14	3,9%	5,5%	Pan Reset			
		15	19	5,9%	7,5%	Tilt Reset			
		20	24	7,8%	9,4%	Gobo Reset			
		25	29	9,8%	11,4%	Color Reset			
		30	34	11,8%	13,3%	Focus Reset			
		35	255	13,7%	100,0%	Reserved			

Note 1: Set the shutter channel to “blackout on gobo/color change” when using the built-in macro effects to obtain additional blackouts during effect transitions.

Note 2: When storing internal position pre-sets by DMX, hold the value on the pan-mode channel for 3 sec.

Effects

Gobo wheel

The gobo wheel consist of 19 gobos + oscillation effect + 2 x open positions to control the shape of emitted light.

Color wheel

The color wheel consist of 14 colors + open position to control the color of emitted light. In addition, the color wheel is optimized for split colors and color transitions.

High-precision pan and tilt

Continuous bi-directional quick rotation in pan and 240° in tilt.

Ultra high-speed strobe effect

The ultra high-speed strobe effect (1-50 Hz) introduces the possibility to strobe up to 50 times per second. Random strobe and pulse effects can be generated with variable speed.

Beam angle and aperture zoom

The G-1 Beam is equipped with a fixed 2.8° beam angle and an aperture pseudo zoom adjustable down to 0.3°.

Fixtures and accessories

Included items

User manual

One omega bracket with 1/4-turn fasteners

2 m power cable with Neutrik TRUE1 power connector

Ordering information

G-1 Beam in cardboard box (excl. batteries).....	Order no: 80100101
G-1 Beam in cardboard box (incl. 3 pcs batteries)	Order no: 80100103
Battery for G-1 (1 pcs).....	Order no: 80100108
Flight case for 4 pcs. G-1 Beam.....	Order no: 82051004
SGM USB uploader cable.....	Order no: 83062011
2 m power cable with Neutrik TRUE1 power connector	Order no: 07860040
Omega bracket.....	Order no: 83060602
LumenRadio CRMX transmitter (DMX only)	Order no: 80070229

APPROVALS AND CERTIFICATIONS

Conforms to 2004/108/EC: EMC Directive
Conforms to 2006/95/EC: Low Voltage Directive
Conforms to 2011/65/EU: RoHS2 Directive



The information in this document is subject to change without notice

User's notes



Distributor:



Phone: 407-857-8770

Fax: 407-857-8771

Email: sales@techni-lux.com

SGM A/S · Sommervej 23 · 8210 Aarhus V · Denmark
Tel +45 70 20 74 00 · info@sgmlight.com · www.sgmlight.com