

Carbon black finish

Satin silver finish

Snow white finish

Part Number	Description
GR211	Gantom R4 Recessed Spot - Dynamic White - Pro Cable Connector
GR212	Gantom R4 Recessed Spot - RGBW - Pro Cable Connector

Date
Project
Fixture
Comments

## Description

The R4 is a low-profile DMX controllable downlight with the same optics as the Gantom DMX V2 Spotlight. Field swappable diffusers give the user a wide range of beam control options. The R4 is available in RGBW or dynamic white output. The fixture includes three interchangeable trim options: black, white, and silver. Custom color trims can also be specially manufactured. Hex louver accessory included. **For our Dynamic White fixture, we have achieved a Preference and Fidelity Priority of P1/F2 across most of the fixture's CCT range. We have summarized the results below.** We humbly invite you to examine our full TM-30 report.

## Features

- ▶ Low-profile (60mm / 2.4" clearance)
- ▶ 4.8W RGBW or dynamic white LED
- ▶ Constant output algorithm for all colors
- ▶ Spring-clip installation
- ▶ Field swappable beam control diffusers included
- ▶ Black, white, and silver trims are included
- ▶ Insulated Contact (IC) rated
- ▶ Class 2, low-voltage 12-24VDC input (DO NOT HOT PLUG)
- ▶ DMX dimming
- ▶ Pro Cable connector (integrated power + data)
- ▶ 35mm hex louver accessory included

## TM-30-20

Specification Criteria for  
Gantom R4 Dynamic White Fixtures

CCT	Preference Fidelity Priority	R <sub>f</sub>	R <sub>g</sub>	R <sub>cs,h1</sub>	R <sub>f,h1</sub>	R <sub>a</sub> (CRI)
2650K	<b>P2/F2</b>	91	97	-2%	93	95
4200K	<b>P1/F2</b>	91	100	+1%	93	92
6200K	<b>P1/F2</b>	90	99	+1%	92	93

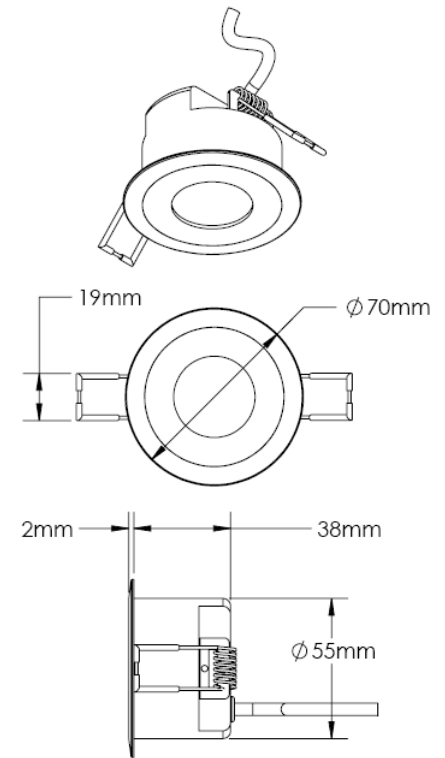

Recommend 58-64mm Diameter Mounting Hole (2.5 inch hole)

60mm clearance (2.25 inch clearance)

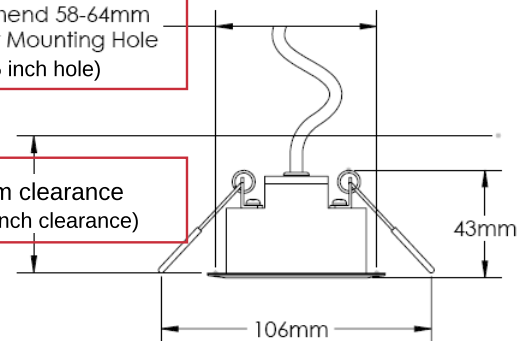

Distributor:



Phone: 407-857-8770

Fax: 407-857-8771

Email: sales@techni-lux.com

www.techni-lux.com

### Technical Specifications

#### Source

LED model	Cree MC-E (RGBW), Cree XB-D (Dynamic White)
-----------	--

#### LED Color

RGBW	Red 625nm, Green 530nm, Blue 460nm, White 6500K
Dynamic White	2650K (95 CRI) / 6200K (93 CRI)

#### Electrical

Voltage range	12-24VDC <b>DO NOT HOT PLUG</b>
Wattage	4.8W max
Dimming Compatability	DMX
Connector	Gantom Pro Cable Connector

#### Physical

Materials	Machined aluminum
Bezel color options	black, white, silver
IP rating	IP60 - indoor only
Weight	195 grams (6.9 oz)

#### Optical

	Beam / Field Angle	1m Illuminance	2m Illuminance	3m Illuminance
RGBW Beam / Field Angle Bare optics	16° / 32°	940 lx (87 fc)	260 lx (24 fc)	112 lx (10 fc)
RGBW Beam / Field Angle Narrow diffuser - 1 notch - (C-HE10)	18° / 36°	771 lx (72 fc)	218 lx (20 fc)	98 lx (9 fc)
RGBW Beam / Field Angle Medium diffuser - 2 notch - (C-HE30)	30° / 58°	330 lx (31 fc)	99 lx (9 fc)	44 lx (4 fc)
RGBW Beam / Field Angle Wide diffuser - 3 notch - (C-HE80)	55° / 98°	100 lx (9 fc)	28 lx (3 fc)	13 lx (1 fc)
RGBW Beam / Field Angle Assymmetric diffuser - U notch	16° / 46° short axis 39° / 67° long axis	230 lx (21 fc)	66 lx (6 fc)	30 lx (3 fc)
DW Beam / Field Angle Bare optics	23° / 44°	1400 lx (130 fc)	360 lx (33 fc)	160 lx (15 fc)
DW Beam / Field Angle Narrow diffuser (C-HE10)	24° / 46°	900 lx (84 fc)	263 lx (24 fc)	115 lx (11 fc)
DW Beam / Field Angle Medium diffuser (C-HE30)	34° / 63°	460 lx (43 fc)	125 lx (12 fc)	55 lx (5 fc)
DW Beam / Field Angle Wide diffuser (C-HE80)	55° / 99°	114 lx (11 fc)	35 lx (3 fc)	16 lx (1 fc)
DW Beam / Field Angle Assymmetric diffuser	30° / 50° short axis 46° / 77° long axis	315 lx (29 fc)	83 lx (8 fc)	36 lx (3 fc)

#### Thermal

Ambient operating temperature	0-50° C
Cooling method	passive
BTUs / hour	16 max

#### DMX

Channel Footprint	RGBW: 4 DW: 2
Channel Mapping	RGBW: 1 R, 2 G, 3 B, 4 W DW: 1 CW, 2 WW
Addressing	Gantom Programmer App or DarkBox Programmer
Lowest Dimming Level	0.05%

#### Warranty

Fixture	2 years
---------	---------

#### Certifications

USA / Canada	UL
Europe	CE

Gantom takes light source color rendition very seriously and strives to be a leading manufacturer of LED lighting fixtures that presents the subject in the best light, literally. Using the TM-30-20 documentation and tools provided by the Illumination Engineering Society (IES), we have generated the following report to help with your specification needs as it pertains to the Gantom DMX V2 Dynamic White and Gantom R4 Dynamic White fixtures. These fixtures feature a warm white chip at 2650K and a cool white chip at 6200K. Both chips exhibit high preference and fidelity priority levels per Table E-2 of the ANSI/IES TM-30-20 standard.

## TM-30-20

Specification Criteria for  
**Gantom DMX V2 Dynamic White & Gantom R4 Dynamic White**

CCT	Preference Fidelity Priority	$R_f$	$R_g$	$R_{cs,h1}$	$R_{f,h1}$	$R_a$ (CRI)
2650K	<b>P2/F2</b>	91	97	-2%	93	<b>95</b>
4200K	<b>P1/F2</b>	91	100	+1%	93	<b>92</b>
6200K	<b>P1/F2</b>	90	99	+1%	92	<b>93</b>

Table E-2. Recommended Specification Criteria.

		Design Intent (The desired effect of color rendition on the illuminated environment)		
		Preference (P)	Vividness (V)	Fidelity (F)
Priority Level (The balance between allowing for tradeoffs and increasing the likelihood of meeting the design intent)	1	<b>P1</b> $R_f \geq 78$ $R_g \geq 95$ $-1\% \leq R_{cs,h1} \leq 15\%$	<b>V1</b> $R_g \geq 118$ $R_{cs,h1} \geq 15\%$	<b>F1</b> $R_f \geq 95$
	2	<b>P2</b> $R_f \geq 75$ $R_g \geq 92$ $-7\% \leq R_{cs,h1} \leq 19\%$	<b>V2</b> $R_g \geq 110$ $R_{cs,h1} \geq 6\%$	<b>F2</b> $R_f \geq 90$ $R_{f,h1} \geq 90$
	3	<b>P3</b> $R_f \geq 70$ $R_g \geq 89$ $-12\% \leq R_{cs,h1} \leq 23\%$	<b>V3</b> $R_g \geq 100$ $R_{cs,h1} \geq 0\%$	<b>F3</b> $R_f \geq 85$ $R_{f,h1} \geq 85$

Table note: All criteria assume a polychromatic environment with average horizontal illuminance between 200 and 700 lux and uniform chromaticity.

Table E-2 of the ANSI/IES TM-30-20 Standard Available for Free Download:  
<https://store.ies.org/product/tm-30-20-ies-method-for-evaluating-light-source-color-rendition/>

# ANSI/IES TM-30-18 Color Rendition Report

Source: Dynamic White LED - 100% WW 0% CW

Manufacturer: Gantom

Date: 3/19/2021

Model: Gantom DMX V2

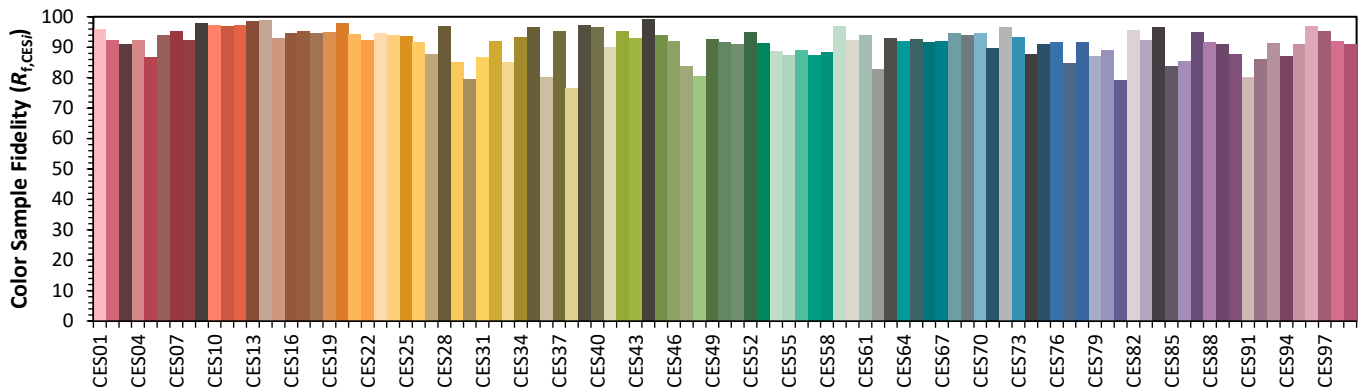
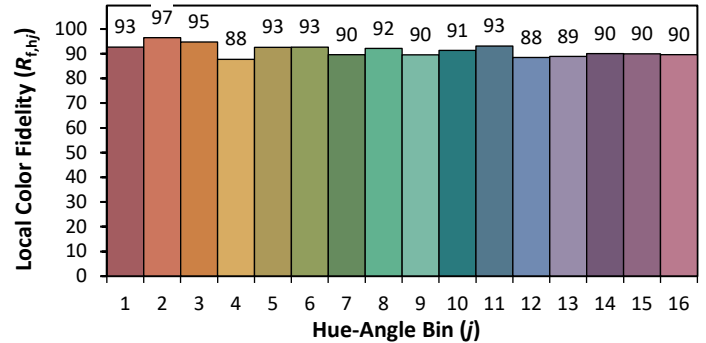
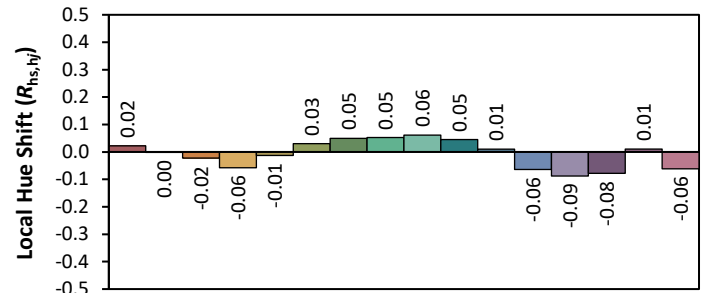
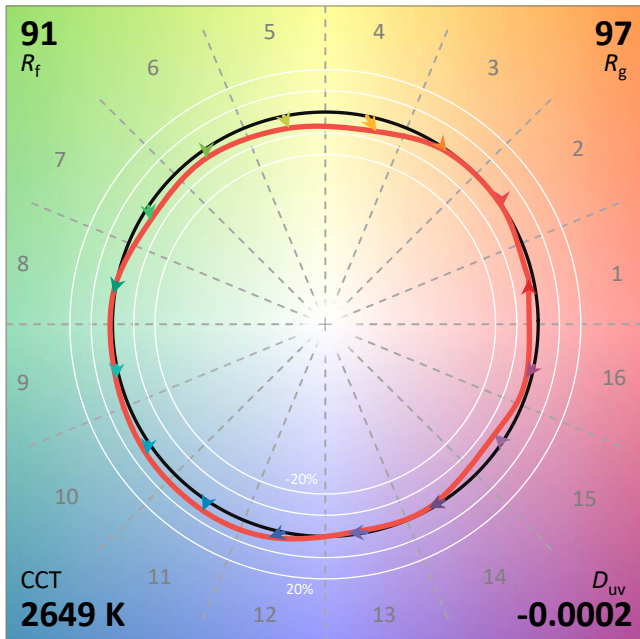
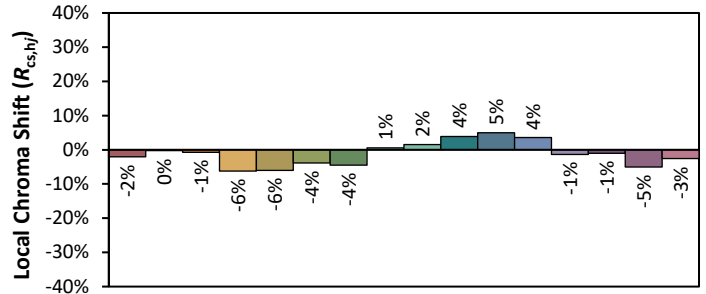
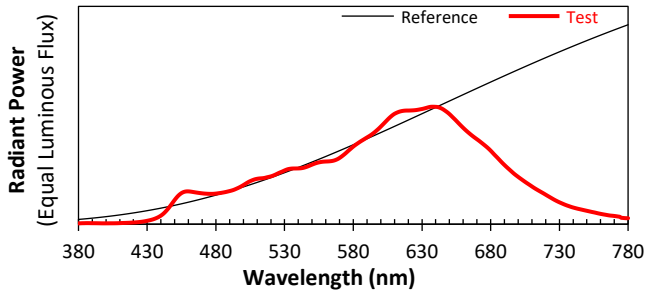

Notes: This is a recommended method for displaying ANSI/IES TM-30-18 information.

x 0.4637  
 y 0.4108  
 u' 0.2649  
 v' 0.5280

CIE 13.3-1995  
 (CRI)

R<sub>a</sub> 95  
 R<sub>g</sub> 83

# ANSI/IES TM-30-18 Color Rendition Report

Source: Dynamic White LED - 50% WW 50% CW

Manufacturer: Gantom

Date: 3/19/2021

Model: Gantom DMX V2

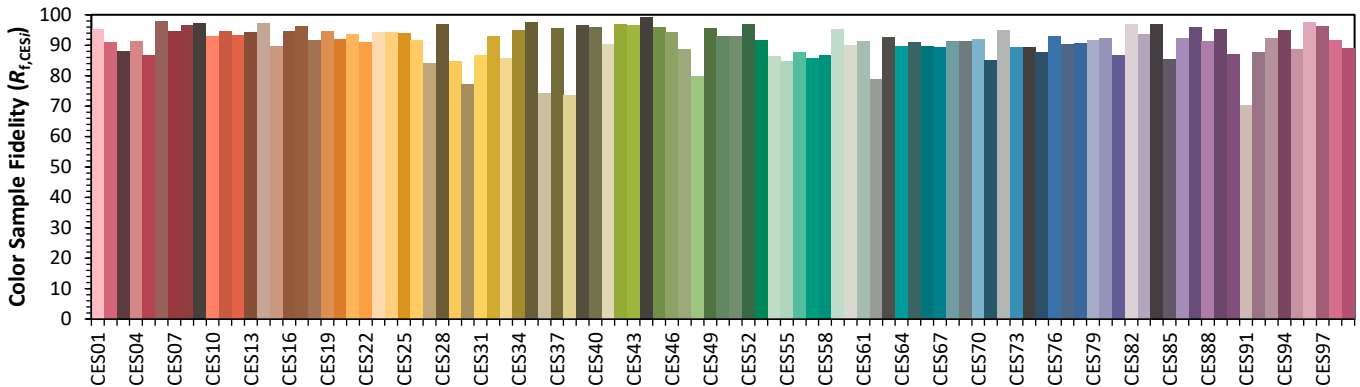
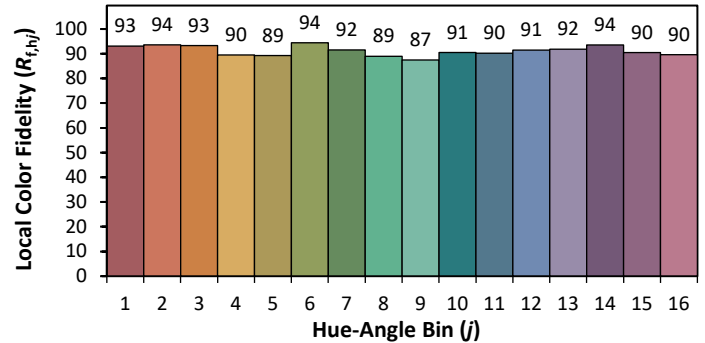
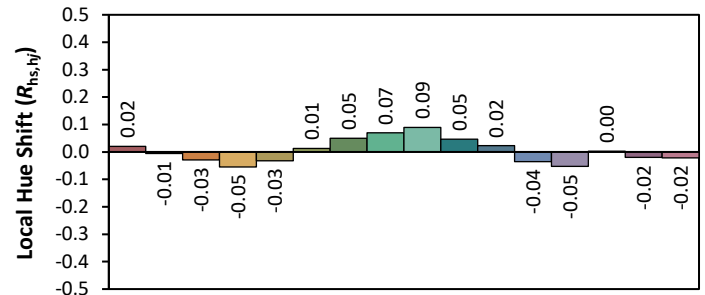
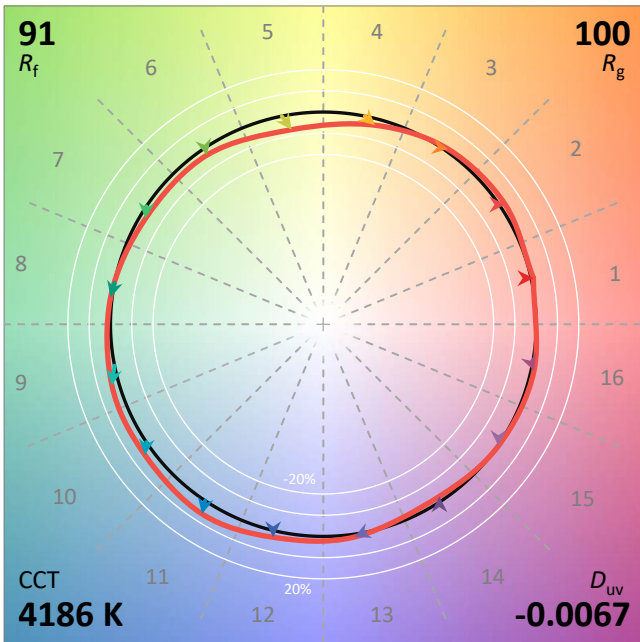
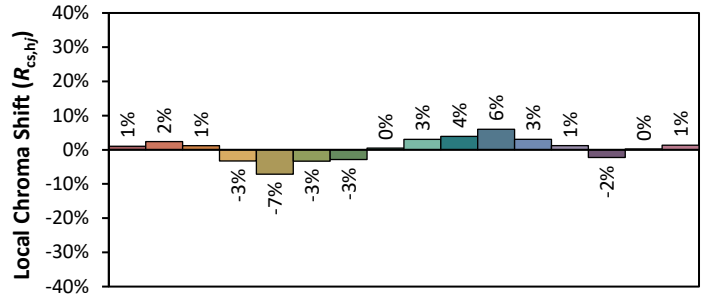
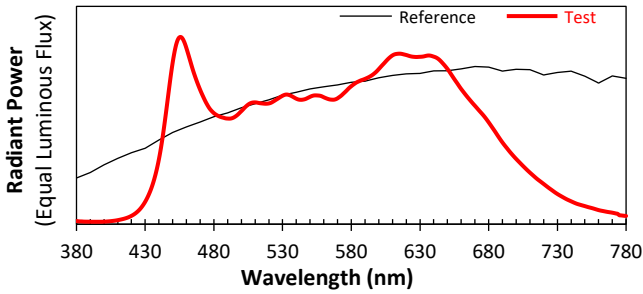

Notes: This is a recommended method for displaying ANSI/IES TM-30-18 information.

x 0.3688  
y 0.3555  
u' 0.2260  
v' 0.4901

CIE 13.3-1995  
(CRI)

R<sub>a</sub> 92  
R<sub>g</sub> 84

# ANSI/IES TM-30-18 Color Rendition Report

Source: Dynamic White LED - 0% WW 100% CW

Manufacturer: Gantom

Date: 3/19/2021

Model: Gantom DMX V2

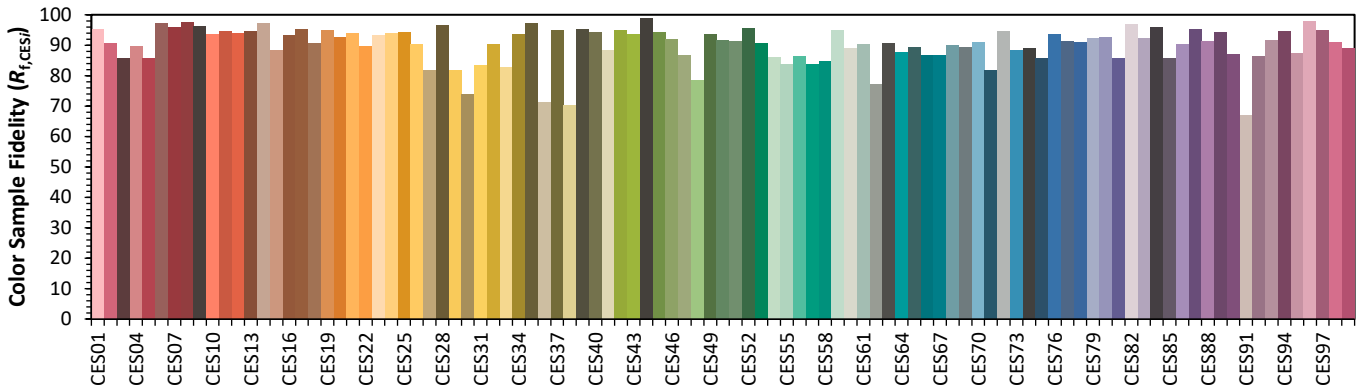
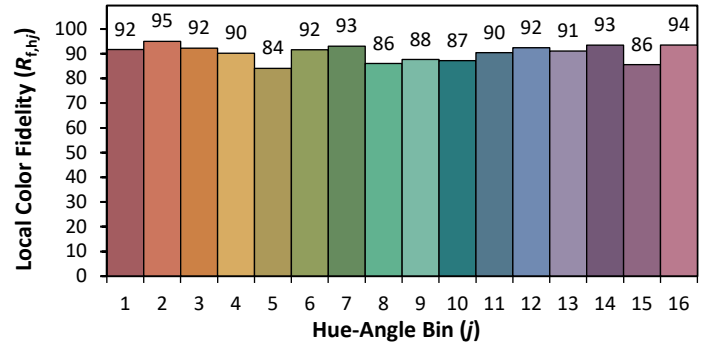
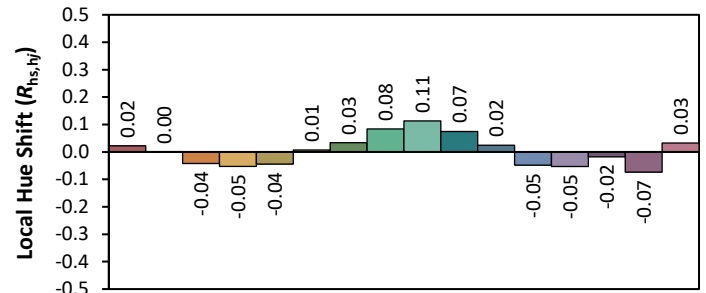
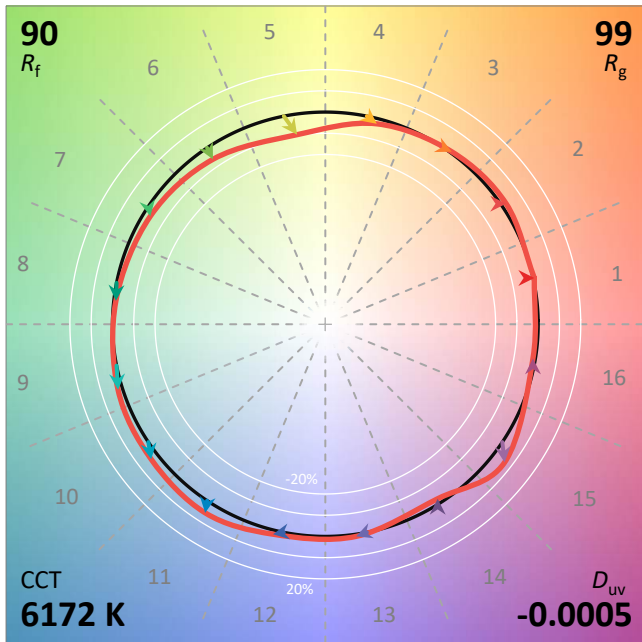
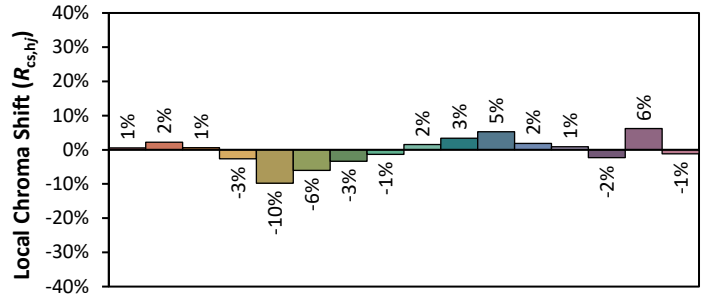
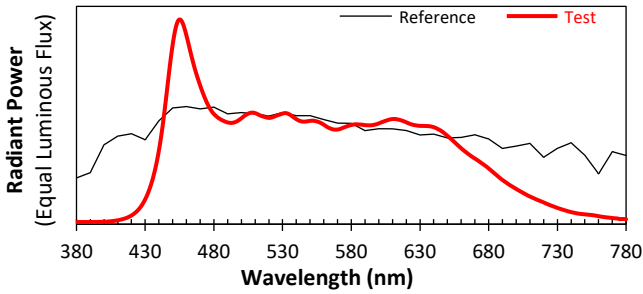

Notes: This is a recommended method for displaying ANSI/IES TM-30-18 information.

x 0.3191  
y 0.3279  
u' 0.2027  
v' 0.4687

CIE 13.3-1995  
(CRI)

R<sub>a</sub> 93  
R<sub>g</sub> 87