

SPar Light

Small Par LED

DL-SPAR18TC/B
DL-SPAR18QW/B
DL-SPAR18VW/B
DL-SPAR17UV/B



Product Features:

RGB, RGBW, Variable White, UV LED Sources

Integral DMX System, with a Settable Variety of Internal Modes and DMX Address

Variety of Interchangeable Optic Lenses to Optimize Beam Output

All Functions Settable via RDM

Numerous Built-in Automatic Effects and Functions

Locking 4 Pin Connections In and Out

Quick Install with Combined Power/Data Cables

IP55 Rated, Applicable for Indoor/Outdoor Areas

CE and RoHS Certified

Robust Aluminum Housing

Mounting Yoke for Easy Focus and Installation



Product Specification

	DL-SPAR18TC/B	DL-SPAR18QW/B	DL-SPAR18VW/B	DL-SPAR17UV/B	
OPTICAL	Light Source	8w COB RGB LED (red, green, blue)	8w COB RGBW LED (red, green, blue, white) LED	8w COB WW/CW 3000/6500K warm white, cool white LED	7w Ultraviolet (UV 385nm) LED Blacklight
	Color Rendering	--	--	CRI: ≥92	--
	Beam Angle	*Included: 15° / 25° Optional: 8° / 45° / 60°			TBD new lenses
	Average Life	25,000 hrs			

ELECTRICAL	Input Voltage	Low Voltage 12-24vDC		
	Frequency	50-60 Hz		
	Power Consumption	8 watts		7 watts
	Current Draw	0.7 Amps		
	Connections	4 pin connector male in and female out		
	Connector Length	6 inch in/out		

CONTROL	Data Connection	4 pin IP65 Locking Connectors			
	Data Control	DMX 512 / RDM			
	DMX Channels	3/6	4/7	2/5	1/3
	Settings	via RDM			
	Modes	DMX or Standalone			
	Standalone Macros	Static Color • Strobe Effect • Double Strobe Effect • Flame Flicker • Power Surge • Ember Effect • Pulse Effect • Blink Effect • Color Wave • Color Chase, with variable speed setting			
	Features	On DMX Loss - source keep/off, Standalone slow fade up turn on			



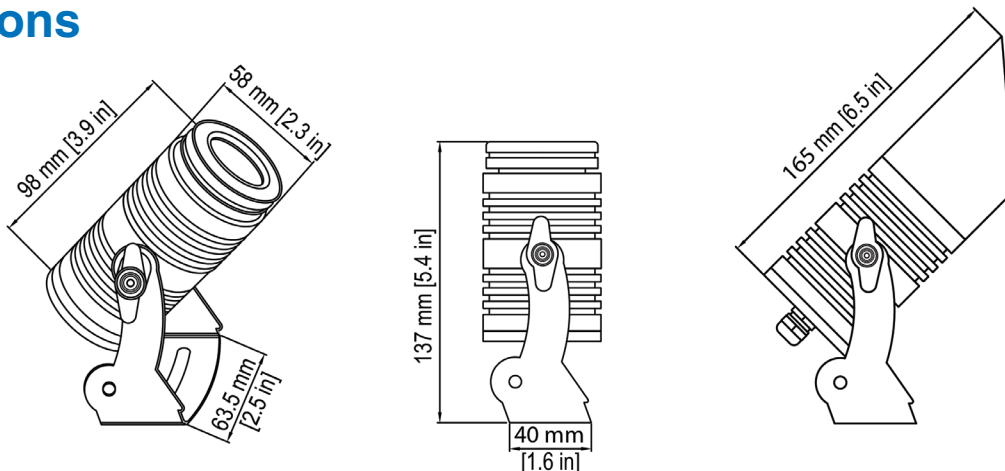

PHYSICAL	Dimensions	Overall Max: 5.4" x 3.25" x 2.5"		
	Weight	0.45 kgs / 0.98 lbs		
	Housing	Aluminum		
	Hardware	Stainless Steel		
	U Bracket	Mounting yoke with 5mm hole		
	Finish Color	Black		

OTHERS	Insulation Rating	IP55		
	Cooling	Passive		
	Certification	CE , RoHS		
	Warranty	2 years		

Dimensions



Optional Accessories





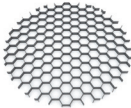





Optional lenses for TH-SPAR17UV/B, TH-SPAR18QW/B, DL-SPAR18TC/B and DL-SPAR18VW/B		
	Product Code	Specifications
	ZOLE1040	Lens LED 8 degrees, Diameter 37mm for Spar Light
	ZOLE1041	Lens LED 15 degrees, Diameter 37mm for Spar Light Included with fixture.*
	ZOLE1042	Lens LED 25 degrees, Diameter 37mm for Spar Light Included with fixture.*
	ZOLE1045	Lens LED 45 degrees, Diameter 37mm for Spar Light
	ZOLE1046	Lens LED 60 degrees, Diameter 37mm for Spar Light

Full Top Hat Snoot		
	Product Code	Specifications
	TA-FHATSPAR/B	Full top hat snoots are used to reduce glare and light spill. This snoot is specifically designed to mount on the front of the Spar Light. Size: Outside diameter 58mm x 83mm Long • Mounts using 2x 2.5mm set screws included • Color: Black • Material: Aluminum

HONEYCOMB		
	Product Code	Specifications
	TA-HONCOMB/SPAR	Honey Comb Louver 1.5mm Black for SPAR Light - use to minimize side glare • Color: Black • Material: Aluminum

Ground Stake		
	Product Code	Specifications
	CL-GSSTAKE1	Ground Stake accessory for mounting Spar Light Small Par LEDs - 8.5" length x 2.75" diameter • Weight: 0.07 kgs/0.15 lbs • Color: Black • Material: Aluminum



Optional Connector Cables		
	Product Code	Specifications
	DA-4PT	4-Pin connectors from 1 male to 2 females • Cable length: 12" wide x 6.5" high • Weight: 0.131 lbs • Color: Black
	DA-4PDPO5	4-Pin male input • Outputs: DMX Data on 5-Pin Female XLR and Power on barrel DC Male 5.5mm x 2.1mm • Cable Length: 12" wide x 6.5" high • Weight: 0.19 lbs • Color: Black
	DA-4PDPI5	4-Pin female to DMX Data 5-Pin Male XLR and 2-Pin Power In • Includes an End of line Terminator • Cable length: 12" wide x 6.5" high • Weight: 0.19 lbs • Color: Black
	DA-4PDPI3	Initial Data Power 4-Pin female to DMX Data 3-Pin Male XLR and 2-Pin Power In • Includes an End of line Terminator • Cable length: 12" wide x 6.5" high • Weight: 0.19 lbs • Color: Black
	DA-4PPIDC	2-Pin Power in tail is used for DMX 4 pin series lights to inject power into T's. Provides power in connector with 20 inch to standard DC 5.5mm round barrel connector. 2-Pin IP female cable to DC 5.5mm x 2.1mm Female barrel connector • Cable length: 20" long x 3/4" diameter • Weight: 0.4 lbs • Color: Black
	DA-4PPODC	4-Pin Power in to DC 5.5mm barrel male connector. Provides power out from end of a 4P cable run, or out of last light. 4-Pin male with 50cm cable to DC 5.5mm male connector • Cable length: 19 inches • Weight: 0.09 lbs • Color: Black
	DA-4PPT	Inline power injector, T split cable with 2-Pin male to 4-Pin male in and out to 4-Pin female • Cable length: 12" wide x 6.5" high • Weight: 0.19 lbs • Color: Black
	4 Pin Male to Female Extension - Color: Black	
	DA-4PE1/2	.5 meter length. • Cable length: 1.64'/19.4" long x 3/4" diameter • Weight: 0.11 lbs
	DA-4PE1	1 meter length. • Cable length: 3.28'/40" long x 3/4" diameter • Weight: 0.2 lbs
	DA-4PE2	2 meter length. • Cable length: 6.56'/79" long x 3/4" diameter • Weight: 0.4 lbs
	DA-4PE3	3 meter length. • Cable length: 9.84'/118" long x 3/4" diameter • Weight: 0.6 lbs
	DA-4PE5	5 meter length. • Cable length: 16.4'/197" long x 3/4" diameter • Weight: 1 lb
	DA-4PE10	10 meter length. • Cable length: 32.8'/394" long x 3/4" diameter • Weight: 2 lbs
	DA-4PPI	Power In cable 2-Pin female to 2 meter/6.56 feet tail with leads • Cable length: 6.5'/78" long x 3/4" diameter • Weight: 0.525 lbs • Color: Black
	Clean and regulated power supply designed for LED lighting. Input voltage: 100-240V AC • Output current: 10000mA • DC jack size: Standard 2.1/5.5mm • IEC to Edison power cord included • Color: Black • Material: Durable ABS plastic chassis	
	DA-PSU12120IDC	12V 120W Supply for up to 6 Spar lights, with 50 ft/15.24 m cable maximum • Certifications: UL E480146
	DA-PSU20200IDC	20V 200W Supply for up to 12 Spar lights, with 100 ft/30.48 m cable maximum • Certifications: CE, ETL 5012405
	DA-PSU24240IDC	24V 240W Supply for up to 12 Spar lights, with 125 ft/38.1 m cable maximum • Certifications: CE



10900 Palmbay Drive, Orlando, FL 32824 U.S.A.
 Phone: 407-857-8770 Fax: 407-857-8771
www.techni-lux.com

07/11/2024