

Ultra**LUX**^{SERIES}



Information specifically for:
DL-ULTRALUX7C6 – Black with RGBWAUV LEDS

V1.1

This manual contains important information.
Please read before operating fixture.



IMPORTANT INFORMATION

Save original packing and documentation for warranty, service and return issues.

Limited Warranty: This warranty covers defects or malfunctions in this equipment. This warranty lasts for a period of one year from date of purchase. It is the owner's responsibility to provide invoices for proof of purchase, purchase date and dealer or distributor. If purchase date can not be provided, warranty period will start at manufacture date. It is the sole discretion of Techni-Lux to repair or replace parts or equipment. All shipping will be paid by purchaser. This warranty does not cover lamps, fuses, belts, power semiconductors, relays, cleaning, standard maintenance adjustments or normal wear items or any problem resulting from the following: improper wiring, incorrect voltage (including low or over voltage conditions and lightning), abuse, misuse, improper maintenance or an act of God or damage resulting from shipping. Warranty will be null and void if the product is altered, modified, misused, damaged, or subjected to unauthorized repairs. Lamps are covered by relevant manufacturer warranty. This warranty gives you specific legal rights, and you may also have other rights which vary from state to state. Any liability for consequential and incidental damages is expressly disclaimed. No other warranty, expressed or implied is made. Techni-Lux liability in all events is limited to, and shall not exceed, the purchase price paid.

Returning equipment and Repairs: All returns must be accompanied by a Return Merchandise Authorization (RMA) number and sent pre-paid. Contact the dealer or Techni-Lux directly to obtain an RMA. The RMA number must be clearly listed on the shipping label. Due care must be exercised in packing all merchandise to be returned. All repairs must be accompanied by a written explanation of the claimed problem or error encountered. Techni-Lux is solely responsible for determining a product's eligibility for coverage under warranty. If returning for consideration of credit, all accessories and documentation, original protective material and cartons must be included and the equipment, packing and carton must be in new resalable condition. Credit for returned merchandise will be issued at the lowest current price and is subject to a restocking fee. No returns accepted on discontinued items. Techni-Lux is not responsible for merchandise damaged in transit and reserves the right to refuse any return that is damaged by the carrier, not accompanied by a Return Authorization Number (RMA#) or sent by freight collect.

Claims: All claims must be made within seven (7) days of receipt of merchandise. Any physical damage must be reported to carrier upon receipt of merchandise.

Please record the following information for future reference:

Model Number: DL-ULTRALUX7C6

Serial Number: _____

Dealer: _____

Date of Purchase: _____

www.Techni-Lux.com

Table of Contents

Specifications	4
Unpacking	5
Purpose of Manual	5
Power	5
Mounting	6
Basic Reference	6
Basic Setup Wiring Diagrams	7
Operating Setting Buttons	7
Fixture Menu (LED Display)	8
DMX-512 Control	9
<i>DMX Data Connection</i>	<i>9</i>
<i>Data Terminator</i>	<i>9</i>
<i>Adapter 5-to-3 pin</i>	<i>9</i>
<i>DMX Start Address</i>	<i>10</i>
DMX Channel Assignments	10
<i>6 Channel Mode</i>	<i>11</i>
<i>10 Channel Mode</i>	<i>11</i>
Maintenance	12
Accessory Items (sold separately)	12
Troubleshooting	13
DMX-512 Background	14

Specifications

Fixture Overview

- RGBWAUV – Red, Green Blue, White, Amber, UV color mixing
- Rugged Heavy Duty Aluminum Housing
- Operating modes: DMX or Standalone
- 3 Pin DMX connectors
- Segmented LED display menu for settings
- Integrated power supply in base
- Floor standing dual yoke
- Adjustable mounting brackets
- Includes two frame rings to hold filters

Physical

Color	Black
Size	9.25" x 11.41" x 4.65"
Weight	7.7 lbs (3.5 kgs)
Housing Material	Aluminum

Environmental

Location	Indoor IP20
Max. ambient temperature	105°F (40°C)
Min. distance to flammable surface	3.3ft (1m)
Min. distance to illuminated surface	1ft (0.3m)

Electrical

Voltage	Auto Ranging 90 - 250vAC, 50-60Hz
Connection	PowerCon In and Pass Thru
Rated Power	72W
Fuses	Internal 2 amp mini 5mm x 20mm
Rating Approval	CE

Control

Digital Protocol	USITT DMX512 (1990)
Channels	6 or 10
Data I/O	3 Pin XLR (Cannon)
Modes	DMX512 or Stand-Alone

Optics

Light Source	7 x 15 watt 6in1 RGBWA+UV LEDS
Beam Angle	Lenses at 15°

Rigging

Orientation	Any
Mounting Points	13mm mounting hole

Unpacking

Immediately upon receipt, carefully unpack and inspect the fixture to verify that all parts are present and have been received in good condition. If any parts appear damaged from shipping or the shipping carton shows signs of mishandling, notify the shipper immediately. Retain carton and all packing material for inspection. In the event that the merchandise is to be returned, the original carton and packing must be used. The customer will be billed for a new carton and packing if merchandise is received without the original carton and packing.

Claims

Physical damage must be reported to the Freight Carrier or Shipping Company upon receipt of merchandise. Damage incurred in shipping is the responsibility of the Freight Carrier or Shipping Company. It is the customer's obligation in the event that merchandise is received damaged, to notify the Freight Carrier or Shipping Company immediately. All other claims not related to damage incurred during shipping must be made to the Dealer or Distributor within 7 days of receiving merchandise.

Returns

Returned merchandise must be in the original packing with a Return Merchandise Authorization number (RMA) clearly listed on the shipping label. Items sent by Freight Collect or without a RMA number will be refused. Call your sales person and request a RMA prior to shipping. Be prepared to provide the model number, serial number and description of the nature of the return. Shipping damage resulting from inadequate packaging is the customer's responsibility. Customer will be charged additional shipping charges to return products received in non original packing and or cartons.

Purpose of Manual

The purpose of this manual is to explain the necessary steps for using this fixture properly and to assure peak performance of said product functions. It is intended for use as a reference by a fully qualified electrician, technician and lighting professional. This manual should never be considered a substitute for any provision of a regulation, state and/or local code. The responsibility of complying with all state and local laws, ordinances, and regulations in regards to installation, maintenance, and operation of this product lies with the buyer and handler of the product. The instructions and precautions set forth in this manual are not necessarily inclusive of or relevant to all applications. Please read the entire manual to fully understand and safely use this product.

Power



Do not apply power to the fixture until power source is verified. Do not attempt to use this fixture if it appears damaged. For protection against electric shock, fixture must be connected to suitable earth ground. Make sure fixture is disconnected from power mains before any service.

This fixture automatically adjusts to mains voltage and frequency 90-250vAC 50/60Hz. The listed power rating is its average wattage under normal conditions. All fixtures must be powered

directly from a switched circuit. This fixture cannot be run on a rheostat or dimmer circuit even if used solely for a 0% to 100% switching. Before applying power to a fixture, check that the fixture's input voltage matches the power source voltage. Consult a qualified electrician if there are any concerns about proper connection to power.

Mounting

Always consult a qualified professional when rigging. Consider access for routine maintenance when selecting a mounting position. This fixture may be mounted in any position provided there is adequate room for movement and ventilation. Mount the fixture securely using the two mounting holes provided on both sides of the base. This fixture features an adjustable base which allows the panel to be tilted at different desired angles. Always keep cords out of the way, thus preventing any trip hazards. Secure all cables properly. Do not mount where the fixture will be exposed to heavy water fall, high humidity, extreme temperature changes or restricted ventilation. Do not obstruct any of the heat sink vents.

Basic Reference

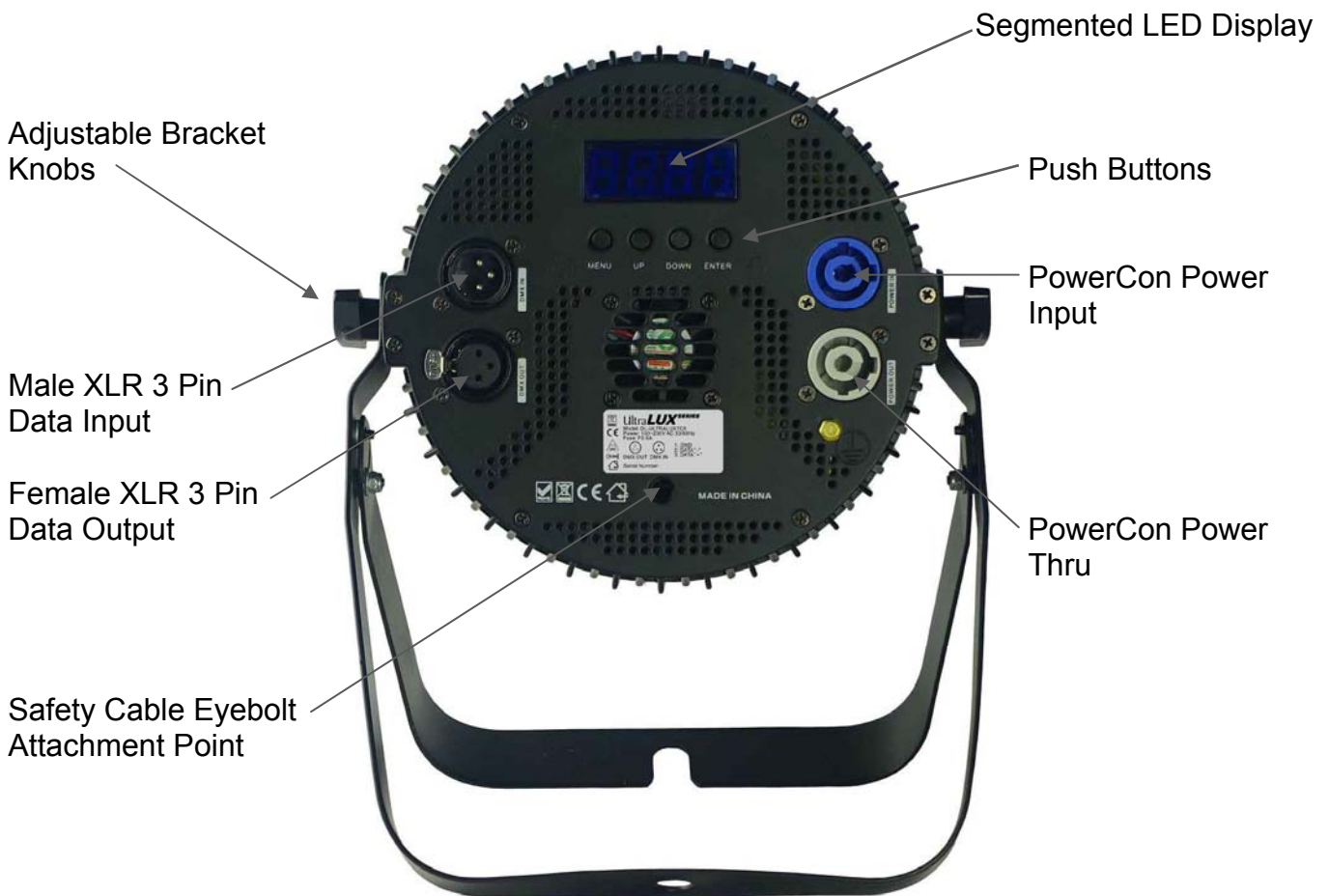

Basic Setup Wiring Diagrams

There are two basic ways to use the fixture. One is in standalone, which does not require the use of any data lines to be connected nor any controller, each fixture would operate independently based solely on the menu setting. The second method, is to use the units in DMX control. The second method requires the fixtures to be wired together via the DMX DATA in and out cables. This allows the units to receive data either from the master unit or the DMX controller. Data wiring is explained in more detail in the DMX Data Connection section of this manual.

Example Block Diagram

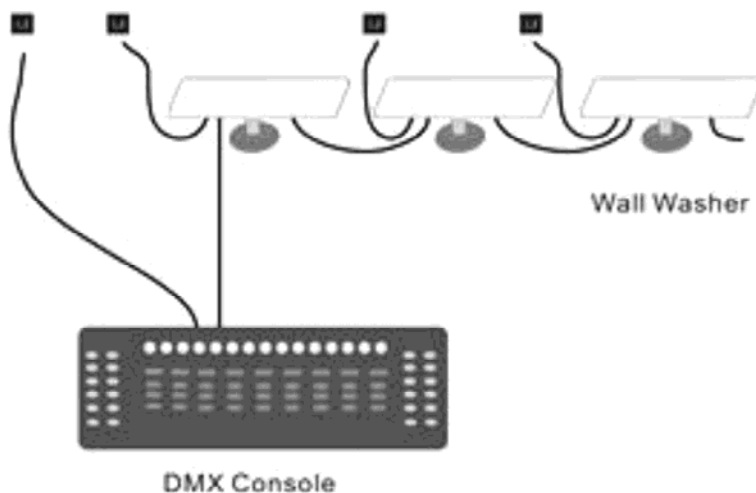

Operating Setting Buttons

The following refers to the settings that are available on this fixture via the LED Segment Control Panel display. All functions are selectable from the display menu located at the back of the fixture using the four push buttons: Menu, Up, Down, Enter

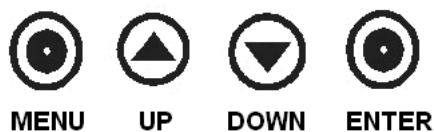











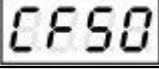

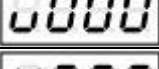
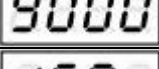

Press MENU to return to the upper menu; Press UP or DOWN to scroll into the menu options or to adjust the values. Press ENTER to confirm.

After power on and initialization, it will show the status before last power off. Then, the unit is ready for settings and operation. Please see the following table for setting information.

Fixture Menu (LED Display)

Use the 4 buttons and display panel located on the rear of the fixture to access its settings.

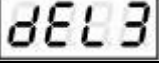
Main Menu	Value	Functions
	001-512	6 channels
	001-512	10 channels
	00-99	Color Fade in & out (slow→fast)
	00-99	Color changing (slow→fast)
	00-99	Color selective
	000-255	Red intensity
	000-255	Green intensity
	000-255	Blue intensity
	000-255	White intensity
	000-255	UV intensity
	000-255	Amber intensity
	/	Demo - Auto run
	/	Sound Active Mode
		Delayed off
		Delayed on 1-3 fast-slow
		
		

DMX-512 Control

Fixtures require a "Start Address" from 1 to 512, setting the first DMX channel containing data for the fixture (see DMX Background). Before addressing fixtures, consult the manual of the system's DMX controller to select a desirable addressing scheme. Valid Start Addresses range from 1 to 512. Fixtures requiring more than one channel for control will read subsequent channels up to the total number of channels required. Since this fixture requires a maximum of 10 channels of DMX, if set to a Start Address of 11 it would use data from channels: 11, 12, 13, 14, 15, 16, 17, 18, 19, and 20. Choose a Start Address so the channels used do not overlap with other fixtures. In some cases, it may be desirable to set two or more same type fixtures to the same Start Address. In this case, the fixtures will be slaved together and respond to the same data. Because all fixtures see the same data, fixtures may be set to any address without concern for the order they are connected by the DMX cables.

DMX Data Connection

This fixture uses 3 pin or 5 pin XLR type connectors. For data use shielded twisted pair cable approved for EIA-422/EIA485 use. Fixtures are connected in Daisy Chain topography: Connection is made from the controller to the DMX-IN of the first light, then from the DMX-OUT to the DMX-IN of the next light and so on. Only one data source can be on a chain and no branching is allowed. The physical order in which the fixtures are connected is not important, use the most convenient.

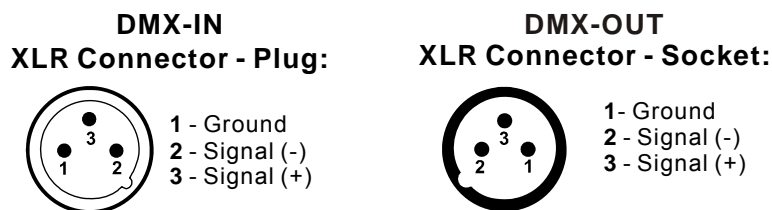

Data Terminator

A Data Terminator can be connected to the DMX-OUT of the last fixture to reduce the effects of signal noise; it is not required for all installations. To make a Terminator, connect a 120-ohm $\frac{1}{4}$ watt resistor across pin 2, Data Negative (S-) and pin 3, Data positive (S+). A qualified technician can determine if a Data Terminator is needed.

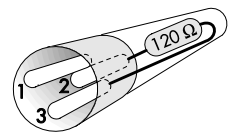

Adapter 5-to-3 pin

Systems using 5 pin DMX interfaces can be accommodated by purchasing 3-to-5 pin adapters or building adapter cables. Numbers designating each pin can be found on connectors. Converting between the two XLR types is done in a pin-to-pin fashion. Connect the shields to pin 1, then connect pin 2 to pin 2 and pin 3 to pin 3, regardless of either connector's gender or pin count. No connection is made to Pins 4 & 5.

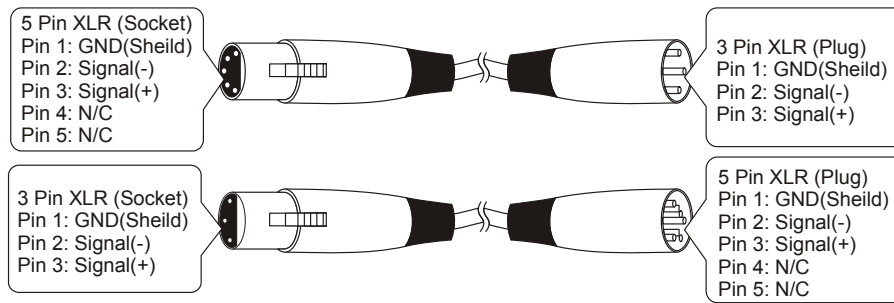

DMX Start Address

More than one fixture may have the same start address, but they will behave the same. Giving a unique start address that does not overlap with any other units allows you to individually control that fixture's features fully. Never allow channels to overlap. This fixture features a 3 channel DMX mode. This will determine the spacing of channels you will need to avoid overlapping of channels when selecting your start addresses.

Example Select Start Addresses for 4 fixtures each requiring 10 channels of DMX.

For this example, start with the first unit set to the first possible Start Address = **1**. This fixture occupies DMX channels 1 thru 10. The next DMX channel available for a Start Address is found by adding the previous fixture's Start Address to its channel requirement: $1+10=11$. To maximize channel usage, we will leave no empty channels between fixtures so the second Start Address is set to DMX channel 11 and that fixture occupies channels 11 thru 20. The third fixture will be addressed $11+10=21$ and occupy channels 21 thru 30. The last fixture is addressed $21+10=31$ and will occupy channels 31 thru 40. Thus, 4 fixtures using 10 channels each have Start Addresses of **1, 11, 21** and **31** and the next free channel in the system is $31+10=41$.

DMX Channel Assignments

This fixture features a 6 or a 10 channel DMX mode. Using the 10 channels allows full control of this fixtures color mixing or blending capabilities. The different channel assignments are shown below.

Channel DMX Modes:



(6 Channels) R, G, B, W, UV, A



(10 Channels) Dimmer, Strobe, R, G, B, W, UV, A, Macro, Fade in & out

6 Channel Mode

Channel	Function		Value
1	R	Red intensity	0-255
2	G	Green intensity	0-255
3	B	Blue intensity	0-255
4	W	White intensity	0-255
5	UV	UV intensity	0-255
6	A	Amber intensity	0-255

10 Channel Mode

Channel	Function		Value
1	Dimmer	Master Dimmer (overall off to on)	0-255
2	Strobe	No function	0-1
		Strobe (slow to fast)	2-255
3	R	Red intensity	0-255
4	G	Green intensity	0-255
5	B	Blue intensity	0-255
6	W	White intensity	0-255
7	UV	UV intensity	0-255
8	A	Amber intensity	0-255
9	Marco	No effect	0-9
		R	10-34
		R+G (R same, G brighter)	35-64
		G+B (G bright, R less brighter)	65-94
		G	95-97
		G+B (G same, B brighter)	98-127
		G+B (B same, G less brighter)	128-157
		B	158-160
		B+R (B same, R brighter)	161-190
		R+G+B (R and B are same, G brighter)	191-225
		R+G+B+W+A (R, G and B are same, A, W brighter)	226-255
		10	Fade in & out
R+B	10-63		
R+G	64-127		
G+B	128-191		
R+G+B+W+A+UV	192-239		
Sound Active Mode	240-255		

Maintenance



Make sure fixture is cool and disconnected from power mains before any service.

Weekly operating hours and environmental conditions will establish how often the fixtures need cleaning. Fixtures should be cleaned and inspected at least once a month to maintain optimum performance. Accumulation of dust and fog residue increases heat build up, can lead to malfunctions, overheating and reduction in maximum light output, reduced fixture life and over all performance. Before conducting any maintenance, disconnect fixture from power mains.

- 1) Disconnect fixture from power mains.
- 2) Use a vacuum with a soft brush to remove dust collected on external vents and internal components. If using an air compressor, use low pressures and extreme care to prevent damaging any internal parts or effects.
- 4) Clean all optical elements when the fixture is cold. Use a soft lint free cotton cloth or tissue and cleaner safe for plastics.
- 5) Inspect clamps and safety cables to ensure fixture is secure and safe.

Accessory Items (sold separately)

Order Code	Description
TA-BDR/UL7	4-Leaf Barndoor - Black
CL-CBHALF	Half Cheese-borough Coupler 300kg Max Load
CL-MEGA/B	Mega 2" Pipe Heavy Duty Clamp – ½" bolt - Black
CL-MINI/B	MNB Clamp-Mini 3/4"-2"Pipe - Black
CA-XLR3/5	Pre-made 5' 3-pin XLR Cable
CA-XLR3/10	Pre-made 10' 3-pin XLR Cable
CA-XLR3/25	Pre-made 25' 3-pin XLR Cable
CA-XLR3/50	Pre-made 50' 3-pin XLR Cable
CA-XLR5/5	Pre-made 5' 5-pin XLR Cable
CA-XLR5/10	Pre-made 10' 5-pin XLR Cable
CA-XLR5/15	Pre-made 15' 5-pin XLR Cable
CA-XLR5/25	Pre-made 25' 5-pin XLR Cable
CO-XLRTERM3	XLR 3 Pin Data Terminator
CO-XLR3MTO5F	XLR 3 Pin Male to 5 Pin Female Adapter
CO-XLR5MTO3F	XLR 5 Pin Male to 3 Pin Female Adapter

Troubleshooting

Symptom	Possible Cause / Solution
No Power	Check for power on mains
	Check main fuse and fuse holder
Erratic / No response to DMX	Check data cables: connection and proper wiring
	Check Display settings
	Check Start Address
Incorrectly responds to DMX (Diagnostic technique for DMX issues: Set suspect fixture's Start Address the same as a correctly functioning fixture. If both units then function correctly, issue is programming)	Check Start Address
	Check for overlapping addresses
	Check Menu settings
	Check Data cables (faults and proper wiring)

DMX-512 Background

DMX-512 is a digital data transmission standard developed by the United States Institute for Theater Technology (USITT). It is designed to enable control of lighting equipment. DMX deals solely with the formatting of data for transmission and does not dictate how the data is created or used.

Under DMX, signals are transmitted in much the same way a computer modem transmits data. The Data, divided into channels, is "Framed" using a start bit, high (1), eight data bits and finally, two stop bits, both high (1). DMX uses no parity to check the integrity of the signal. Instead, DMX relies on the ultra low probability of an error occurring in the same place when the data is resent. The rate at which data is sent is fixed at 250k bps, almost four and a half times faster than a 56k modem. This speed allows all data on a DMX chain to be updated more than 44 times every second.

The transmitted data follows a specific format. DMX allows for 512 channels each with eight data bits, giving each channel the possibility of 256 values. When a data "Packet" is sent, all channels are transmitted one after another. Even if the data on a specific channel has not been changed, it must be sent. In a packet, a "start code" of all zeros is sent before the data to identify the signal as a Standard DMX transmission. This start code is transparent to the user and is handled by the controller.

The physical signals are transmitted using a twisted pair of wires and a common shield, a configuration called Balanced. The controller and all receiving equipment are connected using a "Daisy Chain" connection. The signal is jumped from the controller to a piece of DMX equipment. From there, the signal is jumped to the next piece of equipment and so on until the last piece of equipment is connected. No branches are allowed and the signal does not come back to the controller. The final piece of equipment will have only one cable connection. As a result, all equipment connected to the chain will see exactly the same signal whether it is first or last. When connecting equipment, no particular attention needs to be paid to the order in which the equipment is connected. Depending on the conditions and equipment, a line terminator may be required. If there is any question, in most circumstances the addition of a terminator will not degrade the signal. To make a terminator, attach a 120-ohm resistor between the Signal Data Negative and Signal Data Positive pins of a connector in the last piece of equipment in the chain.

The DMX Standard uses 5 pin XLR connectors. However, it is common to see fixtures with 3 pin XLR connectors as these types of balanced or "Lo-Z" cables are common in the audio industry. In either case, pin numbers are the same and carry the same signals.

Pin	Connection
1	Common (Shield)
2	Data Negative (S- or Cold)
3	Data Positive (S+ or Hot)
4	n/c (not used)
5	n/c (not used)



10900 Palmbay Drive • Orlando, FL 32824 U.S.A.
www.techni-lux.com