

IDEA WASH 250

SHOW LIGHTING

- GB
- I
- D
- F
- E
- P

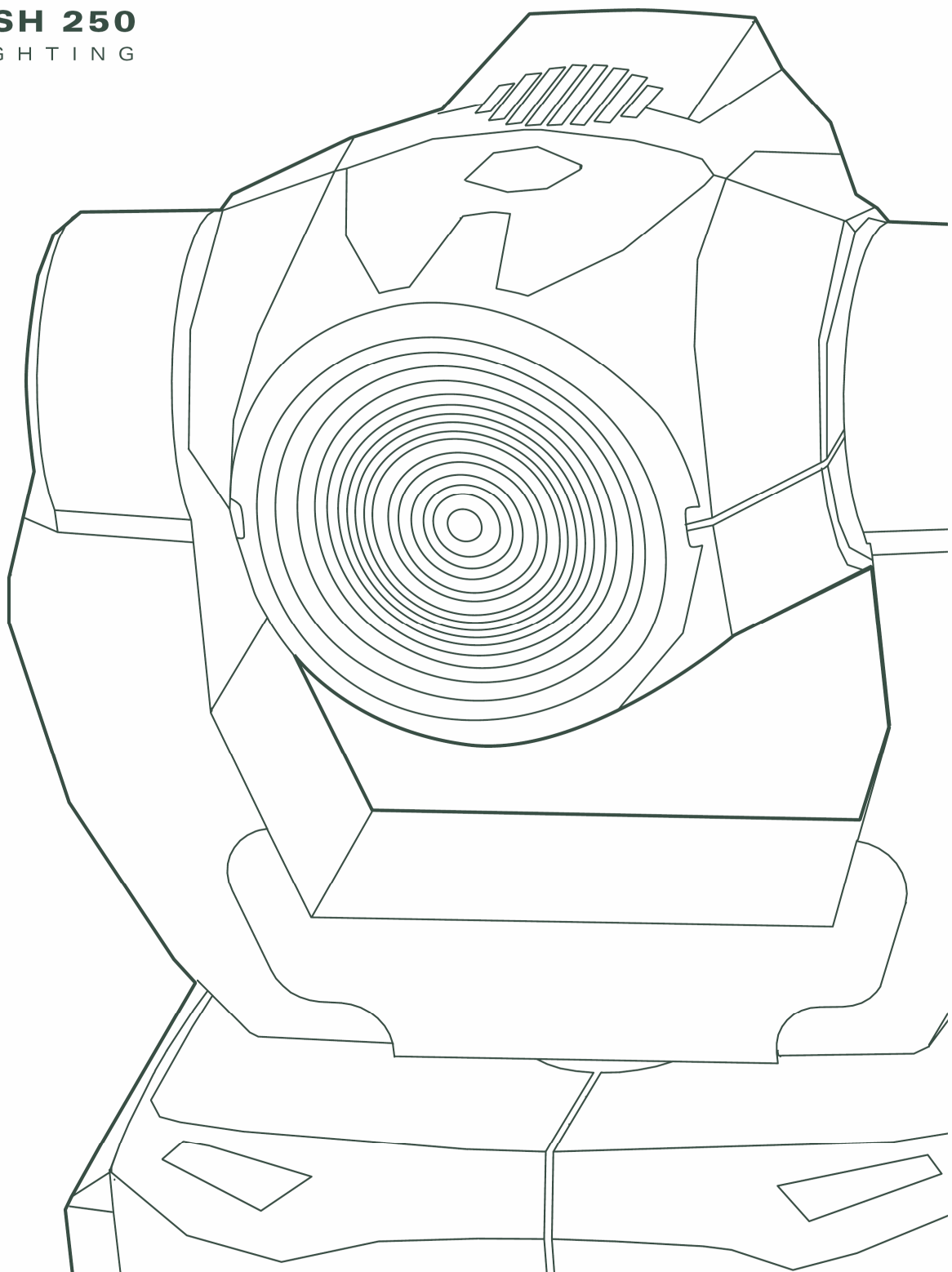

X LINE
show lighting

Vi ringraziamo per aver acquistato un prodotto X Line.

Per ottenere i migliori risultati dal suo utilizzo, vi preghiamo di leggere attentamente questo manuale di istruzioni. Al suo interno troverete le informazioni tecniche e le specifiche d'uso del prodotto. Nelle pagine in appendice troverete inoltre schemi e diagrammi destinati all'assistenza tecnica.

Nell'ottica di qualità, è possibile che l'Azienda apporti migliorie ai suoi prodotti, per cui consigliamo di allegare il manuale al prodotto stesso e di trascrivere il numero di serie nell'ultima pagina della copertina: utilizzando il presente manuale con un apparecchio fabbricato prima o dopo la sua stampa, potrebbero esserci discrepanze fra l'apparecchio e quanto riportato nel manuale stesso.

**Thank you for buying an X Line product.**

To obtain the best results, please carefully read this instruction manual in which you will find technical information and specifications for use of the product, as well as diagrams for technical service in the appendix.

In light of quality, the company may make improvements to its products. Therefore, we recommend that the manual be attached to the product and the serial number copied onto the back cover: using this manual with equipment manufactured before or after its printing, might show discrepancies between the equipment and the information listed in the manual.

Wir danken Ihnen für den Kauf eines Produkts von X Line.

Zur Erzielung der besten Resultate bei der Benutzung bitten wir Sie, die vorliegende Bedienungsanleitung aufmerksam zu lesen. Darin finden Sie die technischen Informationen sowie die Anweisungen für die Benutzung des Produkts. Im Anhang befinden sich außerdem die Schaltpläne und Diagramme für den Kundendienst.

Behält sich das Recht vor, Verbesserungen an den Produkten vorzunehmen und deshalb empfehlen wir, die Bedienungsanleitung dem Produkt stets beizulegen und die Seriennummer auf der letzten Seite des Umschlages einzutragen. Bei der Verwendung dieses Handbuches mit einem Gerät, das vor oder nach der Drucklegung produziert wurde, können sich Abweichungen zwischen Gerät und dem Inhalt des Handbuches ergeben.

Nous vous remercions d'avoir acheté un produit X Line.

Pour optimiser son utilisation, nous vous prions de bien vouloir lire attentivement cette notice où vous trouverez les informations techniques et les caractéristiques d'utilisation du produit. En outre, vous trouverez également, dans les pages en appendice, les schémas et les diagrammes concernant l'assistance technique.

Le concept de qualité, lui permet d'améliorer continuellement ses produits et c'est pourquoi nous vous conseillons de joindre la notice au produit et d'inscrire le numéro de série sur la page de couverture. En effet, si on l'utilise avec un appareil fabriqué avant ou après son impression, il peut y avoir des différences entre l'appareil et ce qui figure dans la notice.

Les estamos sumamente agradecidos por haber elegido un producto X Line.

Para obtener los mejores resultados, les rogamos leer detenidamente el presente manual de instrucciones. El mismo contiene las informaciones técnicas y las indicaciones de uso del producto. Las páginas anexas contienen además los esquemas y diagramas necesarios para la asistencia técnica.



Para mantener la calidad, es posible que la Empresa aporte mejoras sus productos, por ello les aconsejamos conservar el manual junto con el aparato correspondiente y escribir su número de serie en la última página del manual; si en cambio se utiliza el presente manual con un aparato fabricado antes o después de su impresión, es probable que existan discrepancias entre el aparato y las indicaciones del mismo.

Table of Contents

INTRODUCTION: 2
 Features 2
 SAFETY INSTRUCTIONS 3
 GENERAL GUIDELINES 4
 INSTALLATION INSTRUCTIONS 4
 a) Installing or replacing the lamp 4
 b) Mounting the device 6
 Installation via the Omega holders 7
 DMX-512 control connection 8
 Control Board 9
 Main functions 11
 INSTRUCTIONS ON USE: 19
 ERROR MESSAGE 21
 CLEANING AND MAINTENANCE 22
 TECHNICAL SPECIFICATIONS 22

KEEP THIS MANUAL FOR FUTURE NEEDS

For your own safety, please read this user manual carefully before installing the device.

CAUTION	
	Keep this device away from rain and moisture!
	Unplug mains lead before opening the housing

Every person involved with the installation, operation and maintenance of this device has to:

- be qualified
- follow carefully the instructions of this manual

INTRODUCTION:

Thank you for having chosen this professional moving head.
You will see you have acquired a powerful and versatile device.

Unpack the device. Inside the box you should find: the fixture device, a power cable, an XLR connection cable, a pair of Quick-lock omega holders, a safety cable and this manual. Please check carefully that there is no damage caused by transportation. Should there be any, consult your dealer and don't install this device.

Features

- colors :
 - 1 color wheel with 4 dichroic mirrors plus white , rainbow effect
- advanced C, M, Y color system : for a multicolored effect
- automatic run select
- control signal : standard DMX-512 14 channels
- pan and tilt movement :
 - 8 and 16 bit resolution and change the speed : for smooth and precise motion
 - pan : 630° (standard), 540°(optional) / tilt : 265° rotation
- strobe/shutter : high speed dual-blade shutter, 0-13 Hz
- dimmer : mechanical adjustment 0%~100%
- zoom function from 7° to 28°.
- auto programs : 8 pre-built programs can be selected
- lamp on/off control : lamp on/off by DMX512 controller
- display : can turn 180° if the mounting location so requires
- local or remote resetting
- lamp switches ON/OFF locally
- auto test for all functions
- value of each DMX-channel can be displayed
- save program :
 - edit and save the program to the incorporated EEPROM through the front control panel or external controller can save maximum 48 scenes, and run the saved program by the “run” menu from the control panel

SAFETY INSTRUCTIONS

CAUTION	
	Be very careful during installation. Since you will be working with a dangerous voltage you can suffer a life-threatening electric shock when touching live wires

This device has left the factory in perfect condition. In order to maintain this condition and to ensure a safe operation, it is absolutely necessary for the user to follow the safety instructions and warning notes written in this user manual.

IMPORTANT	
Damages caused by the disregard of this user manual are not subject to warranty. The dealer will not accept liability for any resulting defects or problems.	

If the device has been exposed to temperature changes due to environmental changes, do not switch it on immediately. The arising condensation could damage the device. Leave the device switched off until it has reached room temperature.



This device falls under protection-class I. Therefore it is essential that the device be earthed.

The electric connection must carry out by qualified person.

Make sure that the available voltage is not higher than stated at the end of this manual. Make sure the power cord is never crimped or damaged by sharp edges. If this would be the case, replacement of the cable must be done by an authorized dealer.

Always disconnect from the mains, when the device is not in use or before cleaning it. Only handle the power cord by the plug. Never pull out the plug by tugging the power cord.

During initial start-up some smoke or smell may arise. This is a normal process and does not necessarily mean that the device is defective, it should decrease gradually.

CAUTION	
	Never touch device during operation! The housing may heat up
	Never look directly into the light source, as sensitive persons may suffer an epileptic shock.

Please be aware that damages caused by manual modifications to the device are not subject to warranty. Keep away from children and non-professionals.

GENERAL GUIDELINES

This device is a lighting effect for professional use on stages, in discotheques, theatres, etc. This fixture is only allowed to be operated with the max alternating current which stated in the technical specifications in the last page of this manual, the device was designed for indoor use only. Lighting effects are not designed for permanent operation. Consistent operation breaks may ensure that the device will serve you for a long time without defects. Do not shake the device. Avoid brute force when installing or operating the device.

While choosing the installation-spot, please make sure that the device is not exposed to extreme heat, moisture or dust. The minimum distance between light-output from the projector and the illuminated surface must be more than 0,5 meter.

Always fix the fixture with an appropriate safety cable if you use the quick lock cam in hanging up the fixture, please make sure the 4 quick lock fasteners turned in the quick lock holes correctly.



Operate the device only after having familiarized with its functions. Do not permit operation by persons not qualified for operating the device. Most damages are the result of unprofessional operation.

Please use the original packaging if the device is to be transported. For safety reasons, please be aware that all modifications on the device are forbidden.

If this device will be operated in any way different to the one described in this manual, the product may suffer damages and the guarantee becomes void. Furthermore, any other operation may lead to short-circuit, burns, electric shock, lamp explosion, crash, etc.

INSTALLATION INSTRUCTIONS

a) Installing or replacing the lamp

CAUTION	
	Only install the lamp with the device unplugged from the mains.
	The lamp has to be replaced when it is damaged or deformed.

Before replacing the lamp let the lamp cool down, because during operation, the lamp can reach very high temperature.

During the installation of the lamps do not touch the glass bulbs bare handed. Always use a cloth to handle the lamps during insertion and removal.

Do not install lamps with a higher wattage. They generate higher temperatures than which the device was designed for.

For the installation, you need one MSD250/2 GY9.5 lamp :

Procedures:

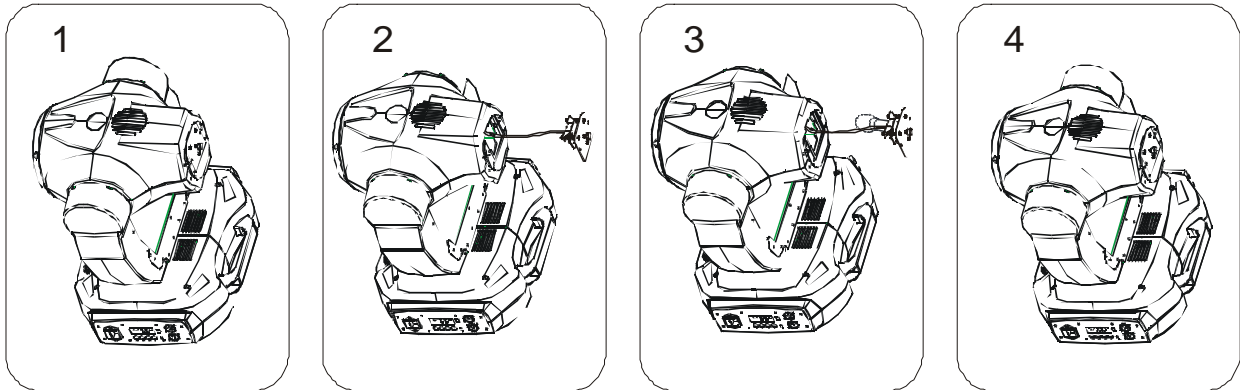

- 1) Unscrew the fixation screws X and Y of the lamp system and carefully remove it from the housing.
- 2) Insert the lamp into the lamp holder.
- 3) Replace the lamp system in the housing and tighten the fixation screws.
- 4) Adjust the lamp as described under lamp adjustment.
- 5) On the access plate there are 3 small screws marked 1,2 and 3, which are used to adjust the lamp holder in the lamp housing. You can adjust the 3 screws to fine-tune the position of the lamp to get the maximum light output as shown below.

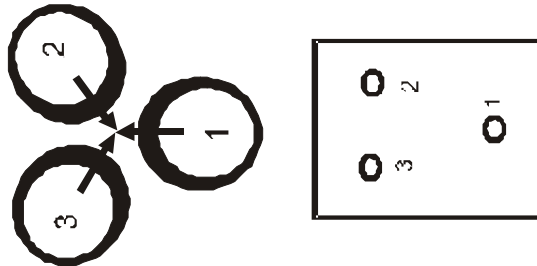

Please remember the lamp is not a hot-restrike type, you must wait for approximately 10 minutes after having turned off the lamp before you can turn it back on again.

CAUTION	
	Do not operate this device with open cover

b) Mounting the device

CAUTION	
	Pleas consider the EN 60598-2-17 and the other respective national norms during the installation. The installation must only be carried out by a qualified person.

The installation of the effect has to be built and constructed in a way that it can hold 10 times the weight for 1 hour without any harming deformation.

The installation must always be secured with a secondary safety attachment, e.g. an appropriate safety cable.

Never stand directly below the device when mounting, removing or servicing the fixture.

The operator has to make sure the safety relating and machine technical installations are approved by an expert before taking the device into operation for the first time.
These installations have to be approved by a skilled person once a year.

CAUTION	
	Before taking into operation for the first time, the installation has to be approved by an expert.

Cautions:

The effect should be installed outside areas where persons may reach it, walk by or be seated.

CAUTION	
	When installing the device, make sure there in no highly inflamm able material within a distance of min. 0,5m

Overhead mounting requires extensive experience, including amongst others calculating working load limits, installation material being used, and periodic safety inspection of all installation material and the device. If you lack these qualifications, do not attempt the installation yourself. Improper installation can result in bodily injury.

CAUTION	
	The electric connection must only be carried out by a qualified electrician.

Before mounting make sure that the installation area can hold a minimum point load of 10 times the device's weight.

Connect the fixture to the mains with the power plug.

Installation via the Omega holders

- (1) Omega-holders
- (2) Clamp
- (3) Safety-rope
- (4) Quick-lock fastener

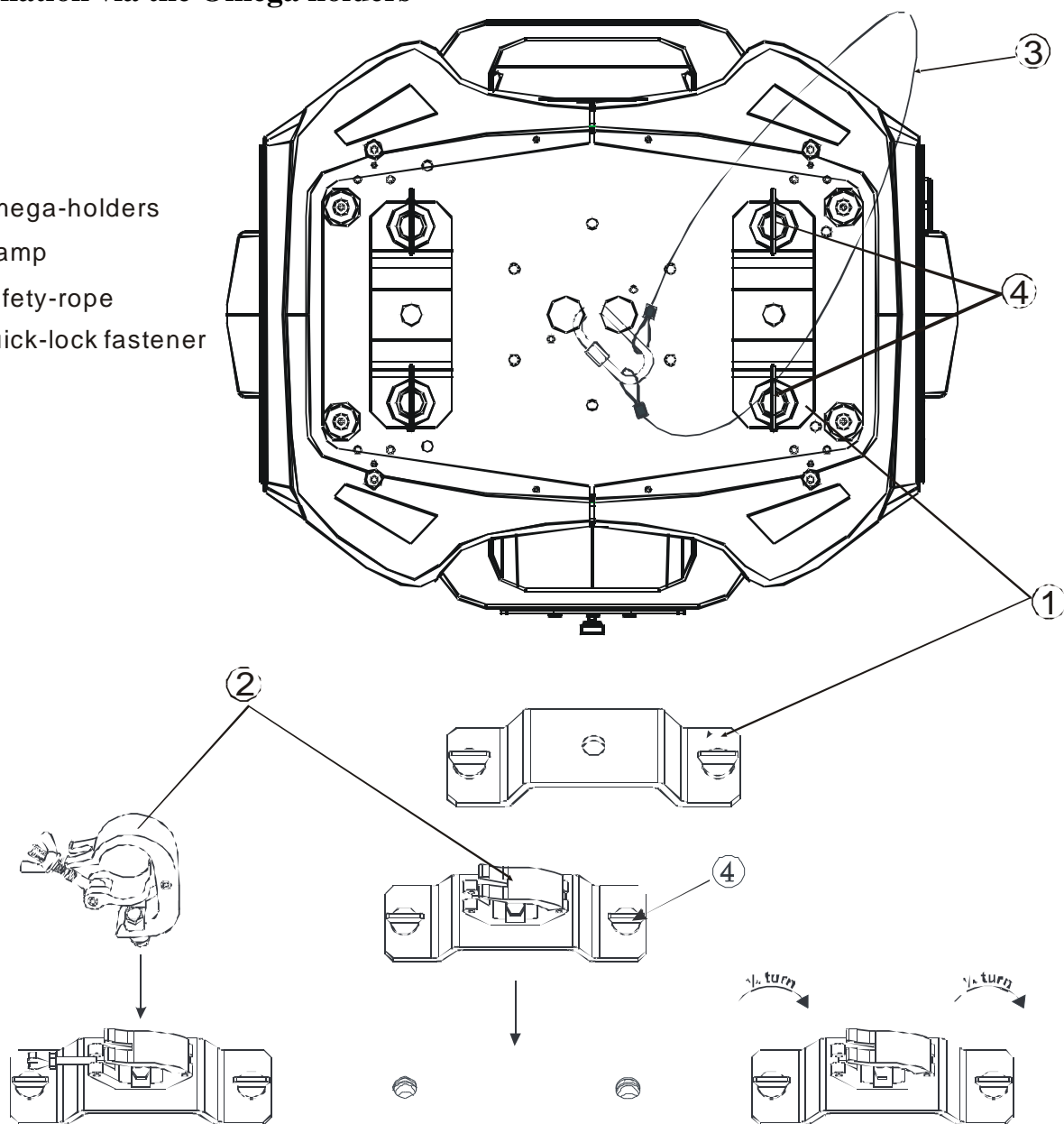

Screw one clamp each via a M12 screw and nut onto the Omega holders.
 Insert the quick-lock fasteners of the first Omega holder into the respective holes on the bottom of the device.
 Tighten the quick-lock fasteners fully clockwise. Install the second Omega holder.
 Pull the safety-rope through the holes on the bottom of the base and over the trussing system or a safe fixation spot. Insert the end in the carabine and tighten the safety screw.

DMX-512 control connection

Connect the provided XLR cable to the female 3-pin XLR output of your controller and the other side to the male 3-pin XLR input of the moving head. You can chain multiple Moving head together through serial linking. The cable needed should be two core, screened cable with XLR input and output connectors. Please refer to the diagram below.

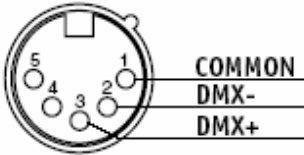

see illustration, taking care with the screen, which must be connected to Pin 1

DMX-512 connection with DMX terminator

For installations where the DMX cable has to run a long distance or is in an electrically noisy environment, such as in a discotheque, it is recommended to use a DMX terminator. This helps in preventing corruption of the digital control signal by electrical noise. The DMX terminator is simply an XLR plug with a $120\ \Omega$ resistor connected between pins 2 and 3, which is then plugged into the output XLR socket of the last fixture in the chain. Please see illustrations below.

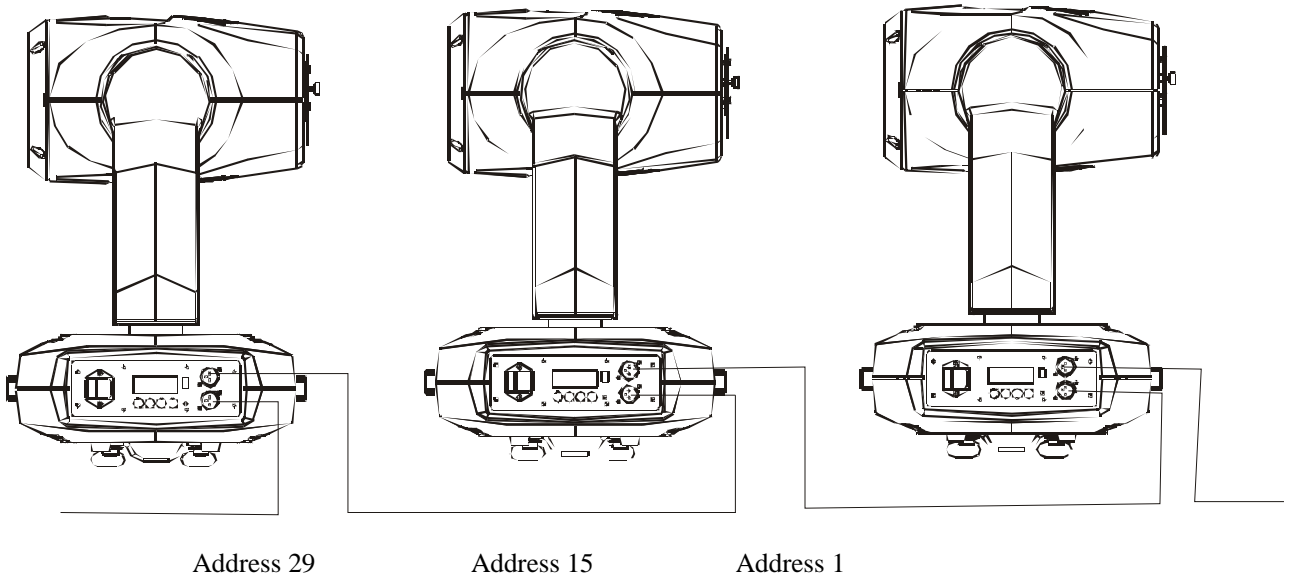
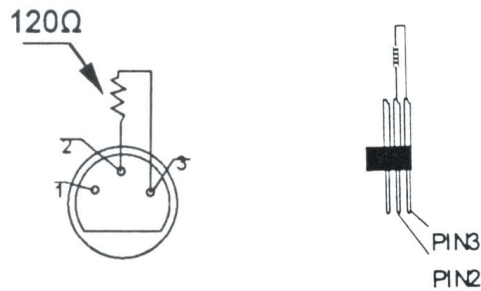

Projector DMX start address selection

All fixtures should be given a DMX starting address when using a DMX signal, so that the correct fixture responds to the correct control signals. This digital starting address is the channel number from which the fixture starts to “listen” to the digital control information sent out from the DMX controller. The allocation of this starting address is achieved by setting the correct number on the display located on the base of the device.

You can set the same starting address for all fixtures or a group of fixtures , or make different address for each fixture individually.

If you set the same address, all the units will start to “listen” to the same control signal from the same channel number. In other words, changing the settings of one channel will affect all the fixtures simultaneously.

If you set a different address, each unit will start to “listen” to the channel number you have set, based on the quantity of control channels of the unit. That means changing the settings of one channel will affect only the selected fixture.

In the case of the spot head, which is a 14 channel fixture, you should set the starting address of the first unit to 1, the second unit to 15 (14 + 1), the third to 29 (15 + 14), and so on.

Note:

The modes of DMX 512 data and lamp are shown via the display:

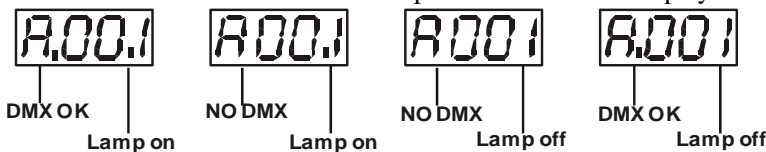

1. After switching on, the device will automatically detect whether DMX 512 data is received or not. If the data is received, the the display will show "A.001" with the actually set address. If there is no data received at the DMX-input, the display will flash "A001" with the actually set address.

This situation can occur if:

- the 3 PIN XLR plug (cable with DMX signal from controller) is not connected with the input of the device.
- the controller is switched off or defective, if the cable or connector is defective or the signal wires are swap in the input connector.

It’s necessary to insert the XLR termination plug (with 120 Ohm) in the last lighting in the link in order to ensure proper transmission on the DMX data link.

2. If the lamp is on, the the display will show "A00.1" with the actually set address. If the lamp is off, the the display will show "A001" with the actually set address.

Control Board

The Control Board offers several features: you can simply set the starting address, switch on and off the lamp, run the pre-programmed program or make a reset.

The main menu is accessed by pressing the Mode/esc-button until the display starts flashing. Browse through the menu by pressing the Up-button or Down-button. Press the Enter-button in order to select the desired menu. You can change the selection by pressing the Up-button or Down-button. Confirm every selection by pressing the Enter-button. You can leave every mode by pressing the Mode/esc-button . The functions provided are described in the following sections.

Default settings shaded.

0	MODE	ADDR	VALU	XXXX A001 (XXXX)	DMX address setting
			SLAV	ON/OFF (SLAV)	Slave setting
		RUN	AUTO	ALON (AU-A)	Automatic Run in Stand Alone
				MAST (AU-M)	Automatic Run as Master
			SOUN	ALON (SO-A)	Sound-controlled Run in Stand Alone
				MAST (SO-M)	Sound-controlled Run as Master
		DISP	VALU	D-XX D-00 (DXXX)	Display the DMX 512 value of each channel
			RDIS	ON/OFF	Reverse display
			CLDI	ON/OFF	Shut off LED display
1	LAMP	OPEN	ON/OFF	Lamp on/off	
		LAAU	ON/OFF	Lamp automated on with power	
		ONLI	ON/OFF	Lamp on/off via controller	
		DELA	D-XX D-15	Delay lamp on	
2	SET	RPAN	ON/OFF	Pan Reverse	
		RTIL	ON/OFF	Tilt Reverse	
		16BI	ON/OFF	Switch 16 bit/8 bit	
		MIC	M-XX M-70	Mic sensitivity	
		AUTO	ON/OFF	Automatic Run by no DMX	
		SOUN	ON/OFF	Sound Run by no DMX	
		REST		Reset	
		LODA	ON/OFF	Restore factory settings	
		VER	V-1.0~V-9.9	Software version	
3	ADJU	LADJ	ON/OFF	Lamp adjustment	
		TEST	T-01~T-30	Test function of each channel	
4	TIME	MATI	0000~9999(hours)	Fixture running time	
		LATI	0000~9999(hours)	Lamp running time	
		CLMT	ON/OFF	Clear fixture time	
		CLLT	ON/OFF	Clear lamp time	
5	EDIT	STEP	S-01 ~S-48	Steps of Program Run	
		REC.	RE.XX	Auto Save Scene	
		SC01 ~ SC48	C-01~C-30	01 XX(00~FFH) 30 XX(00~FFH)	Edit the channels of each scene
			TIME	<u>T</u> -- X(1~9)	Time for each scene
			CNIN	ON/OFF	Edit program via controller

Main functions

MODE - LANP - SET - ADJU - LINE - Edit

MODE - Main menu 0

1. Press [MODE/ESC] to enter the main menu "MODE" (display flashing)
2. Press [ENTER] and select "ADDR", "RUN" or "DISP" by pressing [UP] or [DOWN] button. Press [ENTER] for selecting the desired sub menu.

MODE - Addr
 RUN
 DISP

Addr - DMX address setting, Slave setting

MODE - Addr - VALU - ADDR-AS 11
 SLAV - ON/OFF

VALU - DMX address setting

With this function, you can adjust the desired DMX-address via the Control Board.

1. Select "VALU" by pressing [UP] or [DOWN] button.
2. Press [ENTER], adjust the DMX address by pressing [UP] or [DOWN] button.
3. Press [ENTER] to confirm or pressing [MODE/ESC] to return to main menu.

SLAV - Slave setting

With this function, you can define the device as slave.

1. Select "SLAV" by pressing [UP] or [DOWN] button.
2. Press [ENTER], the display shows "ON" or "OFF".
3. Press [UP] to select "ON" if you wish to enable this function or press [DOWN] to select "OFF" if you don't.
4. Press [ENTER] to confirm or press [MODE/ESC] to return to main menu.

run - Program Run, Master setting

With the function "RUN", you can run the internal program. You can set the number of steps under Step. You can edit the individual scenes under Edit. You can run the individual scenes either automatically (AUTO), i.e. with the adjusted Step-Time or sound-controlled (SOUN). The selection "ALON" means Stand Alone-mode and "MAST" that the device is defined as master.

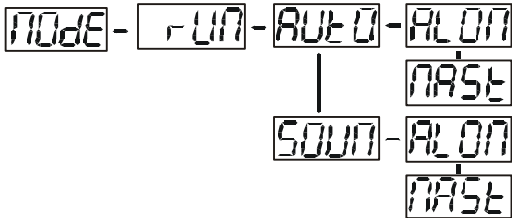

1. Select "AUTO" or "SOUN" by pressing [UP] or [DOWN] button.
2. Press [ENTER] for selecting the desired extension menu.
3. Select "ALON" or "MAST" by pressing [UP] or [DOWN] button.
4. Press [ENTER] to confirm or Press [MODE/ESC] to return to the main menu.

disp - Display the DMX-value, Reverse display, Shut off LED display

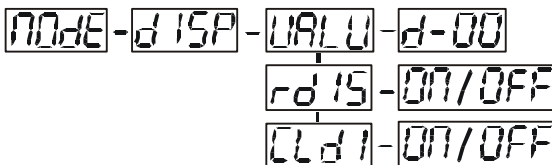

VALU - Display the DMX 512 value of each channel

With this function you can display the DMX 512 value of each channel.

1. Select "VALU" by pressing [UP] or [DOWN] button.
2. Press [ENTER] to confirm; the display shows "D-00". In this setting, the DMX-adjustment of every channel will be displayed.
3. Press [UP] or [DOWN] button in order to select the desired channel. If you select "D-14" the display will only show the DMX-value of the 14th channel.
4. Press [ENTER] to confirm or Press [MODE/ESC] to return to the main menu.
5. The display shows "D- XX", "X" stands for the DMX-value of the selected channel.

rd 15 - Reverse display

With this function you can rotate the display by 180°.

1. Select "RDIS" by pressing [UP] or [DOWN] button.
2. Press [ENTER], the display shows "ON" or "OFF".
3. Press [UP] to select "ON" if you wish to enable this function, or press [DOWN] button to "OFF" if you don't; the display will rotate by 180°.
4. Press [ENTER] to confirm or Press [MODE/ESC] to return to the main menu.

CLDI - Shut off LED display

With this function you can shut off the LED display after 2 minutes.

1. Select "CLDI" by pressing [UP] or [DOWN] button.
2. Press [ENTER], the display shows "ON" or "OFF".
3. Press [UP] to select "ON" if you wish to enable this function or press [DOWN] button to "OFF" if you don't.
4. Press [ENTER] to confirm or Press [MODE/ESC] to return to the main menu.

LAMP - Main menu 1

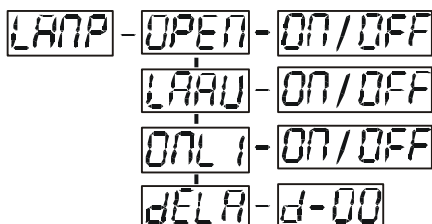

1. Press [MODE/ESC] to enter the main menu (display flashing).
2. Press [UP] or [DOWN] button to select "LAMP".

OPEN - Lamp on/off

With this function you can switch the lamp on or off via the Control Board.

1. Select "OPEN" by pressing [UP] or [DOWN] button.
2. Press [ENTER], the display shows "ON" or "OFF".
3. Press [UP] to select "ON" if you wish to enable this function or press [DOWN] button to "OFF" if you don't.
4. Press [ENTER] to confirm or Press [MODE/ESC] to return to the main menu.

LAAU - Lamp automated on with power.

With this function you can set the lamp be ignited or not when the fixture is power on.

1. Select "LAAU" by pressing [UP] or [DOWN] button.
2. Press [ENTER], the display shows "ON" or "OFF".
3. Press [UP] to select "ON" if you wish to enable this function or press [DOWN] button to "OFF" if you don't.
4. Press [ENTER] to confirm or Press [MODE/ESC] to return to the main menu.

ONL 1 - Lamp on/off via external controller

With this function you can switch the lamp on or off via an external controller.

1. Select "ONL 1" by pressing [UP] or [DOWN] button.
2. Press [ENTER], the display shows "ON" or "OFF".
3. Press [UP] to select "ON" if you wish to enable this function or press [DOWN] button to "OFF" if you don't.
4. Press [ENTER] to confirm or Press [MODE/ESC] to return to the main menu.

DELA - Delay lamp on

With this function you can delay the lamp ignition.

1. Select "DELA" by pressing [UP] or [DOWN] button.
2. Press [ENTER], the display shows "ON" or "OFF".
3. Press [UP] to select "ON" if you wish to enable this function or press [DOWN] button to "OFF" if you don't.
4. Press [ENTER] to confirm or Press [MODE/ESC] to return to the main menu.

SET - Main menu 2

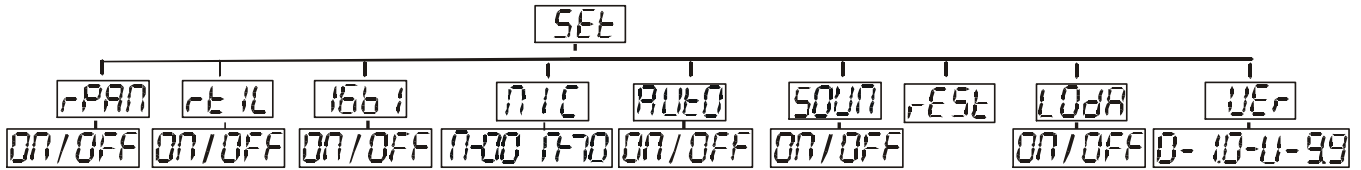

1. Press [MODE/ESC] to enter the main menu (display flashing).
2. Press [UP] or [DOWN] button. to select “SET”.

RPAN - Pan Reverse

With this function you can reverse the Pan-movement.

1. Select “RPAN” by pressing [UP] or [DOWN] button.
2. Press [ENTER], the display shows “ON” or “OFF”.
3. Press [UP] to select “ON” if you wish to enable this function or press [DOWN] button to “OFF” if you don’t.
4. Press [ENTER] to confirm or Press [MODE/ESC] to return to the main menu.

RTIL - Tilt Reverse

With this function you can reverse the Tilt-movement.

1. Select “RTIL” by pressing [UP] or [DOWN] button.
2. Press [ENTER], the display shows “ON” or “OFF”.
3. Press [UP] to select “ON” if you wish to enable this function or press [DOWN] button to “OFF” if you don’t.
4. Press [ENTER] to confirm or Press [MODE/ESC] to return to the main menu.

16b1 - Switch 16 bit/8 bit

With this function you can switch the device from 16 bit to 8 bit resolution.

1. Select “16BI” by pressing [UP] or [DOWN] button.
2. Press [ENTER], the display shows “ON” or “OFF”.
3. Press [UP] to select “ON” if you wish to enable this function or press [DOWN] button to “OFF” if you don’t.
4. Press [ENTER] to confirm or Press [MODE/ESC] to return to the main menu.

MIC - Mic sensitivity

With this function you can adjust the sensitivity of the microphone.

1. Select “MIC” by pressing [UP] or [DOWN] button.
2. Press [ENTER], the display shows “M-XX ”, “XX”stands for the number from 0 to 99 .“M-70” is defaulted value.
3. Press [ENTER] to confirm or Press [MODE/ESC] to return to the main menu.

AUTO - Automatic Run by no DMX

With this function you can automatic run the device by no DMX.

1. Select “AUTO” by pressing [UP] or [DOWN] button.
2. Press [ENTER], the display shows “ON” or “OFF”.
3. Press [UP] to select “ON” if you wish to enable this function or “OFF” if you don’t.
4. Press [ENTER] to confirm or Press [MODE/ESC] to return to the main menu.

SOUN - Sound Run by no DMX

With this function you can sound run the device by no DMX.

1. Select “**SOUN**” by pressing [UP] or [DOWN] button.
2. Press [ENTER], the display shows “**ON**” or “**OFF**”.
3. Press [UP] to select “**ON**” if you wish to enable this function or “**OFF**” if you don’t.
4. Press [ENTER] to confirm or Press [MODE/ESC] to return to the main menu.

REST - Reset

With this function you can Reset the device via the Control Board.

1. Select “**REST**” by pressing [UP] or [DOWN] button.
2. Press [ENTER] to confirm or Press [MODE/ESC] to return to the main menu.

LODA - Restore factory settings

With this function you can restore the factory settings of the device. All settings will be set back to the default values (shaded). Any edited scenes will be lost.

1. Select “**LODA**” by pressing [UP] or [DOWN] button.
2. Press [ENTER], the display shows “**ON**” or “**OFF**”.
3. Press [UP] to select “**ON**” if you wish to enable this function or press [DOWN] button to “**OFF**” if you don’t.
4. Press [ENTER] to confirm or Press [MODE/ESC] to return to the main menu.

VER - Software version

With this function you can display the software version of the device.

1. Select “**VER**” by pressing [UP] or [DOWN] button.
2. Press [ENTER], The display will show “V-XX”, "XX" stands for the version number, such as the display may also show, "V-2.0", "V-9.9" etc.
3. Press [MODE/ESC] to return to the main menu.

ADJU - Main menu 3

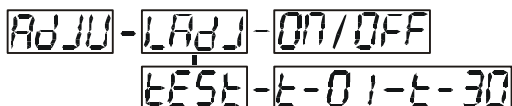

1. Press [MODE/ESC] to enter the main menu (display flashing).
2. Press [UP] or [DOWN] button to select “**ADJU**”.

LADJ - Lamp adjustment

With this function you can adjust the lamp via the Control Board. The shutter opens and the lamp can be adjusted. In this mode, the device will not react to any control signal.

1. Select “**LADJ**” by pressing [UP] or [DOWN] button.
2. Press [ENTER], the display shows “**ON**” or “**OFF**”.
3. Press [UP] to select “**ON**” if you wish to enable this function or press [DOWN] button to select “**OFF**” if you don’t.
4. Press [ENTER] to confirm or Press [MODE/ESC] to return to the main menu.

TEST - Test function of each channel

With this function you can test each channel on its (correct) function. There are 14 DMX channels, and all except channels 12 and 13 can be tested.

1. Select “TEST” by pressing [UP] button.
2. Press [ENTER], the display shows “T-XX”, “X” stands for the channel number.
3. The current channel will be tested.
4. Select the desired channel by pressing [UP] or [DOWN] button.
5. Press [ENTER] to confirm or Press [MODE/ESC] to return to the main menu.

TIME - Main menu 4

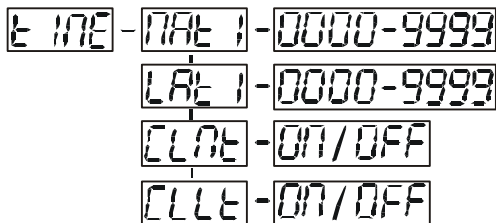

1. Press [MODE/ESC] to enter the main menu (display flashing).
2. Press [UP] or [DOWN] button to select “TIME”.

MATT 1 - Fixture running time

With this function you can display the running time of the device.

1. Select “MATT” by pressing [UP] or [DOWN] button.
2. Press [ENTER], the display shows “XXXX”, “X” stands for the number of hours.
3. Press [ENTER] to confirm or Press [MODE/ESC] to return to the main menu.

LAMP 1 - Lamp running time

With this function you can display the running time of the lamp.

1. Select “LAMP” by pressing [UP] button.
2. Press [ENTER], the display shows “XXXX”, “X” stands for the number of hours.
3. Press [MODE/ESC] to return to the main menu.

CLMT - Clear fixture time

With this function you can clear the running time of the device.

1. Select “CLMT” by pressing [UP] or [DOWN] button.
2. Press [ENTER], the display shows “ON” or “OFF”.
3. Press [UP] to select “ON” if you wish to enable this function or press [DOWN] button to “OFF” if you don’t.
4. Press [ENTER] to confirm or Press [MODE/ESC] to return to the main menu.

CLLT - Clear lamp time

With this function you can clear the running time of the lamp. Please clear the lamp time every time you replace the lamp.

1. Select “CLLT” by pressing [UP] or [DOWN] button.
2. Press [ENTER], the display shows “ON” or “OFF”.
3. Press [UP] to select “ON” if you wish to enable this function or press [DOWN] button to “OFF” if you don’t.
4. Press [ENTER] to confirm or Press [MODE/ESC] to return to the main menu.

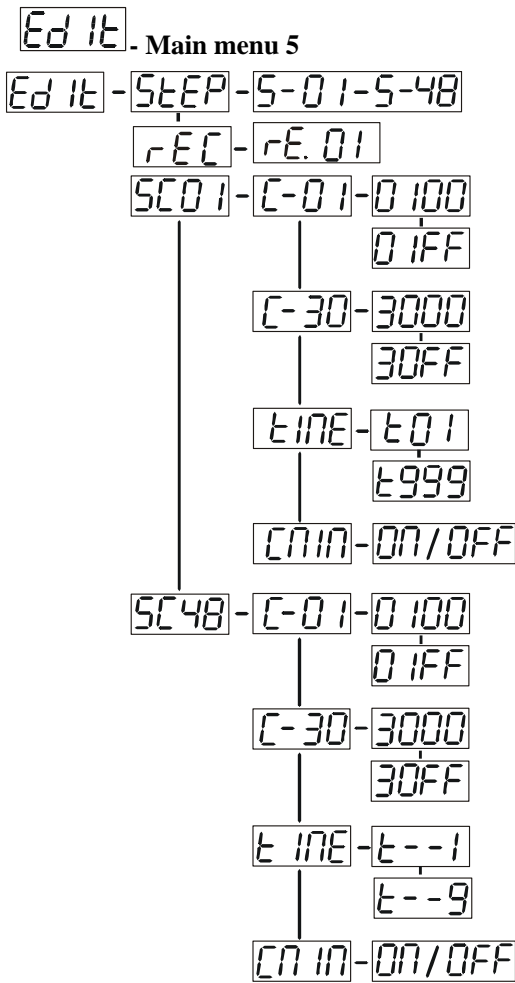

1. Press [MODE/ESC] to enter the main menu (display flashing).
2. Press [UP] or [DOWN] button to select “EDIT”.

STEP - Define the number of steps in Run

With this function you can define the number of steps in the Program Run.

1. Select “STEP” by pressing [UP] or [DOWN] button.
2. Press [ENTER], the display shows “S-XX”, “X” stands for the total amount of steps you want to save, so you can call up to 48 scenes in “RUN”. For example if the “XX” is 05, it means that “RUN” will run the first 5 scenes you saved in “EDIT”.
3. Press [ENTER] to confirm or Press [MODE/ESC] to return to the main menu.

rEC - Auto Save

Records scenes automatically from any external DMX controller and stores them inside the fixtures built-in memory. These scenes can then be recalled without the use of an external controller.

1. Select “EDIT” by pressing [UP] or [DOWN] buttons, press [ENTER]
2. Press [UP] or [DOWN] button until the display shows “STEP”, press [ENTER].
3. Now adjust and set the number of steps by pressing [UP] or [DOWN] buttons. Press [ENTER] to confirm the number of steps, and “PASS” will display briefly.
4. Now press [UP] or [DOWN] button until “REC” is displayed, and press [ENTER].

5. The display will now show “RE.XX”, “XX” stands for the scene number in the internal memory which the scenes from the controller will be stored to. Press [ENTER] when you have chosen the scene number.
6. Call up the scenes on the controller, and the fixture will record the scenes from the controller automatically. After the number of scenes as selected in the “STEP” menu are loaded into the fixture, it will stop the procedure and return to the previous menu.
7. Press [MODE/ESC] to exit the “EDIT” menu and return to the main menu.

SC01

Editing the channels of the individual scenes

With this function you can edit the program to be called up in Run.

a) Editing via the Control Board

1. Select “**SC01**” by pressing [UP] or [DOWN] button.
2. Press [ENTER], the display shows “**SCXX**”, “X” stands for the scene no. to be edited.
3. Change the scene no. by pressing [UP] or [DOWN] button.
4. Press [ENTER], the display shows “**C-X**”, “X” stands for the channel no. Such as “**C-01**”, it means you are editing channel 1 of the selected scene.
5. Select the channel no. you would like to edit by pressing [UP] or [DOWN] button.
6. Press [ENTER] to enter editing for the selected channel , the fixture reacts to your settings. The display shows the DMX value of the edited channel. Such as “ 11XX”, it stands for in the channel 11 of the editing scene, the DMX value is XX , XX is a hexadecimal number value “01-FF”.
7. Adjust the desired DMX value by pressing [UP] or [DOWN] button.
8. Press [ENTER] in order to edit other channels of this scene.
9. Repeat steps 5-9 until you finish setting all the DMX values for all channels of this scene.
10. Once all the channels completed, the display will flash “**TIME**”
11. Press [ENTER] to edit the time needed, the display shows “t-X”, “X” stands for the time needed to run the current scene, value “1-9”. For example, “t-2” means you need 2 seconds to run the current scene.
12. Adjust the desired time by pressing [UP] or [DOWN] button.
13. Press [ENTER] to save the settings for the scene you are editing, the display will change to the next scene automatically.
14. Repeat step 3-14 to edit and other scenes, you can edit and save a maximum of 48 scenes.
15. Press [MODE/ESC] to exit. The number of steps can be defined under “**STEP**” and the scenes can be called up under “**RUN**”

b) Editing via the external controller

Call up the first scene in your controller now.

1. Select “**SC01**” by pressing [UP] or [DOWN] button.
2. Press [ENTER], the display shows “**SC01**”.
3. Press [ENTER], the display shows “**C-01**”.
4. Select “**CNIN**” by pressing [UP] or [DOWN] button.
5. Press [ENTER], the display shows “**OFF**”.
6. Press [UP] or [DOWN] button .the display shows “**ON**”.
7. Press [ENTER], the display shows “**SC02**”. You successfully downloaded the first scene.
8. Adjust the Step-time as described above under point 12.
9. Call up the second scene in your controller now.
10. Repeat steps 5-11 until all desired scenes are downloaded.
11. Press [MODE/ESC] to exit. The number of steps can be defined under “**STEP**” and the scenes can be called up under “**RUN**”

INSTRUCTIONS ON USE:

DMX channel's functions and their values (14 DMX channels):

Channel 1 - PAN movement 8bit :

Channel 2 – Pan fine 16bit

Channel 3 - TILT movement 8bit :

Channel 4– Tilt fine 16bit

Channel 5 - Color Wheel 1 :

0-25	Open / white
26-51	Deep red
52-77	Blue
78-103	Green
104-127	Orange
128-187	Forwards rainbow effect from fast to slow
188-193	No rotation
194-255	Backwards rainbow effect from slow to fast

Channel 6 - Cyan Color Wheel :

0-255	Cyan (0-white, 255-100% Cyan)
-------	-------------------------------

Channel 7 - Magenta Color Wheel :

0-255	Magenta (0-white, 255-100% magenta)
-------	-------------------------------------

Channel 8 - Yellow Color Wheel 4 :

0-255	Yellow (0-white, 255-100% Yellow)
-------	-----------------------------------

Channel 9- Dimmer (intensity):

0-14	Shutter closed
15-255	Intensity 0 to 100%

Channel 10 - Shutter, strobe:

0-31	Shutter closed
32-63	Dimmer control (shutter open)
64-95	Strobe effect slow to fast
96-127	No function (shutter open)

- 128-159 Pulse-effect in sequences
- 160-191 No function (shutter open)
- 192-223 Random strobe effect slow to fast
- 224-255 No function (shutter open)

Channel 11 - Zoom

- 0-255 Zoom 28 - Zoom 7

Channel 12 - Speed pan/tilt movement:

- 0-225 max to min speed
- 226-235 blackout by movement
- 236-245 blackout by all wheel changing
- 246-255 no function

Channel 13 – Lamp on/off, reset, internal programms

- 0-19 colour change normal
- 20-39 colour change to any position
- 40-59 Lamp on
- 60-79 Lamp switch off
- 80-99 Motor reset
- 100-119 Internal program 1
- 120-139 Internal program 2
- 140-159 Internal program 3
- 160-179 Internal program 4
- 180-199 Internal program 5
- 200-219 Internal program 6
- 220-239 Internal program 7
- 240-255 Internal program 8

Channel 14 - Effect wheel

- 0-70 Full beam
- 71-230 Beam shaper
- 231-255 Frost filter

ERROR MESSAGE

When you turn on the fixture, it will make a reset first. The display may show “XXer” while there are problems with one or more channels. “XX” stands for channel 1,2,3,4,5,6,8 who has the testing sensor for positioning .

For example, when the display shows “02Er”, it means there is some error in channel 2. If there are some errors on channel 1, channel 2, channel 5 at the same time, you may see the error message “01Er”, “02Er”, “05Er” flash repeated for 5 times, and then the fixture will generate a reset signal, all the stepper reset. If the fixture remain error message after performing reset more than 3 times, it will detect whether the fixture has more than 3 errors. If the fixture has more than 3 errors (including 3 errors), all the channels can not work properly; but if the fixture has less than 3 errors, only the channels which have errors can not work properly, others can work as usual.

01Er:

(PAN-yoke movement error) This message will appear after the reset of the fixture if the yoke’s magnetic-indexing circuit malfunction (sensor failed or magnet missing) or the stepping-motor is defective (or its driving IC on the main PCB). The yoke is not located in the default position after the reset.

03Er:

(TILT-head movement error) This message will appear after the reset of the fixture if the head’s magnetic-indexing circuit malfunctions (sensor failed or magnet missing) or the stepping-motor is defective (or its driving IC on the main PCB). The head is not located in the default position after the reset.

05Er:

(Color-wheel error) This message will appear after the reset of the fixture if the magnetic-indexing circuit malfunctions (sensor failed or magnet missing) or the stepping-motor is defective (or its drive circuit on the main PCB). The color wheel is not located in the default position after the reset.

11Er:

(Zoom error) This message will appear after the reset of the fixture and if the magnetic-indexing circuit malfunctions (sensor failed or magnet missing) or the stepping-motor is defective (or its driver circuit on the main PCB). The zoom is not located in the default position after the reset.

12Er:

(Effect-wheel error) This message will appear after the reset of the fixture and if the magnetic-indexing circuit malfunctions (sensor failed or magnet missing) or the stepping-motor is defective (or its driver circuit on the main PCB). The effect wheel is not located in the default position after the reset.

CLEANING AND MAINTENANCE

The following points have to be considered during the inspection:

- 1) All screws for installing the devices or parts of the device have to be tightly connected and must not be corroded.
 - 2) There must not be any deformations on the housing, color lenses, fixations and installation spots (ceiling, suspension, trussing).
 - 6) Mechanically moved parts must not show any traces of wearing and must not rotate with unbalances.
 - 7) The electric power supply cables must not show any damage, material fatigue or sediments.
- Further instructions depending on the installation spot and usage have to be adhered by a skilled installer and any safety problems have to be removed.

Note: If the external flexible cable or cord of this device is damaged, it shall be exclusively replaced by the manufacturer or his service agent or a similar qualified person in order to avoid a hazard.

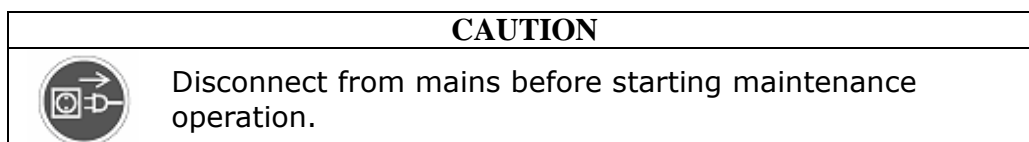

We recommend a frequent cleaning of the device. Please use a moist, lint- free cloth. Never use alcohol or solvents.

There are no serviceable parts inside the device except for the lamp. Please refer to the instructions under “Installation instructions”.

Should you need any spare parts, please order genuine parts from your local dealer.

TECHNICAL SPECIFICATIONS

Power supply :

- 120VAC, 50Hz; 230VAC,50Hz;
- 120VAC,60Hz; 230VAC,60Hz;

Power consumption : max. 400W

Lamp : MSD250/2 GY9.5 socket, Metal Halide

Motors : 11 micro motors

Packing dimensions : 66 x 56 x52 cm

Net weight : 23 KGS;

Gross weight: 27 KGS;

Remark : errors and omissions for every information given in this manual excepted. All information is subject to change without prior notice.



