

www.osram.com



XBO[®] – theater lamps.

Technology and application.



SEE THE WORLD IN A NEW LIGHT

OSRAM



Distributor:



Phone: 407-857-8770

Fax: 407-857-8771

Email: sales@techni-lux.com

www.techni-lux.com

4 Introduction

4 Historical overview

5 General description of XBO® lamps

6 Lamp design

- 6 Terminology
- 6 Bulb
- 7 Electrodes
- 7 Seal
- 10 Base
- 10 Ignition wire
- 10 Filling, fill pressure
- 10 Geometrical tolerances

11 Photometric characteristics

- 11 Luminous flux and luminous efficacy
- 11 Brilliance
- 13 Distribution of luminous intensity
- 14 Spectrum and color properties

16 Electrical characteristics

- 16 General
- 16 Steady-state operation
- 17 Ignition
- 18 Startup
- 19 Current ripple

22 Operating equipment

- 22 Lamp housings
- 23 Rectifiers
- 23 Igniters

25 Operating parameters

- 25 Burning position
- 26 Magnetic arc stabilization
- 27 Turning the lamp
- 28 Cooling
- 29 Current control range
- 30 Operating duty cycle

31 Lamp behavior

- 31 Lamp life
- 31 Blackening
- 33 Arc stability and flicker
- 37 Generation of ozone

39 Handling

- 39 Mechanical installation
- 39 Electrical connection
- 40 Cleaning of lamps
- 41 Transport
- 41 Storage
- 41 Disposal

42 Problems – trouble-shooting – tips

- 42 Lamp does not ignite
- 42 Flicker
- 43 Short lamp life
- 43 Incorrect polarity
- 43 Deformed electrodes
- 43 Burst lamp
- 44 Discoloration of base, cable and cable lugs
- 44 Not enough light
- 45 Uneven illumination
- 45 Shrinking lamp
- 45 Continuous burning

45 Safety

- 45 Pressure
- 45 Brilliance
- 45 UV radiation
- 45 Generation of ozone

46 Index

Introduction

The purpose of this brochure is to give as complete an overview as possible of all questions relating to the use and operation of XBO® lamps. It is therefore aimed at all operators and users of XBO® lamps and at appliance designers, whether of operating equipment such as rectifiers and igniters or of lamp housings and optical systems.

This brochure deals not so much with the physical and photometric principles on which the generation of light in XBO® lamps is based, or the photometric characteristics of the generated radiation, but rather with the practical requirements which must be met to operate the lamps reliably and profitably, the problems which can occur during operation, and ways of solving these problems.

Although the remarks which follow relate mainly to the use of XBO® lamps in film projection (their most important application from the commercial point of view), much of what is said also holds for other applications such as solar simulation or searchlights. The brochure focuses on the high-wattage XBO® lamps rated at over 450 watts which are used in the dominant application; wherever these show marked differences from lower-wattage XBO® lamps, this is always pointed out.

This publication is intended as a reference work and therefore has a detailed table of contents at the front and an index at the back.

Historical overview

XBO® lamps are short-arc discharge lamps based on a steady-state high-current arc discharge in pure xenon gas. They were developed by OSRAM in the middle of the 20th century. In the beginning, they were used as a light source in commercial film projection, where they replaced carbon arc lamps almost overnight. XBO® lamps have been especially popular since about 1970, when lamps were successfully designed which could be operated not only in a vertical burning position, as prescribed until that time, but also horizontally. This development made it possible to increase the brightness of the theater screen by about 30 % with the same lamp wattage.



Fig. 1 In 1984, OSRAM was awarded the coveted OSCAR® by the Academy of Motion Picture Arts and Sciences for developing and perfecting XBO® lamps. Source: Academy of Motion Picture Arts and Sciences.

Over the past 40 years, reliability and lamp life have been constantly improved by continuous development of lamp components and manufacturing procedures. Today, a product range is available from 75 to 12,000W divided into many wattage levels and types.

General description of XBO® lamps

XBO® lamps belong to the family of discharge lamps. In these lamps, light is generated by a discharge arc burning freely in pure xenon gas between two electrodes. The length of the arc is the same as the distance between the two electrodes and is only a few millimeters, even at high power levels of several kilowatts. This means that the lamps come very close to the ideal of a point source of light.

The pressure in the discharge vessel is some tens of bars in operation, in order both to achieve the high spatial level of light concentration desired and to obtain a still acceptable operating voltage for the lamp. Operating voltages are mostly in the order of 20–30V, with extreme values between 15 and 60V. At the wattages usually used, this makes these lamps extremely high-current lamps, currents of up to 200A being advisable and necessary. The current must be provided in the form of well-smoothed direct current by the power supply unit.

One of the main photometric advantages of XBO® lamps, besides their above-mentioned high brilliance due to being point sources of light, is the daylight quality of the light generated. At 6,200K on average, not only do they very closely approach the color temperature of the sun; the color rendering index – the degree to which body colors are reproduced “naturally” – is only a few points under the ideal value of 100, and this color quality cannot be changed or affected, and is always the same, irrespective of lamp type, wattage, lamp life and whether or not dimming is used.

A number of applications also make use of the fact that the lamps can be reignited at any state of cooling, and that when started from cold, the full light output is available almost immediately.

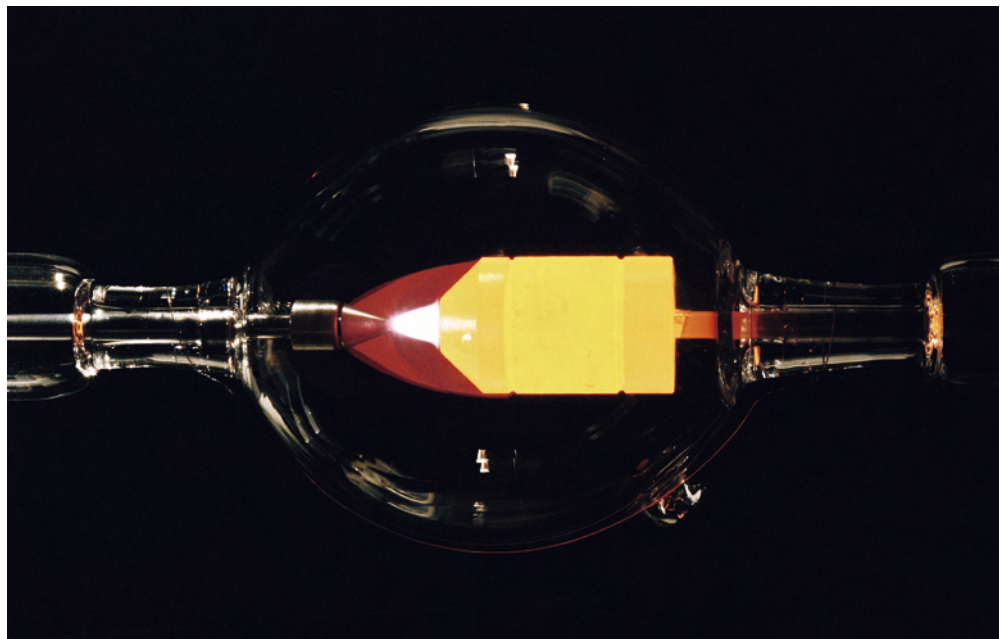

Fig. 2 XBO® lamp in operation.

Lamp design

Terminology

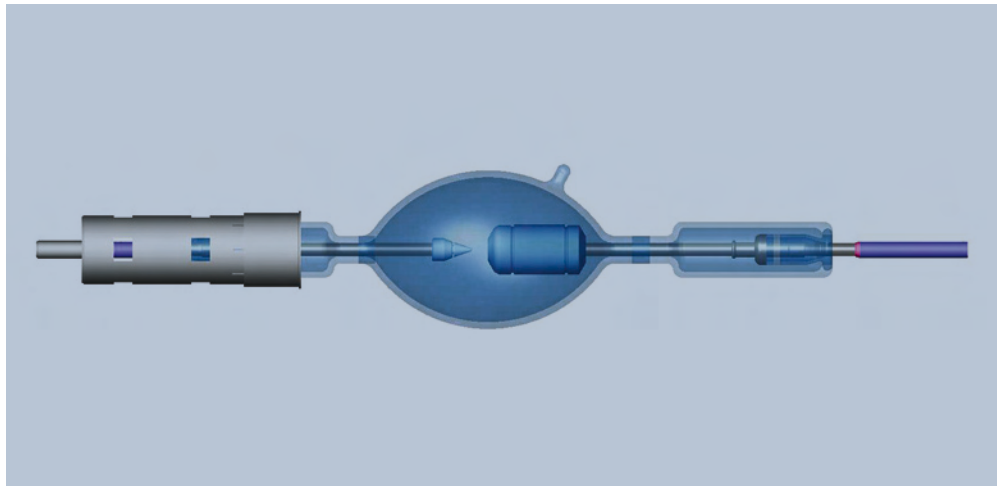

Fig. 3 Schematic sketch of an XBO® lamp showing its main components.

XBO® lamps are double-ended discharge lamps. Fig. 3 is a schematic drawing showing the main components:

The **quartz glass lamp bulb** is the discharge vessel containing the **electrode system** and is filled with xenon gas. The bulge extends outwards into the **lamp shafts** or **lamp necks**.

The lamp's "nose", through which it is filled during manufacture, is called the **exhaust tube** or **exhaust tube tip**. It is located either on the bulb or on one of the lamp necks.

The discharge arc burns between the two **electrodes** that project into the discharge vessel. The electrodes are opposed with a short gap between them, the **electrode gap**. In operation, the electrode gap becomes the **arc length**. The smaller electrode is the **cathode**, the larger the **anode**.

In most types of lamp, the electrodes are mounted on electrode rods.

Both electrodes are **hermetically sealed** into the discharge vessel.

The **bases** are used to make the external electrical connection and to hold the lamp mechanically. One is the cathode base (negative pole), the other the anode base (positive pole).

The **ignition wire** passes round the outside of the bulb; depending on the type of lamp, it either goes from neck to neck or from neck to neck to a base.

Bulb

XBO® lamp bulbs are always made of quartz glass. Only quartz glass can withstand the high mechanical load caused by the operating pressure of some tens of bars and the thermal load at surface temperatures of over 700 °C.

Depending on type and application, a more oval or more round cross section is chosen. The quartz wall is a few millimeters thick. Only the best types of quartz free of striae and bubbles are used in order to give the arc the best possible imaging quality.

The bulk of the quartz glass is generally doped or coated, invisibly to the human eye, to absorb undesirable UV radiation. These lamps have the letters "OFR" added to their lamp designation. XBO® lamps with bulbs made of pure quartz glass generate ozone in air during operation; this is detrimental to health at high concentrations and if inhaled over long periods.

Electrodes

The electrodes in XBO® lamps are always made of tungsten.

The smaller electrode, the **cathode**, supplies the current, i. e. the electrons. The best material for performing this task is doped tungsten. The geometry of the cathode with its relatively sharp tip and (in some types) its heat reflective groove also facilitates the emission of electrons. This shape also lends itself to the formation of a stable and sharply delimited arc base, which is necessary for a high concentration of generated light immediately in front of the cathode tip and for good spatial stability of the arc root.

The **anode** receives the electrons emitted by the cathode. They penetrate the anode at high speed and come to a halt there. The dissipated energy is converted to heat. This heat must be dissipated, and is mostly radiated away. The anode is large and bulky to keep its temperature as low as possible in the interests of long lamp life. The surface is often treated to improve its infrared radiation characteristics; to the human eye it appears either highly polished or pasted grey.

Besides its shape, the other crucial factors that determine how long the anode can withstand the bombardment of electrons are the composition and structure of the material. Whereas in the past, pure, very high density tungsten was used, today doping and strictly controlled thermal and mechanical processing give the metal an internal structure that produces substantially better anode characteristics. The crucial factor is always how long the front face of the anode keeps its shape. The process of attrition is also markedly affected by the special conditions under which a lamp is operated.

By special production processes, OSRAM is able to optimize the W materials for their special applications. Continued improvements of these materials allow continued extension of lamp life and efficiency.

Seal

The seal, of which every XBO® lamp has two, makes the gastight connection for the electric current between the outside world and the inside of the lamp.

As is usual for metals, tungsten has a relatively high thermal expansion coefficient. Quartz glass by contrast hardly expands at all when heated. For this reason, a tungsten rod – the anode rod for example – cannot be embedded in quartz glass, as the tungsten metal would break the quartz glass when it heated up; so certain processes have to be employed to create a seal between glass and metal.

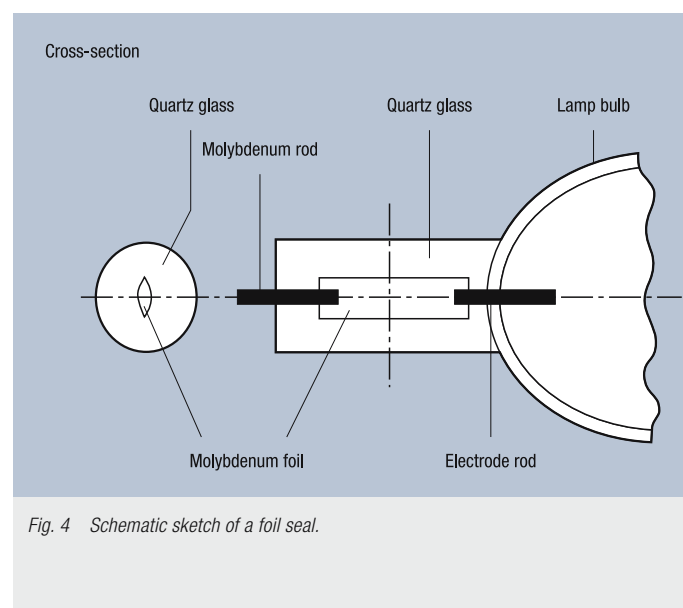

Fig. 4 Schematic sketch of a foil seal.

Process number 1:

The current is conducted through the quartz glass by a molybdenum foil (see Fig. 4, page 7). The foil is only about 20mm thick (thinner than a hair) and is etched to a sharp cutting edge at both sides. When it heats up, the absolute expansion of the foil across its thickness is so slight that the quartz glass is capable of absorbing the force. Across the width, the sharp edges can easily bury themselves in the quartz glass without breaking it. This **foil seal** method is used for all low-wattage XBO® lamps. It cannot be used for higher wattages as the thin foils are only rated up to about 10 amps.

Process number 2:

Instead of a number of foils connected in parallel, a circular foil pressed into the shape of a cup can be used, making a **“moly cup seal”**. This is basically a good idea except for the high cost of manufacturing the cup-shaped foil and the unreliability of the seal along the circular cutting edge.

Process number 3:

The mechanically and electrically most reliable method is to pass the current directly through the rod to which the electrode is fastened. As, however, the rod cannot be embedded in the quartz glass, it is necessary to mediate between the tungsten and the quartz in respect of the expansion coefficient. This is done with a series of different types of glass which are placed around the tungsten rod and whose coefficients of expansion successively fall the further away they are from the tungsten rod: a high coefficient similar to metal directly next to the metal, a low coefficient similar to quartz sealed to the quartz glass, and one or two “mediators” in between. This is known as a **graded seal**. As the seal glass may only be subjected to pressure, the result is a geometry reminiscent of a finger stool turned inside out (see Fig. 5). The important part of the sealing glass is called the seal dome.

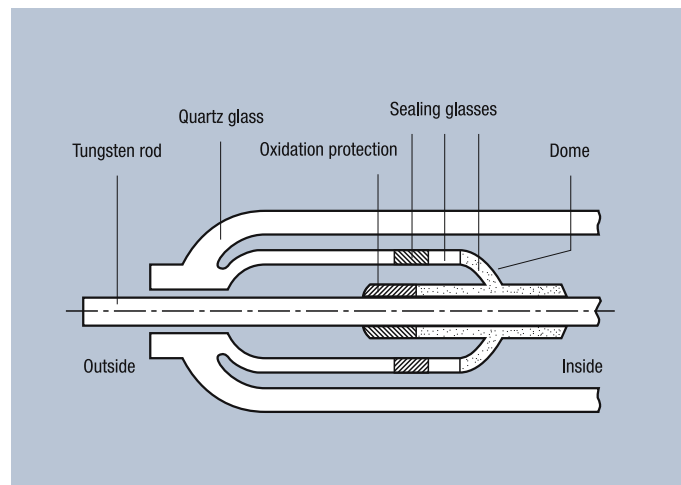

Fig. 5 Schematic drawing of a graded seal.

The graded seal is today regarded as the most reliable and clean type of seal for high-current lamps such as XBO® lamps. As the sealing glass is temperature-sensitive, it must not be located too close to the heat-generating arc and anode. A number of different methods of fixing the heavy electrode solidly in the lamp bulb are used. The most important of these are shown in Fig. 6:

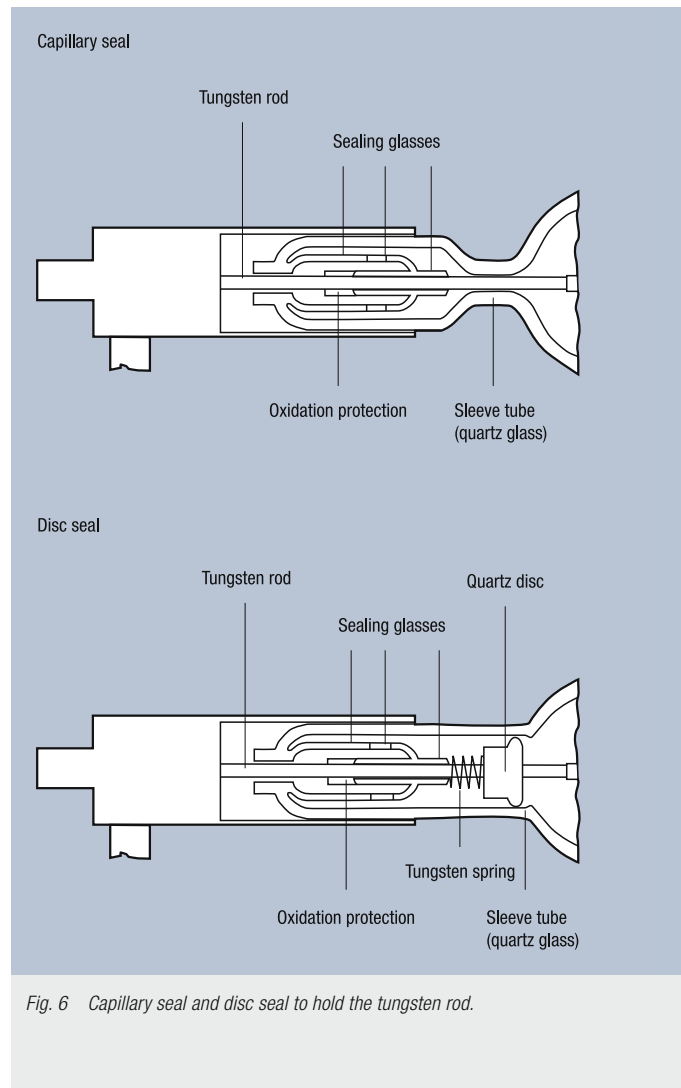

Fig. 6 Capillary seal and disc seal to hold the tungsten rod.

In the **capillary seal**, the sleeve tube is sealed close to the tungsten rod over a certain length. This results in the rod being well supported but a rather delicate mechanical design.

In the **disc seal**, the electrode rod is centered in the large-diameter, robust sleeve tube by a disc shaped rather like a valve head as used in the automobile industry. A tungsten spring presses the disc into its seat.

An important design detail of the graded seal is **oxidation protection**. This consists of a special glass with a relatively low melting point applied externally to the tungsten rod at the seal. Its particularly close physical and chemical bond with the tungsten rod makes a good additional seal against the atmospheric oxygen which tries to penetrate the sealing glass.

Base

The two bases of XBO® lamps are used for electrical connection and mechanical fixing. For high-wattage lamps, they generally consist of metal sleeves fastened to the lamp shafts with a clamping ring assisted by a graphite band. A flexible lead inside the base makes a strain-relieved connection between electrode rod and base. Attached to the sleeves are either a cable, a threaded pin, a simple cylindrical pin or a combination of these. The sleeves are high-gloss nickel-plated for permanently good electrical and thermal contact. Polarity identification marks are usually punched into the bases; these serve both for identification and for cooling the interior of the base.

Ignition wire

The ignition wire is a thin, thermostable iron-nickel wire slung from one lamp neck to the other and – depending on lamp type – sometimes continued as far as the base sleeve. It makes igniting the lamp easier, especially when rectifiers and igniters have diminished in efficiency with increasing age. Its function is twofold: Firstly, it distorts the high-voltage electrical field applied to ignite the lamp, producing inhomogeneities which cause peaks in the field distribution, a condition favorable to sparkover. Secondly, partial discharges take place on it, these can knock electrons from the cathode by a photoelectric effect, and these in turn initiate the discharge.

Filling, fill pressure

XBO® lamps are filled with pure xenon gas. Xenon is the rarest of the stable inert gases and occurs in air at a very low concentration of < 0.00001 %. It can be obtained by liquefying air in an industrial process. It is very expensive compared with other inert gases such as argon and krypton, which are also obtained from air. The gas must meet extremely stringent purity standards to ensure high lamp life. Corrosive impurities may only be present in the ppm (parts per million) range.

Depending on lamp design, cold XBO® lamps are filled to a pressure between 5 and 15 bar. In order to obtain this positive pressure in the lamps, the xenon is frozen into the lamp body during manufacture. The pressure in the lamp rises during operation to about four times the value because of the temperature.

Geometrical tolerances

As point sources of light, XBO® lamps are often used in high-quality optical systems. This requires precise positioning of the arc, or more precisely of its hot spot, the point of maximum brilliance. As these lamps are of hand-crafted molten glass, their overall geometry is naturally subject to greater tolerances than are known from rotationally symmetrical turned metal parts. To facilitate adjustment of the lamps in optical systems, however, and even allow it to be omitted where requirements are not so exacting, the position of the arc relative to a reference base (usually the cathode base) in terms of distance and axially is subject to very close tolerances of usually ± 0.5 mm. All other dimensions may have tolerances of several millimeters. This must be allowed for in the design of appliances and lamp housings.

In some types of lamp, the diameter of the base pin is also closely toleranced if it is to be used to make the electrical connection. A close fitting tolerance provides for a large area of contact.

Photometric characteristics
Luminous flux and luminous efficacy

At typical average wattage levels, about 80 % of the electrical energy put into XBO® lamps is converted into radiation. The rest is lost through heat conduction and convection. Only about 60 % of the energy used is radiated by the electric arc, and most of this is in the invisible near infrared region. The remaining 20 % of the radiation originates from the electrodes (chiefly the anode) and from the bulb which does reach a temperature of about 700 °C.

Referred to visible light, the **luminous efficacy** of the above example is about 30 lm/W and is thus comparable with maximum-load short-life tungsten-halogen lamps. The lower the wattage of an XBO® lamp, or more correctly the lower the lamp voltage, the worse is the luminous efficacy and vice versa. It ranges from only 15 lm/W to 50 lm/W. Lamps with a shorter electrode gap also generally have a lower luminous efficacy.

If the electric current applied to a given lamp is increased, the **luminous flux** increases approximately, proportionately to the lamp current, to the power of 1.5. This improvement in efficiency results from the simultaneous increase in lamp voltage which produces a higher wattage, higher temperature and higher pressure.

Brilliance

For most applications, probably the most important characteristic of XBO® lamps is their **brilliance**. Because the arc in these direct current lamps is geometrically highly compressed, a short distance in front of the cathode (for which the shape of the cathode, its heat balance and the electromagnetodynamic forces in the arc field are responsible), a marked area of maximum brilliance occurs there; this drops off rapidly towards the anode (see Fig. 7).

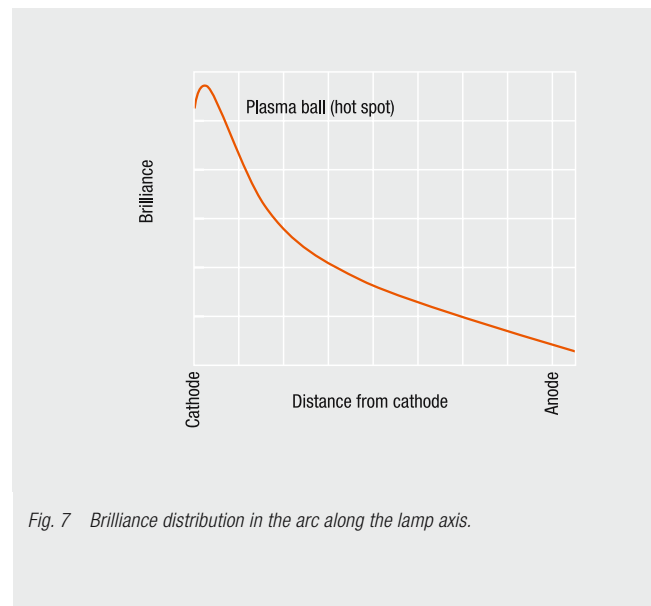

Fig. 7 Brilliance distribution in the arc along the lamp axis.

In the vertical burning position, **brilliance distribution** in the arc is strictly rotationally symmetrical. In horizontal operation, the arc is deflected slightly upwards by the convection in the xenon gas. The amount of deflection is proportional to the electrode gap and inversely proportional to the current.

In order to rate the brilliance of a given lamp in figures, an **average brilliance** is defined (see Fig. 8).

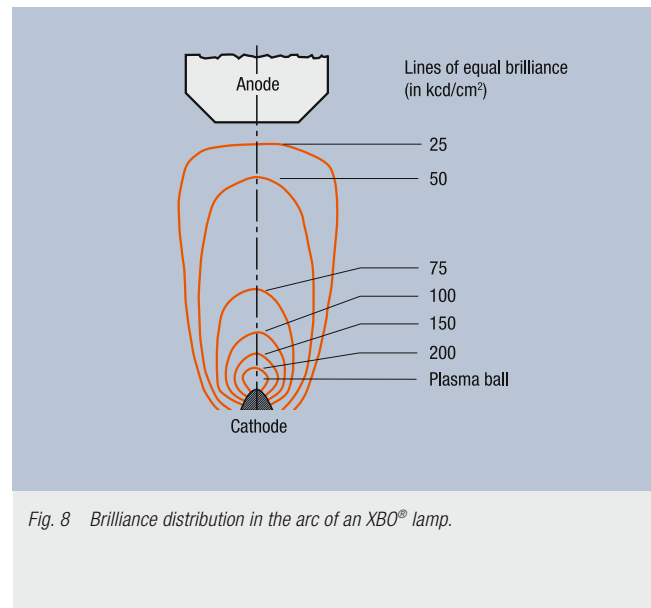

Fig. 8 Brilliance distribution in the arc of an XBO® lamp.

The rules for measuring this are as follows: A small area about 0.02 mm wide over the entire length of the arc along the lamp axis is masked out and its average brilliance determined. This defines the **axial brilliance**. The measured area (the gap) is then moved to both sides of the axis until a value half that of the axial brilliance is measured. This is the average brilliance of the arc. The **luminous area** is obtained from the arc length and the fall in axial brilliance to half its value.

Typical XBO® lamps achieve average brilliance values about half that of the surface of the sun. Sophisticated lamps for special applications with a particularly small electrode gap can exceed the sun's brilliance by a factor of 3 or 4.

The table in Fig. 9 compares the brilliance of some natural and artificial light sources.

Light source	Brilliance (cd/cm ²)
Natural	
Midday sun	100,000 to 150,000
Full moon	0.25 to 0.35
Clear sky	0.3 to 0.7
Cloudy sky	0.01 to 0.1
Artificial	
Short-arc xenon lamp	20,000 to 500,000
Carbon arc lamp	20,000 to 180,000
Clear incandescent lamp	200 to 5000
Clear high-pressure sodium vapor lamp	300 to 550
Fluorescent lamp	0.3 to 2

Fig. 9 Brilliance of selected natural and artificial light sources.

Distribution of luminous intensity

Besides brilliance, an important factor in the design and dimensioning of optical systems for XBO® lamps is the spatial **distribution of luminous intensity** around the lamp.

Because of the rotational symmetry of arc and lamp, the distribution of luminous intensity is also practically the same in all planes through the axis of the lamp (see Fig. 10). This also applies where lamps are operated horizontally; although the arc is deflected to a greater or lesser extent from the lamp's axis of symmetry, most of the radiation originates in the region near the cathode, the root of the arc, and this is virtually unaffected by convective forces.

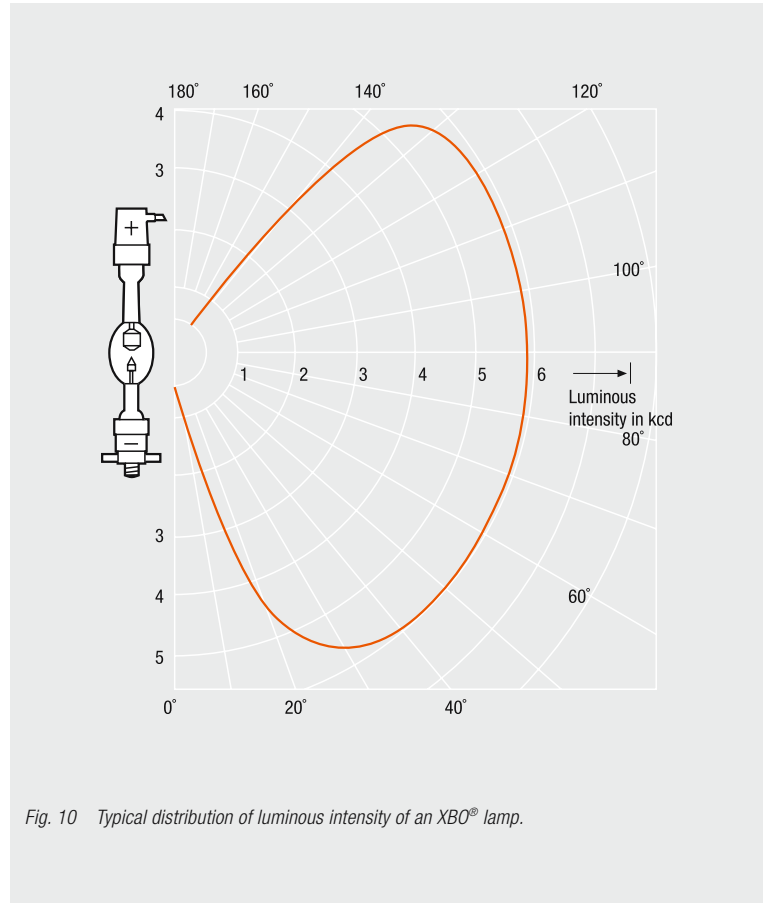

Fig. 10 Typical distribution of luminous intensity of an XBO® lamp.

Because of cathode and anode geometry and their geometrical arrangement, in most lamps the distribution of luminous intensity fills a total solid angle of about 10 steradians almost evenly (full solid angle = $4 \cdot \pi$ = about 12). Hence, the luminous intensity can be approximately derived from the luminous flux of a given lamp as follows:

$$\text{Luminous intensity (cd)} = \text{luminous flux (lm)} \text{ divided by ten}$$

Conversely, the total luminous flux of a lamp can easily be calculated from the measured luminous intensity.

Spectrum and color properties

Besides their high brilliance, it is their spectral color properties that make XBO® lamps attractive for a number of applications. In the visible region between 380 and 780 nm, the **xenon lamp spectrum** very closely follows the spectral curve of a 6,200 K black body radiator (see Fig. 11). It is thus pure white like the midday sun.

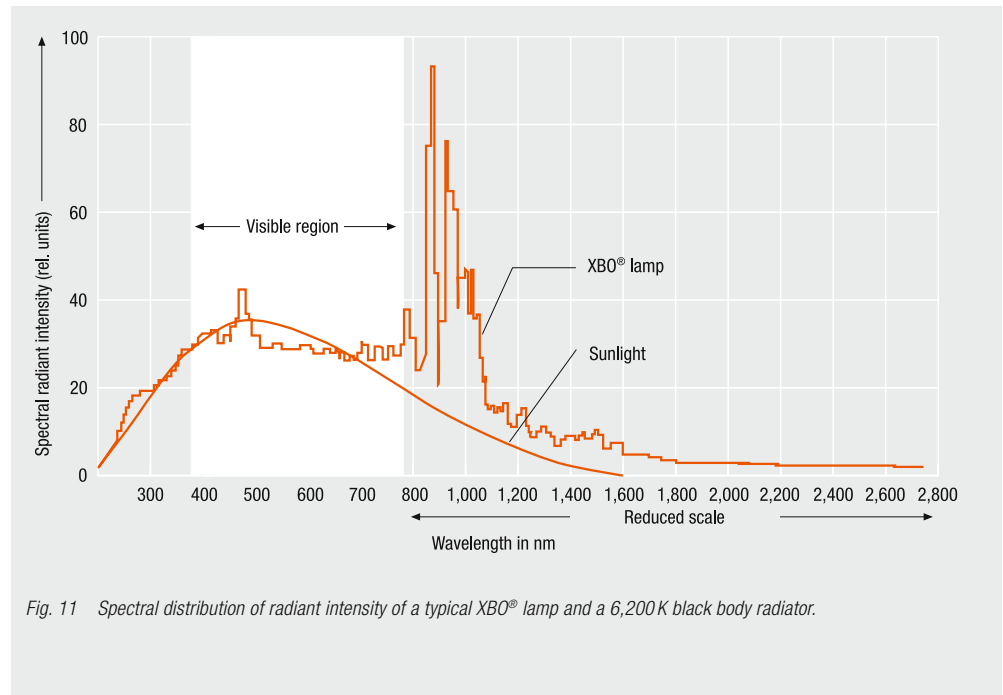

About 6 % of the electric power consumed is emitted in the form of **UV radiation** below 380 nm. The spectrum ends at about 170 nm because it starts to be absorbed by standard quartz glass. Synthetic Suprasil quartz glass, which is especially low in impurities, allows utilization of the arc radiation down to about 155 nm, which decays more or less exponentially towards the shorter wavelengths. Lamps with doped or coated quartz glass are used for all applications in which UV radiation is a nuisance. These can effectively suppress the region below about 240 nm, with the result that no ozone (O_3) is generated during operation in air (and hence in oxygen). The development of “**ozone-free**” lamps has above all meant substantially reduced expenditure on ventilating cramped film projection booths. Fig. 12 shows the spectral transmission of UV by different types of quartz glass.

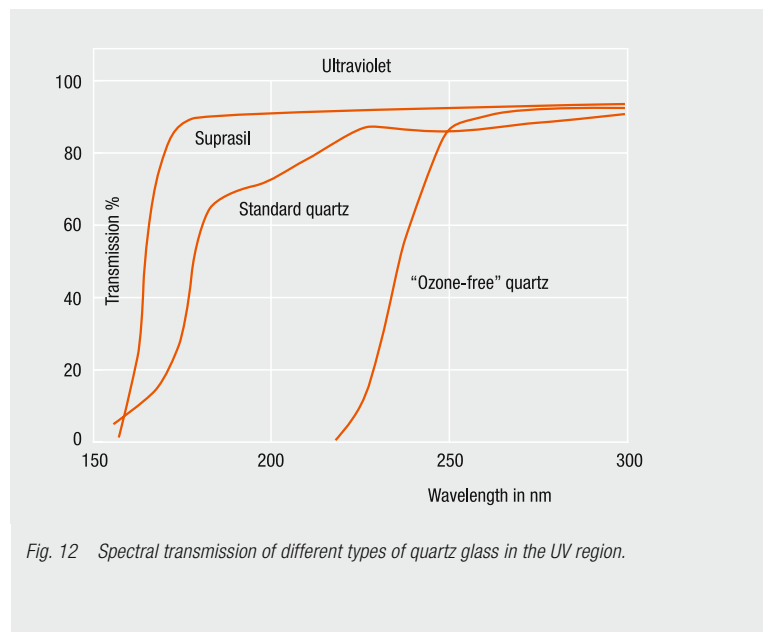

It is important to note that the reduction of UV radiation in “ozone-free” lamps by means of doped or coated quartz glass does not mean that these lamps do not generate UV radiation. The remaining UV radiation above 240 nm is also detrimental to health (see section on “Safety”, page 45).

With regard to the spectra of discharge lamps, the outstanding feature of XBO® lamps is their continuity in the visible region; this is reflected in their color rendering index of about 98.

It is also worthy of note that both color temperature and color rendering index are virtually independent of special operating parameters. Lamp-specific differences in the color temperature of different versions are mainly caused by the varying proportion of electrode radiation: high-wattage lamps with large anodes usually have a lower color temperature, resulting in a higher proportion of red in the spectrum. The fluctuation varies between about 6,000 and 6,500 K.

In particular, the color temperature is virtually independent of:

- Lamp type
- Wattage
- Lamp voltage
- Lamp current
- Dimming/boosting
- Age of the lamp

This stability of the color characteristics of xenon discharge lamps has made them the light source of choice for all high-quality sunlight simulation systems.

Electrical characteristics

General

XBO® lamps are operated with direct current. All attempts to develop alternating current lamps have failed because of short lamp life and high arc instability. The reason for this is that XBO® lamps are high-current lamps, with currents approaching 30 amps even in the low-wattage range of less than 500 W. Such current levels require cathode (negative) and anode (positive) to be highly specialized for their respective tasks: the cathode must deliver a powerful electron stream and the anode must receive it. This definitive electrode layout also means that the consequences of incorrect polarity are disastrous; the lamp will self-destruct within seconds, especially the cathode.

Direct current is generally provided by rectifiers connected to the ac mains. The parameters and characteristics of the operating equipment influence the behavior and particularly the life of XBO® lamps more strongly than for other lamp types. A good understanding of electric lamp behavior is therefore essential for constructing such equipment.

Steady-state operation

Leaving aside ignition and startup of XBO® lamps for the moment, their electrical characteristics can be described by a steady-state current-voltage characteristic.

In the operating range, i. e. the region around the rated current, this **characteristic** is linear and can be described with the following equation:

$$U_L = U_G + I_L \cdot R_L$$

where

U_L = Lamp voltage

U_G = Base voltage

I_L = Lamp current

R_L = Static differential internal resistance

The base voltage is a variable used to describe the virtually linear relationship between current and voltage in the operating range. As Fig. 13 shows, the characteristics rise slightly towards the higher currents. The manufacturing tolerances for a type of lamp are expressed as a plus-or-minus tolerance for the base voltage, typically ± 2 volts. During the course of each lamp's life, its lamp voltage will rise somewhat as a consequence of the cathode tip eroding slightly, causing the arc length to increase. This gives the upper tolerance line. This rise too is in the order of 2 volts.

Most XBO® lamps are **constant-current** lamps, which means that they should be operated at a specific current. The lamp voltage then adjusts itself in accordance with the individual characteristic.

A **current control range** around the rated current is also specified for most XBO® lamps. This can be used to match the brightness of a lamp to individual requirements or to compensate for the slight loss of luminous flux during a lamp's life with more current and hence greater output.

To ensure maximum stability of lamp operation, the output characteristic of the rectifier should cut the lamp characteristic at an angle of about 90° if possible.

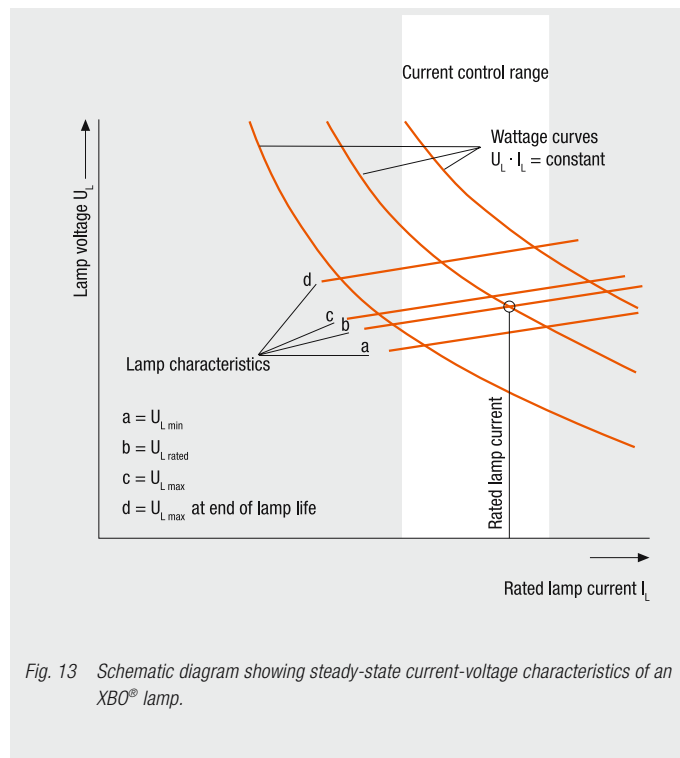

Ignition

When cold, XBO® lamps are outstanding insulators. Applying the lamp supply voltage of, say, 100V (the open circuit rectifier voltage) has no effect. To start the lamp, special measures are needed to make the insulating gas between the two electrodes conductive by ionizing it. This is normally done by means of a high-voltage discharge or flash. A number of boundary conditions must be met for a flash of this type to become a stable, steady arc, including:

- A sufficiently high peak voltage (ignition voltage) from the igniter
- An adequately long lasting ignition pulse
- Sufficient electrical energy in the ignition spark
- Current flow in the rectifier starting sufficiently quickly
- Adequate open circuit voltage in the rectifier

If the igniter **peak voltage** is not sufficient to bridge the electrode gap, there will be no discharge. If the ignition voltage is sufficient to obtain a discharge but there is not sufficient **energy in the ignition spark**, the spark goes out before the lamp can come near to its steady-state operating range and the rectifier can maintain the discharge. What happens in practice is that the lamp flashes briefly.

If the rectifier is unable to provide the required current quickly enough after the discharge, the lamp again goes out; the only difference from the previous case is that its flash may have lasted very slightly longer. To enable a smooth transition from spark discharge to stationary dc operation, the rectifier must fulfill minimum requirements in respect of its **open circuit voltage**. This is typically greater than the lamp voltage by a factor of 3 or 4.

Due to practical design considerations, the ignition voltage is normally generated in the form of a series of **high-frequency pulses**. If the pulses follow each other in rapid enough succession, at a frequency of 300 Hz for example, ignition of the lamp is facilitated by the fact that the conducting path between the electrodes generated by the first discharge is maintained and extended by the subsequent pulses.

Once the lamp has been ignited, the igniter should be switched off. Though relatively small, the ignition spark energy can still damage the electrodes over a long period of time. **Operating times** between 0.2 and 0.5 seconds are advisable for the igniter. In principle, XBO® lamps can be ignited with a single pulse. This method is favored more and more, firstly to reduce the otherwise jarring ignition noise, and secondly to minimize electromagnetic interference in surrounding electronic equipment. **Single-pulse igniters** require approximately 20 % higher peak voltages because they lack the supporting effect of the pulse chain.

The positive effect of the **ignition wire** has already been discussed in the section on “Lamp design” (q.v. page 10).

Startup

In steady-state operation, after a constant current has been established, XBO® lamps have a gently rising, positive current-voltage characteristic. The parameters of ignition – production of a discharge between the electrodes – are described in the previous section. Lamp behavior, immediately after the ignition spark has produced a conducting, ionizing path, is very complex.

If the lamp is regarded as an ohmic resistor (which of course it is not), the resistance falls after the ignition discharge within a very short time from infinity to a few tenths of an ohm. How it gets there, and that the lamp does not go out again after this dynamic and explosive process, depends on the characteristics of operating equipment (rectifier or ECG) and the cabling.

Figs. 14 and 15 show typical **inrush current curves** for the first 3 msec and 30 msec after the start.

It is important both for the path created by the ignition spark to be fed quickly enough with enough electrons to be kept alive, and for the still cold electrodes not to be damaged by excessive current levels.

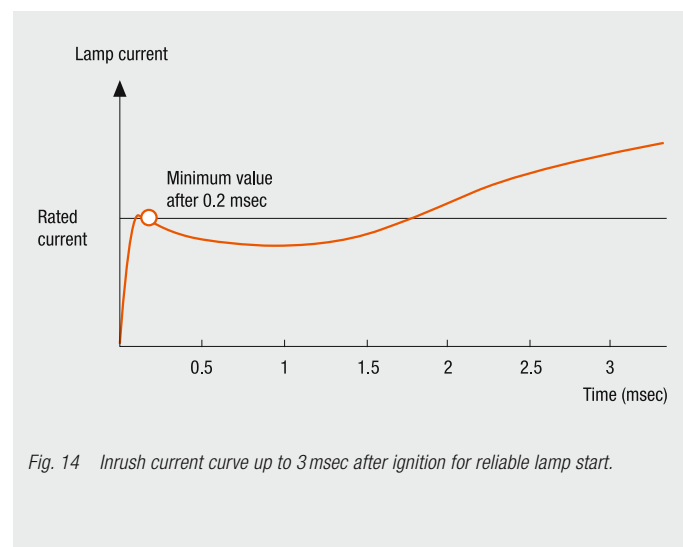

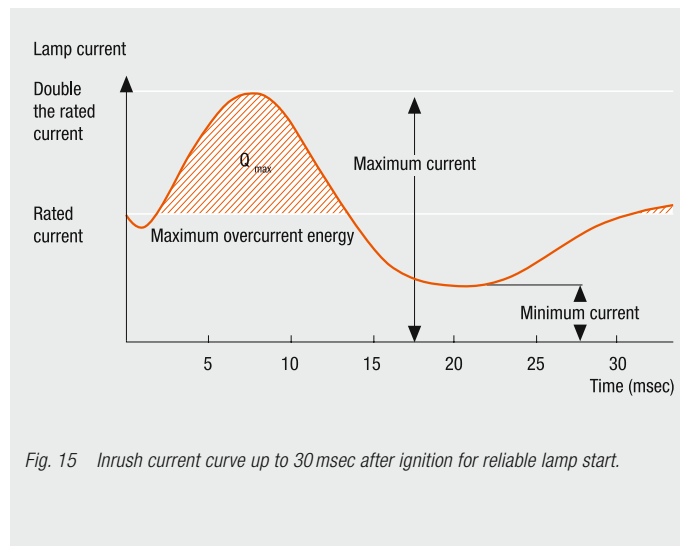

The following boundary conditions must be fulfilled for reliable arc formation:

1. The rated lamp current must be reached at least 0.2 msec after the discharge.
2. For a non-damaging start, the inrush current peak should not exceed twice the rated current, and in no case should it exceed the maximum peak value specified in the data sheet.
3. During the startup phase, the current must not fall to below half the rated current.
4. The total overcurrent energy (ampere-seconds) applied to the lamp in the first second must not be substantially more than 50 % above the rated value (i. e. rated current multiplied by time).

The first requirement can normally only be achieved with an **auxiliary ignition capacitor** connected in parallel with the lamp. To fulfill the second requirement, a suitably dimensioned series resistance must be installed in series with it. The third requirement means that the rectifier must deliver enough current to maintain the arc within the discharge time of the auxiliary ignition capacitor. Meeting the fourth requirement will protect the cathode.

Present-day ECG can be dimensioned so that hardly any overcurrent flows through the lamp, or even none at all. This behavior is clearly lamp-friendlier and results in a longer lamp life.

Current ripple

A basic requirement for operating XBO® lamps is direct current; in fact, direct current as supplied only by batteries. Direct current generated by rectification betrays its origins by a current ripple superimposed to a greater or lesser extent on the direct current. The quality of direct current is specified as a percentage of its residual ripple.

The term “**residual ripple**” must be more precisely defined. The “lamp current ripple p_i ” is a determining factor in the behavior of XBO® lamps and is defined as:

$$p_i = \frac{i_{\max} - i_{\min}}{i_{\max}} \cdot 100\%$$

where i_{\max} and i_{\min} are the maximum and minimum current over time (see Fig. 16).

This ripple must be as low as is technically feasible and economically viable. The lower the ripple, the better the long-term lamp behavior. Excessive ripple is the dominant factor in reducing lamp life. The following maximum permitted values are specified:

$P_i < 10\%$ for lamps up to 3,000 W

$P_i < 5\%$ for lamps of 3,000 W and higher

Fig. 31 on page 36 shows a cathode fissured after a long period of operation with excessive current ripple.

Lamp current ripple can be reduced by **smoothing elements** in the rectifier. Chokes can be used to a certain extent, but most of the smoothing effect must be produced by high-capacitance capacitors. These capacitors are subject to an aging process during which they lose their capacitance. Monitoring and measuring current ripple is therefore an important theme in trouble-free lamp operation.

A technically sound way of **measuring current ripple** is to use a low-induction shunt (series resistor of a tenth of an ohm or less) in the lamp circuit. The voltage drop at this shunt is analyzed with an oscilloscope and the ripple calculated using the formula given above.

It is important to record the actual current ripple. Measuring the voltage across the lamp or even the open circuit voltage of the rectifier can give completely false results. On the one hand, XBO® lamps act like reactive components with inductance and capacitance in the face of the alternating current component, and on the other hand, the steady-state characteristic (see page 16) is itself much flatter than with an ohmic resistance. The **voltage ripple** is therefore always markedly lower than the current ripple.

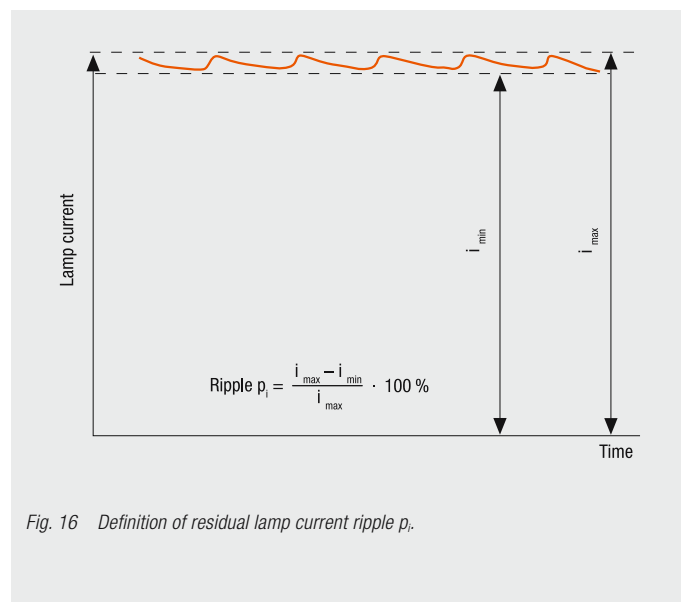

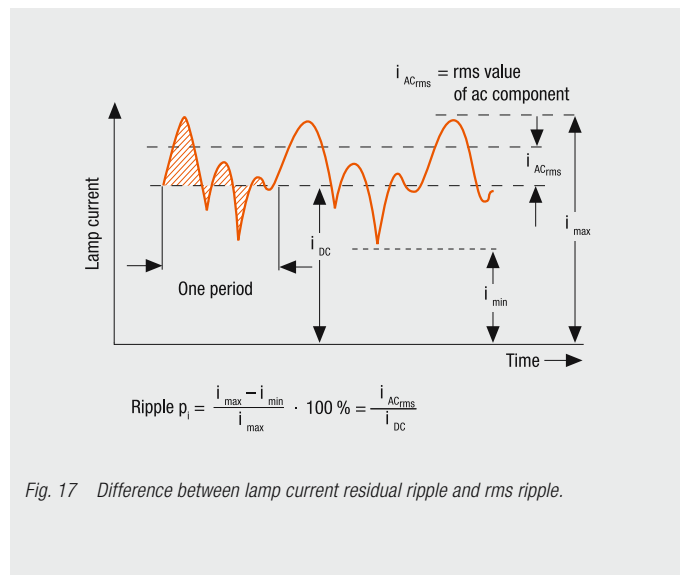

Fig. 17 Difference between lamp current residual ripple and rms ripple.

Users should also be warned against determining the alternating current component of the direct current with an **rms** instrument. The diminishing effect on lamp behavior is caused by the actual current peaks on top of the direct current, not by the rms value of the alternating current component. See Figs. 16 and 17 for clarification of the difference between rms value and instantaneous peak value. A difference of a factor of 10 is not unusual in ripple curves occurring in practice.

A better method is to estimate the ripple by means of the light. Using a fast enough photocell and an oscilloscope, it is possible to ascertain whether the ripple is in the correct order of magnitude by **measuring the light**, without using a great deal of equipment. With a ripple of between 5 and 10%, the light ripple is about 50% higher, as the luminous flux is proportional to the lamp current to the power of 1.5.

Present-day, well-dimensioned ECG can generate current with a very small residual ripple. Values clearly under 1% are the norm. This small residual ripple preserves the electrodes and results in maximum lamp life. Trouble-shooting of defect ECG can be problematic. As the electronics operate in the kilohertz range, the current ripple can also show very high frequencies. Measurements of the current ripple at high frequencies demand high-grade and fast measuring equipment and experience.

Operating equipment

Lamp housings

XBO® lamps are high-brilliance IR and UV light sources which generate a not inconsiderable amount of UV radiation and are under high internal pressure. For these three reasons, XBO® lamps must only be operated in closed housings.

These housings are designed to suit the particular application, whether film projection, video projection, spotlighting or solar simulation. They must all have the following features however:

Protection from **glare**: lamp housings must be designed so that the arc cannot be viewed directly. The brilliance of the arc is so high that it can destroy the retina.

Protection from IR and **UV radiation**: lamp housings must be so designed that radiation emitted by the lamp cannot leave the housing unfiltered either directly or in the form of scatter. This does not of course apply to luminaires designed expressly for the utilization of this kind of radiation.

Protection from **quartz glass splinters**: lamp housings must be designed so that if the lamp bursts in operation no quartz glass splinters can escape.

Sufficient space for fitting and removing lamps should be allowed to enable a lamp's **safety cover** to be removed at the last moment before closing the lamp housing.

Special attention should be paid to the **mechanical fixing** of lamps. They should be clamped in position at one end only in order to allow for expansion and distortion of the housing when it heats up as a result of operating the lamp. The other end must move freely. A soft, yielding support is necessary for fairly large lamps operated in the horizontal burning position.

It is useful to provide suitable holes and viewing plates for **obscuring the arc**, especially for lamps operated horizontally, in which case a magnet has to be placed in the correct position to stabilize the arc.

The **electrical design** must comply with current rules and safety requirements. A door contact (interlock) which completely interrupts the supply voltage on opening the lamp housing is useful. Allowance must be made for the high currents demanded by XBO® lamps and the high voltages of 10–60kV needed to ignite them. As the discharge arc can be slightly deflected by magnetic fields, it is necessary to ensure that it is not affected by any interference fields from the electrical wiring and components. This also applies of course to remanent fields from the actual lamp housing.

The highly concentrated output of XBO® lamps makes **cooling** essential. Suitably designed convection cooling will sometimes be adequate for large open lamp housings. Forced cooling is usually essential for close-packed appliances and very compact lamps. See the section on "Operating parameters: Cooling", page 28, for further details on cooling lamps.

Additional external extraction of air from the housing is often advisable to supplement the internal cooling. This is necessary for non-ozone-free lamps to prevent the operating personnel from being subjected to nuisance and hazard.

Rectifiers

As a rule, XBO® lamps are operated with rectifiers or ECG. Direct **battery** operation is also possible in principle, though there are problems with the often low battery voltage and the ability to regulate the current.

The general requirements which control gear must meet to render them suitable for operating XBO® lamps are described in the section on “Electrical characteristics” on page 16.

Rectifiers are manufactured for both single-phase and **multiphase** operation. In the latter case, the necessary smoothing of the lamp current is less complicated. Highly unbalanced three-phase networks can nevertheless give rise unnoticed to increased current ripple. Warning equipment must also be provided in order to prevent the lamp from being operated with excessive residual ripple if one phase fails.

Because the open circuit voltage level in conventional (i. e. non-electronic) rectifiers is a considerable factor in the cost, **booster** circuits are often used (see Fig. 18). The main current source is designed for continuous operation at the rated wattage but has an open circuit voltage markedly lower than the minimum requirement. The higher voltage needed only at the moment of ignition is supplied from an additional rectifier. For reasons connected with the dimensioning of electrical components, the booster open circuit voltage should be clearly greater than the minimum required for standard rectifiers.

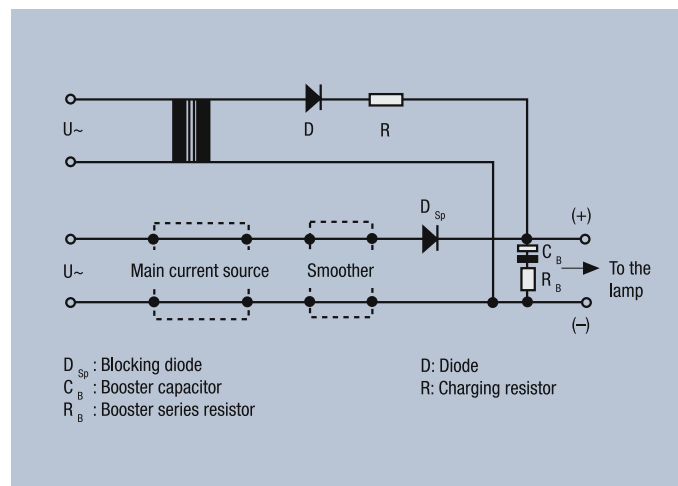

Fig. 18 Block diagram of a booster circuit.

Igniters

XBO® lamps require a high voltage to ignite them. Details are given in the section on “Electrical characteristics: Ignition” on page 17.

The most commonly used types of igniter are high-frequency superimposing igniters. Fig. 19 on page 24 shows a typical circuit of comprising rectifier, superimposing igniter and lamp. The high voltage is coupled into the lamp circuit by a tesla transformer. A component still important today for these igniters is a **spark gap** which operates as a high-voltage switch. It is subject to a certain amount of wear due to its design, and must therefore be either replaced or readjusted at regular intervals. If the electrode gap in the spark gap changes, both the level and the number of ignition pulses change too, usually for the worse.

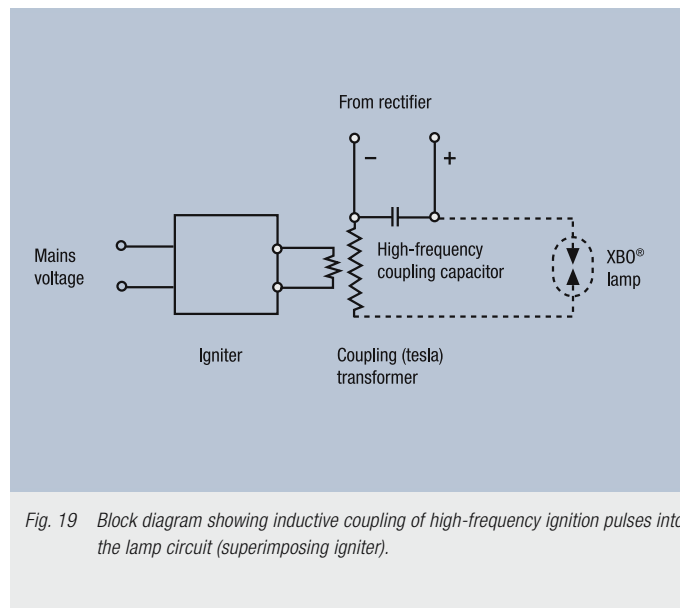

Fig. 19 Block diagram showing inductive coupling of high-frequency ignition pulses into the lamp circuit (superimposing igniter).

Modern igniters are fully electronic and do not suffer wear. They are often of the one-pulse ignition type and so particularly gentle in their effects on surrounding electronic equipment due to their reduced electromagnetic interference radiation.

All igniters should switch off automatically after the lamp has been ignited, in order not to damage the lamp. Minimum operating times should be about 0.2 seconds, maximum operating times about 0.5 seconds.

To minimize (high-frequency) high-voltage losses between igniter and lamp, the distance between these two units should be as small as possible, and never greater than 50 cm.

Operating parameters

Burning position

The first XBO® lamps were designed and suited solely for vertical operation. Only in this burning position could an arc of sufficient stability be achieved. A double reflector system consisting of an elliptical main reflector and a spherical auxiliary reflector were used for optimum utilization of the luminous flux. Not until 1970 were lamps successfully built in the horizontal position. This burning position enabled the use of lighting systems with deep-dish elliptical reflectors (already common for carbon arcs), which give an approximately 30 % increase in utilization factor. Fig. 20 shows schematic diagrams of the two types of system.

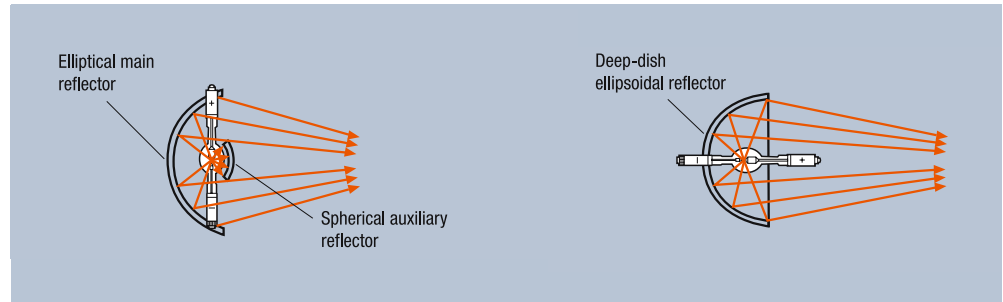

Fig. 20 Optical configuration of vertical and horizontal lamp housing for theater projectors.

From the functional point of view, the most favorable burning position for XBO® lamps is the **vertical burning position**, with the anode at the top. In this configuration, everything is rotationally symmetrical. The electrons emitted by the cathode firstly take gas particles with them, and secondly the widening out of the hot arc causes a gas jet in the direction of the anode. With the anode at the top, the convection forces exerted on the arc act in the same direction. The result is an arc that burns extremely smoothly and is stabilized by both electromagnetic and thermo-dynamic forces alike.

If a lamp is mounted in the reverse position with the anode at the bottom, the gas jet and convection forces work against one another with the result that the arc fidgets and the lamp is unusable because of arc instability.

Clearly, any amount of inclination of the lamp will inevitably disturb the stabilizing symmetry. The greater the tilt, the greater the disturbance. The **permitted tilt** for lamps designed to be operated vertically is typically limited to $\pm 30^\circ$.

In the **horizontal burning position**, the convection force acts perpendicularly to the direction of flow of the hot xenon gas; the gas is deflected upwards and burns half past the anode. This mode of operation was only made possible by introducing magnetic arc stabilization and by developing lamps with very short electrode gaps, high currents and a new bulb geometry.

The shorter the arc length for a given current, the more rigid is the arc and the less easily it can be deflected for example by convection.

After the vertical burning position, the horizontal has the next greatest number of factors of symmetry. Deviations from the horizontal, especially **tilting** downwards, will result in markedly greater arc instability (see Fig. 21 on page 26). Tilting the lamp with the anode at the bottom is the worst position. In this case, the convection forces act increasingly against the flow of the xenon gas and the instability of the arc worsens dramatically.

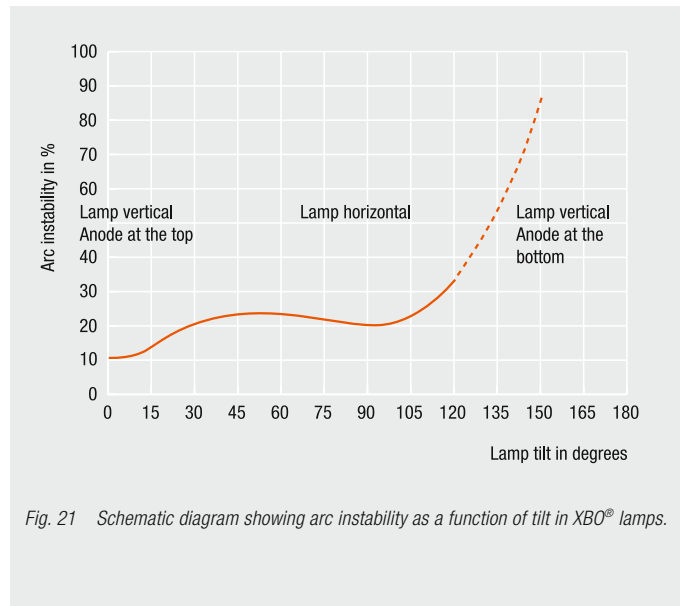

Where a fairly large degree of tilt downwards cannot be avoided, it is therefore necessary to consider turning the lamp round in the optical system so that the cathode is at the bottom. Depending on the layout of the optical system, this can sometimes result in a loss of usable light, but it also results in much better lamp behavior.

Every lamp designed for horizontal operation can usually also be operated vertically.

Magnetic arc stabilization

As described in the previous section, when lamps are operated horizontally, thermal convection acts on the arc perpendicularly to its direction of flow. Depending on the rigidity of the arc, it is deflected to a greater or lesser extent from the cathode-anode axis.

This deflection can be compensated for to a great extent by exploiting the fact that the gas stream is coupled to the electron flow. Electrons can be deflected by means of magnetic forces, so that a suitably installed magnetic field with a downward acting force component can almost completely eliminate the effect of convection.

The **size of the magnetic field** needed at the site of the arc is small and is only slightly greater than the magnetic field of the earth. In practice, this field can be generated with a small rod-shaped permanent magnet about 5 cm in length attached across the lamp axis if possible directly under the arc. Looking along the lamp from cathode to anode, the north pole must be on the right; otherwise the arc would be pushed upwards. If the magnet cannot be mounted directly under the lamp due to lack of space, it can also be moved forwards or backwards relative to the lamp axis.

Mounting the magnet beneath the lamp has two advantages. Firstly, it has been found that “pulling” the arc downwards gives more stable conditions than “pushing” it downwards. Secondly, heating of the magnet by the lamp can be better controlled. If the magnet reaches a temperature of about 600 °C (dependent on material), it can lose its magnetism.

It is essential to **adjust the magnetic field** to obtain correct compensation of the convection force. Its strength can be varied by altering the distance between magnet and arc; the nearer it is, the stronger the magnetic force. In some cases, an active magnet – an iron core surrounded by a coil through which a current is passed – is used. In these, the field strength can be changed very simply by adjusting the current. The most important factor in adjustment, however, is the ability to observe the shape and position of the arc.

A view of the horizontal position of the arc is the most important. A view from above is also advisable to be sure that the arc is not deflected across the axis by mistake because of a distorted magnetic field. It will generally be necessary to make suitable observation holes in the reflector and in the outer wall of the lamp housing.

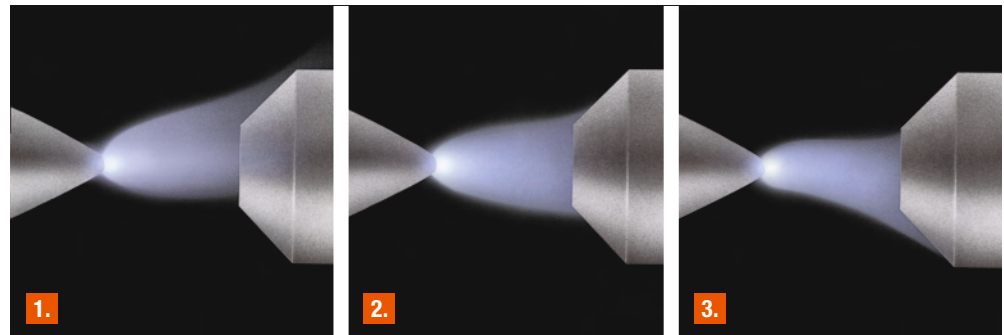

Fig. 22 Magnetic arc stabilization. Unstabilized (1.) Correctly stabilized (2.) Overstabilized (3.)

Fig. 22 shows how the shape of the arc changes when the magnetic field is adjusted. The aim is to make the arc hit the front face of the anode centrally. Fig. 35 on page 43 shows a typically deformed anode with a nose-shaped growth such as can occur in long-term operation without magnetic stabilization or with it incorrectly adjusted.

Magnetic stabilization is not required for some types of horizontal lamp with a stiff enough arc to ensure adequate lamp behavior throughout their life. Though the behavior of these lamps too can be further improved with optimally adjusted magnetic stabilization, in this case the principle that no magnetic stabilization is better than poorly adjusted stabilization applies.

Turning the lamp

When the horizontal burning position was introduced in the Seventies of the last century, bulb blackening was the life-limiting phenomenon for XBO® lamps. Due to the horizontal burning position, deposition in the bulb did no longer occur in the shadowed region behind the anode but in the upper region, the relevant area in sight. The result was, on the one hand, a reduction of the luminous flux and, on the other hand, strong bulb heating of the blackened region due to absorption of radiation.

The recommendation to turn the lamp by 180° along the lamp axis after half the lamp life stems from this time period. This made the distribution of the blackening more uniform and local overheating was prevented.

Present-day electrode materials have been improved in such a way that blackening does no longer occur under normal conditions. Turning the lamp during lamp life is no longer necessary.

The life-limiting phenomenon of today's lamps is usually arc instability. With regard to this matter, turning the lamp can even have unfavorable influence. Because of the turning, the arc at the cathode must begin at a new point. This can temporarily, for some lamps also permanently, increase arc instability.

Cooling

Some types of XBO® lamp manage without forced cooling, especially when they are operated in large open lamp housings and a chimney effect is achieved through good design. In other types of lamp, however, the output is so highly concentrated that forced cooling of the base connection parts and sometimes also of the quartz glass bulb is essential.

Cooling is done with air. The cooling air stream, generated with fans, should be as cylindrical as possible along the lamp axis. In horizontal theater lamp housings, in which the cathode end of the lamp is inserted into the reflector, the cooling air is normally blown from here towards the anode. Blowing is better than extraction because it is very simple to create an air stream with a defined flow. In vertical lamps, cooling from the hot anode end at the top is better overall as the bulb is cooled by air that has already been prewarmed, so reducing possible turbulence in the lamp's interior.

The first criterion of adequate cooling is **base temperature**. This must not exceed 230 °C. Stick-on temperature sensors or thermally sensitive paint can be used for measurement. The temperature limits must not be exceeded even in worst-case conditions such as high ambient temperature or contaminated filters in the cooling air stream. Sometimes a cooling air stream directed specifically at the base is useful.

For those lamp types which require **bulb cooling**, the air speed at the lamp's equator, 5 mm above the surface, should be about 5–8 m/sec. This is measured with a commercially available anemometer. It is not advisable to measure the bulb temperature, firstly because at 600–900 °C it is very high, and secondly because the lamp housing must be opened with the lamp lit to perform the measurement which is at least potentially dangerous because of UV radiation and the risk of bursting. Blowing air on the bulb on one side only must be avoided because this generates additional stresses in the quartz glass and unbalances the inner convection symmetry, resulting in turbulence. The consequences of this would be an unstable arc and risk of bursting.

Excessive cooling is not good because it too can bring about increased arc instability due to turbulence in the lamp bulb. If the lamp voltage with cooling falls by more than 1 volt compared with uncooled operation, this normally means that cooling is excessive.

Some types of lamp are supplied with special **cooling air funnels** for the bases. These are designed to direct part of the air stream into the interior of the base. Care is needed to mount the funnels correctly, as this depends on the direction of the cooling air stream. Both the direction of the opening and the size of the two funnels must be carefully noted (see Fig. 23).

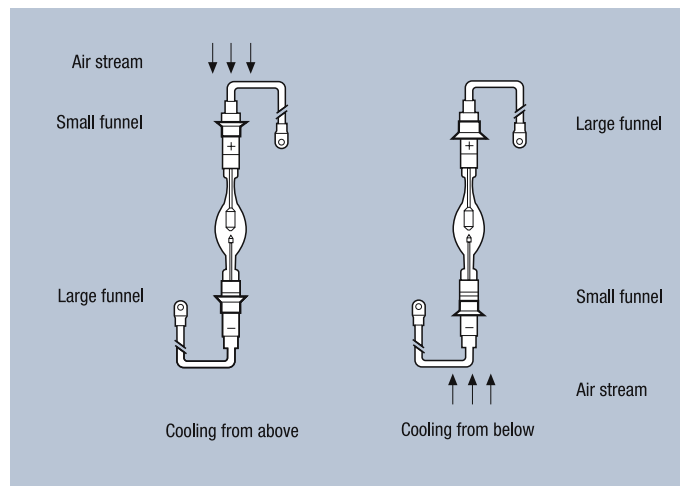

Fig. 23 Correct mounting of cooling air funnels with a cooling air stream from above or below.

In addition to the internal cooling cycle, an adequately dimensioned external extraction system for the entire lamp housing has proved to be a good solution in many cases. Extraction of the air from the lamp housing into the open air is mandatory for non-ozone-free lamps to protect against ozone damage. Fig. 24 is a schematic diagram depicting this arrangement.

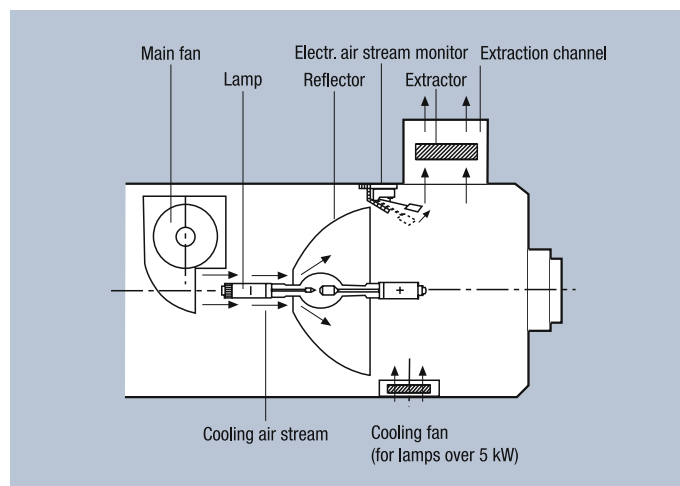

Fig. 24 Schematic cross-sectional sketch of a typical cooling system in a theater lamp housing with internal fan and external extraction.

Current control range

By far the majority of XBO® lamps have a current control range. This is a range round about the rated current in which the lamps may be operated in order to adapt to the individual requirements of the application. More current means more light, but also usually shorter life as a result of greater load on the electrodes.

The best results in terms of lamp life are usually obtained by operating the lamp initially at slightly less than its rated current and then taking it to the maximum by the end of its period of use. The main purpose of the current control range is to compensate for the slight loss of light due to blackening as the lamp ages. It is not advisable to operate lamps continuously at **minimum current**. The expected increase in lamp life often does not take place as the arc is constricted at the cathode, makes a small area hotter and so offsets possible gains in lamp life with increased blackening. If a lamp is operated at minimum wattage because it is too bright, it is usually advisable to use a lamp with the next lower wattage.

As a rule, it is also inadvisable to operate lamps continuously at **maximum current**. This always reduces lamp life compared with operation at the rated current. Where this type of operation cannot be avoided, users must also check whether a lamp with the next higher wattage would be worthwhile.

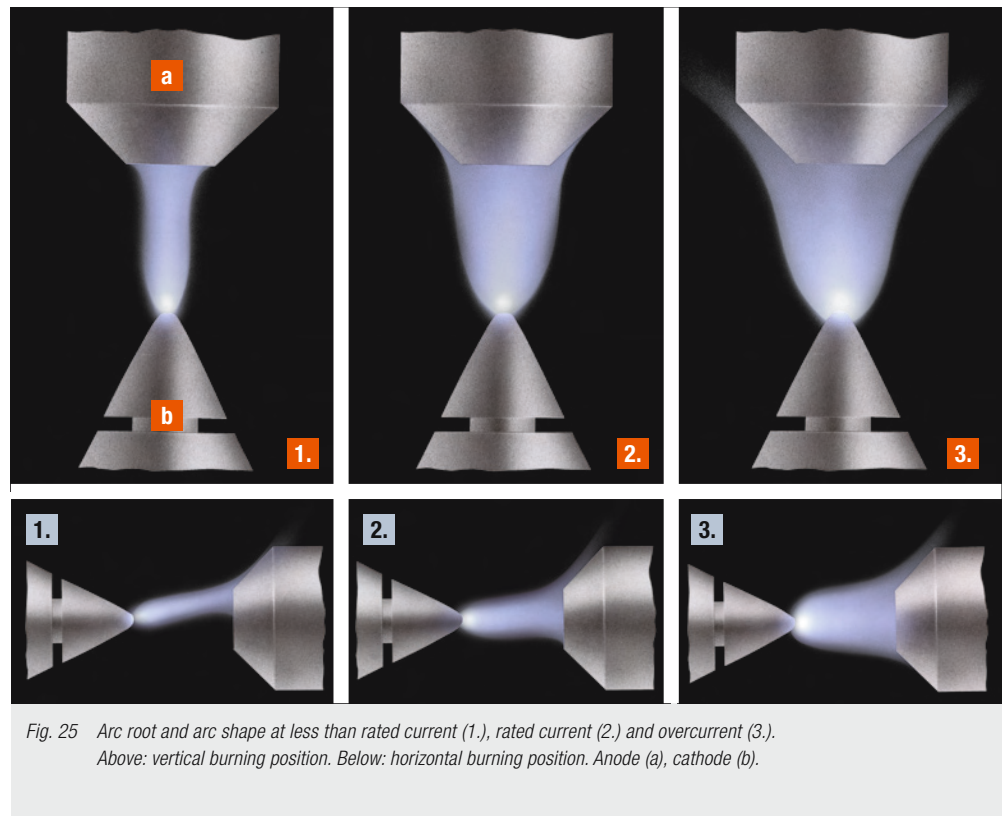

Fig. 25 is a schematic diagram showing the change in **arc shape** and arc root at the cathode at different currents with the lamp operated vertically and horizontally.

There is frequently a requirement, during intervals for example, to operate a lamp with a **standby current** in order to economize on power, to reduce heating of the equipment, to avoid sound interferences during ignition and to increase lamp life. Taking into account the above reasons, standby operation is basically useful provided the current is not reduced to below the current control range minimum. It is not advisable to operate a lamp at lower currents between the minimum current and the lower limit for a fairly long time, as in most cases negative effects on the electrodes would more than offset any hoped for advantage.

Operating duty cycle

XBO® lamps are optimized for their respective applications. Differences in design lead to differences concerning the operating duty cycle. Lamps for conventional film projection are optimized for an average operating duty cycle of 90 minutes, thus achieving their maximum life. For video projection, effect lighting applications or solar simulation, the lamps are optimized for longer cycle times. If the lamp is not in use for a short break, it is generally recommendable to keep the lamp burning if the break is not longer than 10 minutes. Lamps with extremely short arcs, which are common in video projection, may suffer from overloading of the anode if permanently operated. In this case, the lamp life can be extended considerably if the lamp is allowed a cooling phase after some hours.

Ignitions do also not extend the life of XBO® lamps but they damage them clearly less than lamps filled with mercury. During the ignition phase, mercury lamps operate in the low-pressure range, while XBO® lamps can start cold at a gas pressure of 5–15 bar. The high pressure allows an easier startup of the XBO® cathode.

Lamp behavior

Lamp life

The average life of XBO® lamps means the operating period after which half the lamps from a not too small number of a given type no longer have to comply with the specified data. For the lamps under consideration, this means that they are allowed to show a **reduction in luminous flux** of 30 % after this time.

It is assumed that the lamps are operated with the correct equipment (rectifier, igniter and lamp housing) and according to specification (current, burning position, switching cycle).

The main factors that reduce lamp life are:

- Overcurrent
- Undercurrent
- Operating duty cycle (type-specific)
- High inrush current
- High current ripple
- Unfavorable burning position, tilt
- Incorrect or inadequate magnetic arc stabilization
- Inadequate cooling

XBO® lamps can normally be operated beyond the average hours burned, provided they are still sufficient for the application. They should, however, be replaced after exceeding this time by 25 %. After this time, even if blackening is still at an acceptable level, the quartz glass has usually recrystallized to such an extent that there is a considerably increased risk of bursting. Recrystallization means that the structure of the quartz glass changes from the glass phase into the crystalline phase under the influence of the high bulb temperature and the temperature cycle. This initially causes the quartz glass to lose its strength; at an advanced stage, it also becomes opaque.

This factor is becoming increasingly important as a result of the fact that fundamental developments in tungsten metallurgy are suppressing blackening to an ever greater extent. See also the next section.

Blackening

XBO® bulbs blacken over lamp life. This is caused by tungsten gradually vaporizing from the electrodes and being deposited on the “cooler” bulb. The vaporized tungsten is deposited in the place to which it is carried by the internal gas flow. In vertical lamps, this is usually the dark region behind the anode, which means that bulb blackening has virtually no effect on the luminous flux emitted by the lamp. The situation is different in horizontal lamps, where material vaporized from the electrodes is carried by the gas jet from cathode to anode and by the convection current directly to the upper part of the belly of the bulb.

Blackening has the disadvantage that it **reduces light** and also increases the amount by which the quartz glass heats up due to the absorption of radiation.

As blackening originates from the electrodes, their characteristics and condition are crucially important. Electrode life, especially the life of the anode, has been considerably improved by OSRAM in recent years by fundamental developments in metallurgy.

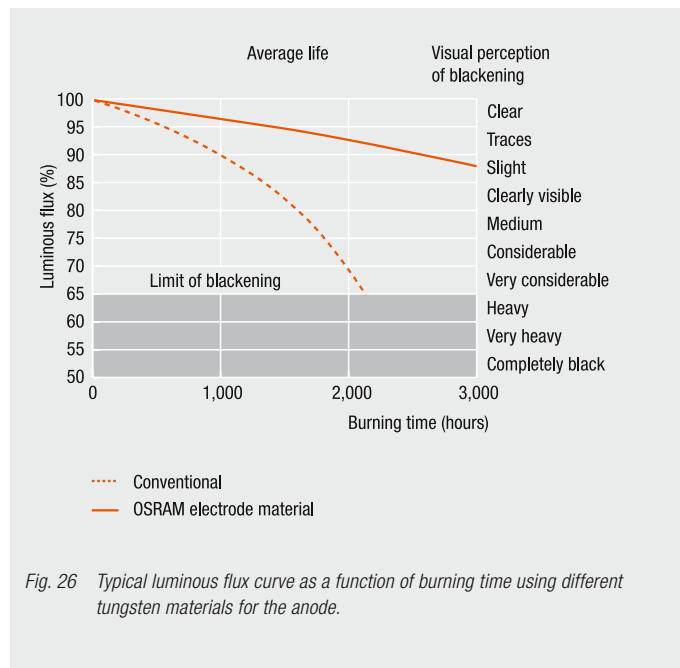

Fig. 26 shows an example of what has been achieved. The main key to this, besides the composition and density of the material, is control of the **structure of tungsten metal**. The size, shape and orientation of the microscopically small crystallites determine the macroscopic behavior of an anode during its life (see Fig. 27). A geometry that stays the same ensures little blackening.

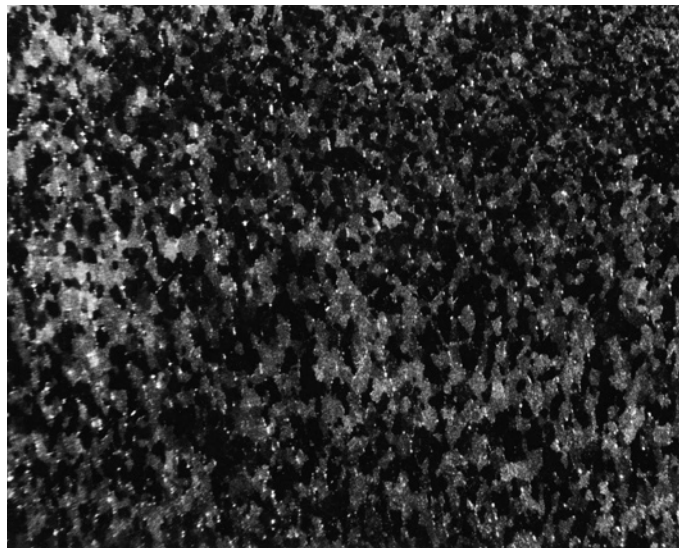

Fig. 27 Grain structure of the tungsten material near the surface of an anode.

Little blackening, which becomes visible after half the lamp life and increases continuously, is normal.

Sudden **complete blackening** of the bulb, sometimes accompanied by deep blue or light yellow coatings, is a fault and indicates that air has penetrated the lamp. Another cause of immediate blackening can be incorrect polarity. In this case, the narrow cathode takes the thermal load of the anode; within seconds its tip melts to a round shape (see Fig. 34 on page 40), the vaporization products are on the bulb wall and the lamp has become irreversibly unusable.

The speed at which normal blackening takes place depends on a large number of factors. The process is accelerated by the following operating parameters:

Overcurrent: This makes the anode and cathode hotter and causes them to vaporize more quickly. In severe cases, the electrode surface may erode, causing heavy local overheating which further accelerates the blackening process.

Undercurrent: This causes the arc to constrict at the cathode tip, resulting in local overheating of the cathode surface and consequently increased vaporization.

Residual lamp current ripple: The higher this is, the more rapidly the cathode surface becomes fissured and the front face of the anode deformed. The arc then prefers to start at the peaks and highest points, which become especially hot because of reduced heat conduction in the electrode body. In severe cases, a lake of tungsten may even form. Excessive residual ripple is the main factor in fissuring of electrodes.

Peak inrush current: When the lamp is ignited, the cathode, still in its cold state and reluctant to emit electrons, has to deliver the high inrush current. Especially if this is above the permitted level (see section on “Electrical characteristics: Startup” on page 18), small, very hot arc roots accumulate which lead to local fusings of the cathode material. If more energy is added, the fused material evaporates explosively and can also shoot fusion pearls to the anode.

Arc stability and flicker

The discharge arc in XBO® lamps is mainly electrode-stabilized. This means that its position and shape are substantially determined by the position and geometry of the anode and cathode. Added to this static mechanical fixing is intrinsic stabilization by electromagnetic and dynamic gas forces. The electron stream produces a force acting in the direction of its axis, and the thermodynamic forces of the hot gas jet in the surrounding cooler xenon gas act in the same way. Taken in their entirety, these phenomena make XBO® discharge lamps burn very stably and are the main reasons why they are used as light sources in projection systems.

Nevertheless, the arc is not completely stationary. The tail of the arc in particular is subject to slight fluctuations caused for example by gas turbulence in the lamp (see Fig. 28, page 34). Emission conditions at the cathode tip can also change resulting in the root of the arc moving.

A definition or method of measurement is necessary to assess arc stability or instability.

Two-chamber brilliance method:

An image of the arc is projected through a lens onto two photodetectors separated optically from each other by an opaque partition (see Fig. 29, page 34). The differential signal is analyzed electrically. To start the measurement, the differential signal is zeroed by adjusting the image through the two chambers; this means that each photodiode sees exactly half of the arc, divided along its axis. If the arc moves at the cathode tip or its tail wanders during the measuring time, a signal not equal to zero is produced because one photocell chamber is receiving more light than the other. To determine arc instability quantitatively, the maximum measured signal is related to the signal that occurs when a complete image of the arc is projected onto a single photodiode. This method enables highly reproducible determination of spatial arc stability. It has the advantage that luminous flux or brilliance fluctuations of electrical origin – caused for example by current ripple from the rectifier – do not affect the result.

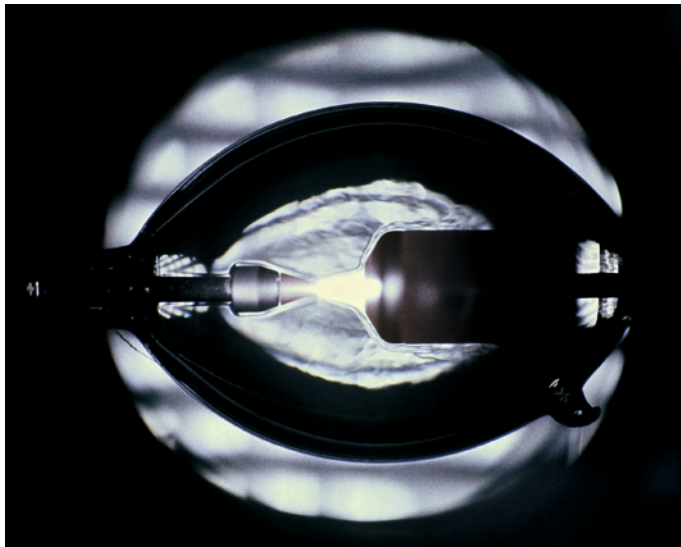

Fig. 28 Schlieren photograph of the gas stream in a burning lamp.

The top diagram in Fig. 30 shows the actual course of arc deflections over time, the bottom diagram the change in arc instability (within a fixed interval) during the hours burned and a statistical evaluation of the same.

As well as this very expensive measurement procedure, other less expensive methods have been documented, such as measuring the fluctuation over time of the luminous intensity or of the hot spot (the area of maximum brilliance in front of the cathode).

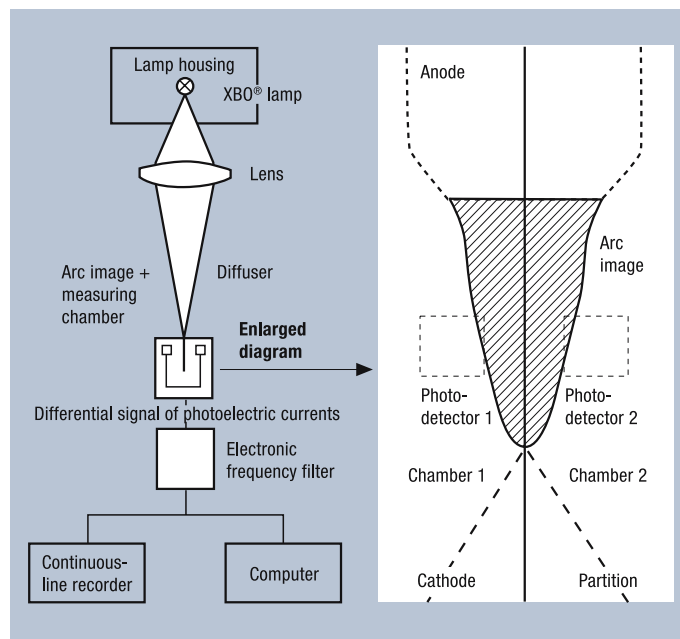
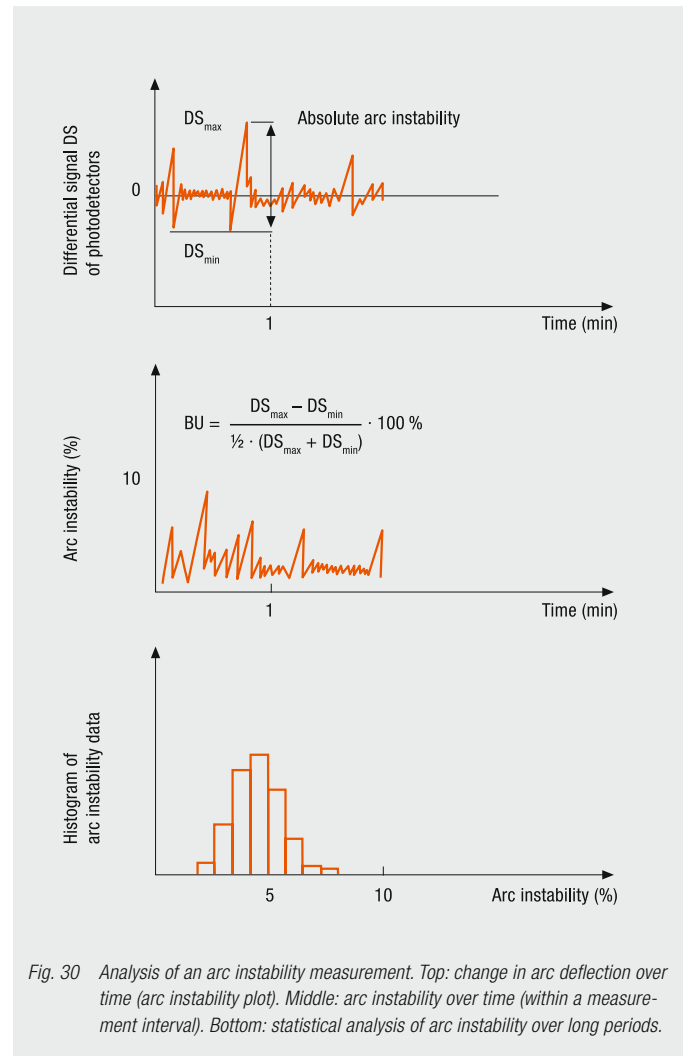

Fig. 29 Schematic diagram of the two-chamber brilliance method of measuring arc instability.

All the methods, however, have the flaw that the particular arc instability being measured may not necessarily be crucial to the application. Practically all XBO® lamps are used in optical systems (projectors or spotlights or light guides), and all optical systems respond differently to the different components of arc instability, irrespective of individual lamp adjustment. General statements, however, can only be made on the basis of a standard measuring method.

To analyze the effects of arc instability, cathodic and anodic instability must be separated.

Cathodic instability is present if the arc root is not stationary at the cathode tip but wanders, jumps or changes its shape. This type of instability is mainly determined by the condition of the cathode material and its surface. **Anodic instability** is caused by the tail of the arc fluttering; it is mainly a function of gas flow and turbulence, but is also affected by the geometry of the front face of the anode.



Lamp-related arc instability is affected by the following factors:

Lamp current: The higher the lamp current, the more rigid and stable the arc, and the softer and larger the root of the arc at the cathode. The cathode becomes hotter overall. The lower the current, the more constricted the arc root at the cathode; local overheating occurs, causing local partial depletion of emitter material and fissuring of the surface. The result is that the arc jumps about restlessly, trying to find the best emission conditions. Fig. 25 on page 30 shows arc shape as a function of lamp current.

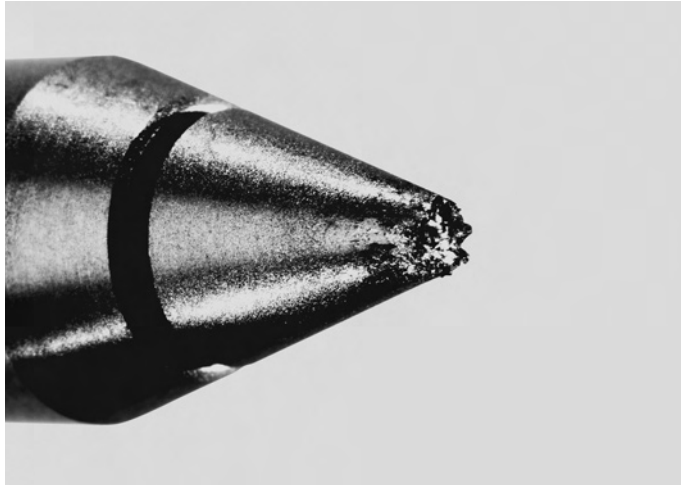

Fig. 31 Fissuring of the cathode tip as a result of excessive current ripple.

Residual lamp current ripple: This is an effect over time. High residual ripple leads to fissuring of the cathode tip (see Fig. 31) and, if it continues, also to distortion of the anode surface. Excessive ripple values can be regarded as the most important cause of inadequate arc stability.

Inrush current: Excessive inrush current peaks combined with frequent switching of the lamp erode the cathode tip, with consequent cathodic arc instability.

Bulb cooling: Excessive forced bulb cooling increases the temperature gradient between arc and bulb wall, resulting in greater radial gas flow and turbulence which mainly affect the tail of the arc.

Startup time: Increased arc instability is observed shortly after igniting the lamp, when all the components except for the arc are still cold. This is mainly caused by turbulence in the anodic region, but also in the cathodic region before the cathode has reached its operating temperature. This effect passes after a few minutes of burn-in time.

Burning position: The optimum burning position for arc stability is vertical with the anode at the top. Arc instability increases with tilt (some lamps have a level maximum at about 45). Tilting the lamp further beyond the horizontal, so that the anode is more and more underneath, increases arc instability dramatically (see Fig. 21 on page 26).

Lamp life: Even under optimum operating conditions, the cathode and anode geometry and structure undergo changes that lead to a gradual increase in arc instability.

In contrast to arc instability which is determined by the lamp, **flicker** is defined as a sudden change in useful light over time, occurring in the application. In theater projection systems, for example, it would be instability of the light reflected from the theater screen. As has been described above, different optical systems respond with greatly differing sensitivity to existing arc instability. Measures taken by users can often magnify or reduce this application-related instability.

We shall take a look at two examples:

Defocussing: Most optical systems for XBO® lamps use the stable maximum brilliance in front of the cathode. Light from the relatively unstable tail of the arc usually contributes very little to the useful luminous flux (see also “Brilliance distribution in the arc”, Fig. 7, page 11). If, however, the optical system is defocussed so that the useful luminous flux also – or mainly – comes from the tail of the arc, flicker may result. This often occurs in theater projection systems when there is a change of format (see Fig. 32).

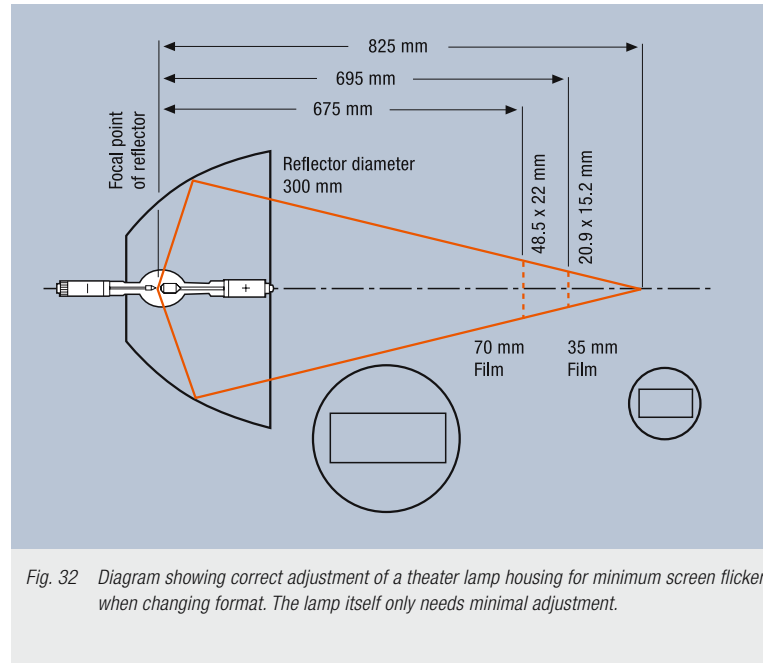

When changing from standard format to Cinemascope, or another large film gate, the correct procedure is to change the mounting distance, i. e. the distance from reflector to picture gate. If instead the easier option of only readjusting the lamp in the reflector is taken, it is still possible to illuminate the larger format adequately, but then areas of the arc remote from the cathode form part of the useful luminous flux, resulting in increased flicker.

Burn-in time: Shortly after XBO® lamps have been ignited, they undergo a period of increased arc instability because of the as yet unstable thermal balance. This period passes in a few minutes. Flicker effects can often be eliminated by allowing a short burn-in period before the actual period of use.

Generation of ozone

An electric discharge in xenon gas generates a spectrum ranging from about 140nm in the UV region to far into the infrared region. If the quartz glass bulb is transparent between at least 180 and 220nm in the UV region, this radiation converts a small proportion of the atmospheric oxygen (O_2) into ozone (O_3). Ozone is itself a colorless, odorless gas (what you can smell are the reaction products of ozone as it attacks air-borne pollutants and nitrogen compounds); it is extremely aggressive and will damage your lungs if inhaled at relatively high concentrations over a long period of time.

Ozone emission can be suppressed by using quartz glass which absorbs radiation in the relevant UV region. The result is “ozone-free” lamps, which have the letters “**OFR**” added to their lamp designation. The quartz glass used is either bulk doped or coated. See the UV radiation output in Fig. 33.

Occasionally, even “ozone-free” lamps give off an “ozone scent” shortly after ignition. This has two possible causes: the ozone is produced either as a result of the (temporary) radiation of the spark gap used for ignition, or from the fact that when the quartz bulb is in the cold state, the absorption edge can shift and small amounts of ozone-producing radiation can leave the bulb. Both effects are harmless and cease once the lamp has started up.

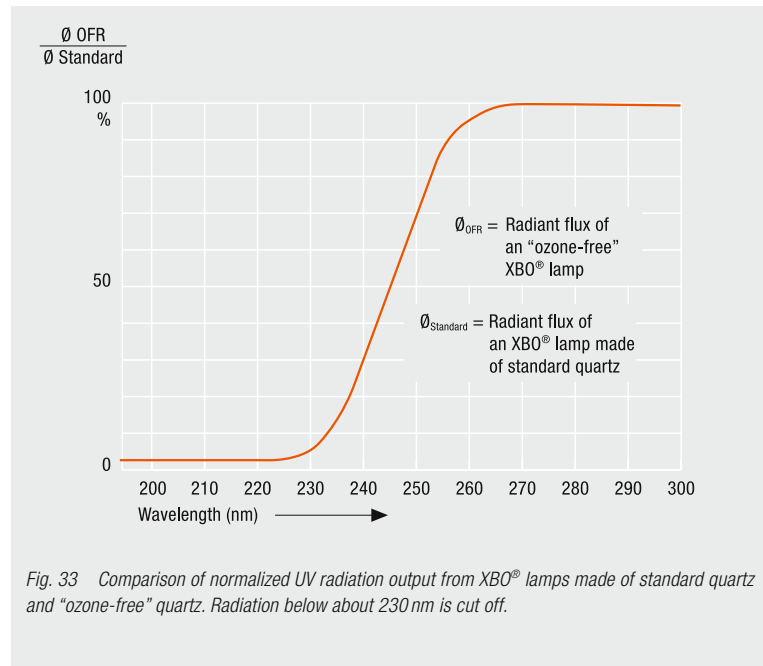

Handling

Mechanical installation

XBO® lamps are extremely robust. They must withstand the mechanical stresses exerted by their heavy electrodes, especially the anode which can weigh up to 800g, and the high internal pressure of up to 60 bar, or even more in low-wattage lamps. But they are still made of glass and need to be handled accordingly; in other words, they must be protected against shock, impact and excessive force. Certain precautions must therefore be observed when handling them.

All XBO® lamps are supplied in a **safety cover**. This protects users from bursting of the lamp. There is enough energy stored in the lamp bulb to send quartz splinters flying several meters across a room.

When the lamp is installed, its safety cover must not be removed until after it has been fitted in the lamp housing and shortly before the housing is closed. It goes without saying that you should wear leather gauntlets and protective goggles or complete face protection covering the arteries and veins of your neck, such as a transparent plastic mask.

Under no circumstances must force be exerted on the lamp during installation. For example, screwing in the cathode base by holding and turning the lamp at its anode base is grossly negligent.

The lamp may only be clamped in position at one end, in order to allow for expansion and distortion of the housing. Small (short) lamps can be left free and unsupported at the other end. Larger (longer) lamps must have a soft, flexible support, which calls for a mechanical solution. It should support the lamp but allow unrestricted expansion, including expansion perpendicular to the lamp axis.

If the lamp is inadvertently operated inside its safety cover, the sleeve will melt within a few seconds and the lamp will be unusable.

When removing lamps, the reverse procedure must be followed: first put the safety cover round the lamp, then remove the lamp.

Electrical connection

Similar precautions must be observed for connecting XBO® lamps electrically as for handling them mechanically.

Lamps without a cable connection often have their “loose” end connected to the supply unit with a gripping device. In these cases, the gripping device must be fastened first and only then can the lamp be fixed in its permanent connection, even if this is somewhat complicated. Otherwise there is a risk of unintentionally exerting strong bending forces on the lamp under which it may break.

The lamp must be connected electrically by means of the base components provided for this purpose, for example the base pins or cables. Under no circumstances must the cable be cut and the power supply connection passed through the base sleeve. This can result in an impermissible circuit and possible destruction of the lamp.

All electrical connections must fulfill the criteria for high-current connections. Connecting components must be clean and offer the maximum contact area. In cases of doubt, it is better to recondition or preferably replace the contacts rather than risk lamp failure due to corroded and overheated contacts. In most cases, good electrical contact is synonymous with good thermal contact to dissipate the heat produced by the lamp. Nickel or chrome-plated brass or bronze are the main materials used; other metals such as aluminum are unsuitable.

Care must be taken to ensure that the lamp is connected with correct polarity; the positive pole of the rectifier must be connected to the base marked "+", the negative pole to the base marked "-". Incorrect polarity results in total lamp failure within split seconds; the cathode fuses over immediately as a result of being overloaded as the anode.

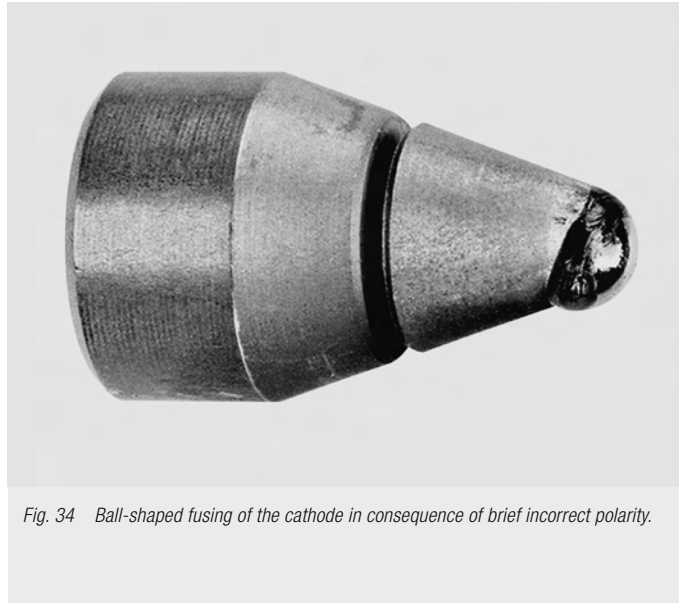

Fig. 34 Ball-shaped fusing of the cathode in consequence of brief incorrect polarity.

The relevant insulation gaps must be observed when installing the parts that conduct high voltage from the igniter to the lamp (protection against flashover and capacitive RF losses against ground).

Cleaning of lamps

XBO® lamps may only be held by the base. If the quartz bulb or the shafts should ever be inadvertently touched with bare fingers (which should never happen because unprotected lamps should only ever be handled with leather gloves), the fingerprints must be removed immediately. A lint-free cloth moistened with spirit is best for this, after which the lamp should be rubbed dry, taking care not to scratch the quartz glass surface. Damage to the glass may cause the lamp to break during later operation.

If fingerprints are not removed, they burn into the quartz glass surface where they act as a seed for ever-expanding recrystallization of the glass. This causes the glass to lose its strength and increases the risk of bursting.

Transport

XBO® lamps are supplied in transport boxes. In this condition, lamps can be sent through the post without any problem. The cushioning is designed so that the lamps cannot be damaged even by severe transport conditions and mechanical vibration.

If XBO® lamp housings have to be transported, the lamps – especially high-wattage lamps – should be removed and transported separately in their original packaging.

Storage

XBO® lamps can be stored indefinitely, as far as can be determined for a product only 50 years on the market. The ambient conditions, however, must be non-aggressive, for example, no storage temperatures over 50 °C, no condensation, and a non-corrosive atmosphere. In these circumstances, the material properties of quartz glass and tungsten change so slowly that no aging effects are evident. Where storage effects do occur, they usually affect external lamp parts such as the interiors of bases, the bases themselves and the power leads.

Disposal

Burnt-out XBO® lamps can either be returned to the manufacturer for appropriate disposal by methods consistent with modern recycling, if possible in the original transport packaging or in that of the replacement lamp, or they can be destroyed by the user.

Observing all the precautions given in the section on “Mechanical installation” on page 39, it is advisable to wrap the lamps up in the safety cover and to seal the ends tightly with the enclosed hook-and-loop strips. The hook-and-loop strips have to press the fleece tightly onto the lamp bases. The lamps can then be discharged safely by free fall from an height of about 1–2 meters onto solid ground (put on safety goggles and protective clothing!). The xenon gas that escapes is not poisonous and returns to the atmosphere from where it came. The remains of the lamp can be disposed of as rubbish and the electrodes and rods (i. e. tungsten material) sent for recycling.

**Problems – trouble-
shooting – tips**
Lamp does not ignite

The following parameters are important for igniting XBO® lamps:

- Level of high voltage applied by the igniter
- Number of ignition pulses per unit time
- Energy contained in an ignition pulse
- Level of rectifier open circuit voltage

If the lamp ignites poorly or not at all the following checks should be carried out:

- Is the ignition spark gap operating (auditory and visual check)?
- Is the electrode gap in the spark gap correct?
- Is the high voltage in the path from the igniter to the lamp lost through partial discharge?
- Is the lead between igniter and lamp as short as possible to prevent capacitive losses?
- Does the auxiliary ignition capacitor still have its specified capacitance (aging)?
- Is the series resistance in series with the auxiliary ignition capacitor correctly dimensioned?
- Is the ignition wire correctly attached?
- Does the rectifier deliver the minimum supply voltage?
- Has the lamp reached the end of its life?
- Is a lamp fitted?
- Is the power lead interrupted?

Flicker

Flickering of the useful light may result from a faulty lamp, unsuitable operating equipment or impermissible operating mode. Please read the section on “Lamp behavior: Arc stability and flicker” on page 33.

If flicker effects are observed after installing a new lamp, the following must be checked:

- Has the lamp burned in for long enough to obtain thermal stabilization (5–10 minutes)?
- Is the lamp being operated at the correct rated current?
- If a magnet is used to stabilize the arc, is it correctly set (visual check in two planes)?
- Is the correct type of lamp for the lamp housing being used?
- Is the lamp correctly adjusted in the optical system (in the reflector)?
- Is the distance between reflector and picture gate suitable for the film format?
(See Fig. 32, page 37.)

If flicker effects are observed during the course of a lamp's life, the following must be checked:

- Is the cathode tip fissured and have growths developed on the anode?
If yes:
 - Does the current ripple comply with requirements?
 - Is the maximum inrush current peak observed?
 - Is the magnetic arc stabilization system (if specified and used) correctly set up?
 - Is the lamp being operated in a permitted burning position?
 - Is the lamp being operated inside the permitted current control range?
 - Is the lamp being too heavily or asymmetrically cooled?
- Is the lamp correctly adjusted in the optical system (in the reflector)?
- Is the distance between reflector and picture gate suitable for the film format?
(See Fig. 32, page 37.)

Short lamp life

XBO® lamps normally reach the end of their life through aging of the electrodes and the consequent arc instability. Less frequently, non-ignition and blackening cause the end of their life. If the end of lamp life is reached too early, the respective sections provide help for trouble-shooting. In all cases of short life, the electrical data of the operating equipment and the operating conditions of the lamp must be carefully checked before a new lamp is fitted.

Incorrect polarity

XBO® lamps are purely direct current lamps. This means among other things that the cathode and anode are specifically designed for their particular tasks. Because of this specialization, the lamps may not be operated with reversed polarity. If this should inadvertently occur, the cathode becomes fused over within split seconds (see Fig. 34, page 40), making the lamp unusable. Lamps connected with incorrect polarity usually go out by themselves after ignition.

Deformed electrodes

The material structure and the shape of XBO® lamp electrodes are carefully suited to their respective tasks. During the course of a lamp's life, changes varying from slight to clearly visible occur in the electrode surfaces and geometry, even if the lamp has been correctly operated throughout. Large changes are frequently a symptom of faults, either in the electrode material (extremely rare), in the mode of operation (rare) or in the electrical operating conditions (frequent). Experienced technicians can obtain important information about the causes of faults from the type and extent of the changes.

A spherical cathode tip (Fig. 34, page 40) is easy to diagnose as incorrect polarity. Fig. 31, page 36, shows a cathode tip fissured as a result of increased current ripple. Fig. 35 shows the front face of an anode whose growth was caused by a lop-sided arc in horizontal operation (incorrect magnetic stabilization).

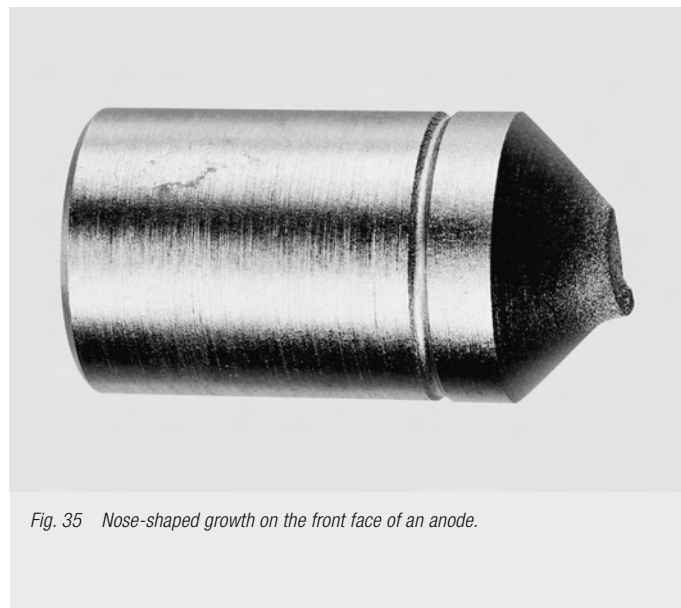

Fig. 35 Nose-shaped growth on the front face of an anode.

Burst lamp

XBO® lamps are made of quartz glass and have a high internal pressure (about 40 bar in operation). However, they are very safe and burst lamps are rare. Usually a burst lamp is preceded by damage to the lamp.

Possible reasons for a burst lamp:

- Lamp life exceeded by more than 25 %; advancing recrystallization weakens the mechanical strength of the quartz glass.
- Scratches on the outer skin of the quartz glass due to inappropriate handling (rolling around on a bench/shelf).

- Microscopic cracks caused by very dusty cooling air.
- Recrystallization on the surface of the quartz glass bulb caused by fingerprints which have not been removed and so have burned in.
- Excessive wattage, overcurrent. The higher the wattage input, the greater the internal pressure.
- Blackening. This causes a large part of the radiation from the lamp to be absorbed by the quartz, resulting in a rise in temperature and pressure which can lead to bursting. See page 31ff for the causes of blackening.

Discoloration of base, cable and cable lugs

XBO® lamps produce an extremely high concentration of electrical power, converting up to 12,000 watts in the small space contained by a lamp bulb. Most of the electrical power must be dissipated as heat by convection and radiation. Thermal blockages and excessive temperatures must be avoided.

The base temperature is a good indicator of correct thermal balance in the lamp (see section on "Operating parameters: Cooling" on page 28). If the upper limit of 230 °C is exceeded, the bases discolor light yellow, if the temperature is only exceeded a little, then straw yellow, yellow-orange, brown and blue.

If lamps with bases like these are found, the lamp's cooling system must first be checked.

The electrical connections must then be checked. These sometimes include the cables screwed into the bases. Loose screw contacts both give poor thermal contact resulting in insufficient thermal dissipation via the connecting cable, and also act as an additional heat source because of the increased contact resistance due to faulty electrical contact. Arcing spots and then rampant overheating are the consequence.

The adjustment of the lamp in its housing (its projector) may also have to be checked. If the optical components such as the deep-dish reflector are focusing the light on a base, this can also result in overheating.

Rarely, the various electrical connections inside the base between the electrode rod and the base are responsible for overheating.

The cause of a discolored base must always be ascertained before a new lamp is fitted. If the cable lugs of a lamp have turned blue or started to tarnish, the cause is always a loose electrical contact.

Not enough light

During the course of an XBO® lamp's life, the luminous flux is allowed to decrease by 30 %. (This is the definition of lamp life for XBO® lamps.) If the decrease is fairly severe or rapid, the following must be checked:

- Has the lamp noticeably blackened?
 - If yes:
 - Check the electrical data of the rectifier and the igniter.
 - Has the lamp been operated at overcurrent (overload)?
- Is the lamp being operated at the correct current?
- Has the electrode gap been noticeably reduced due to growth on the anode?
 - If yes, the lamp voltage is reduced and the lamp is consuming too little power. The reasons for the electrode growth must be elicited (see "Flicker", page 42).
- Is the lamp bulb contaminated on the outside by a dirty atmosphere?
- Is the optical system (reflector, lenses) contaminated?
- Is the optical adjustment of the lamp correct?

Uneven illumination	This fault occurs in slide and film projection. Uneven illumination of the screen (dark center or corners) is usually attributable to imperfect adjustment of the lamp in the optical system (the reflector) or to an incorrect mounting distance (distance between reflector and picture gate).
Shrinking lamp	In the past, there have been one or two cases of lamps becoming shorter during operation in the vertical burning position. This remarkable phenomenon was attributed to the effect of very slight but continuous vibration from, for example, a powerful fan, which caused the attachment of the lamp shaft in the lower base to loosen slightly and the lamp to slide little by little into the base. This type of shrinking lamp could be repaired. The lamp housing should also be checked for abnormally high vibration levels.
Continuous burning	XBO® lamps that do not go out even after the power supply plug has been withdrawn are extremely rare. It is more frequent for the average lamp life to be exceeded by considerable amounts. Care is recommended in all cases where 25 % of the average lamp life is exceeded, as the possibility of bursting due to recrystallization of the quartz glass is significantly increased. Lamp life records are not risk-free!
Safety Pressure	<p>Even when cold, XBO® lamps have a high internal pressure (of about 10 bar), and this rises to about 40 bar in operation. This means that burst lamps cannot be ruled out.</p> <p>XBO® lamps must therefore always be handled in their safety cover. Whenever work is carried out on XBO® lamps, leather gauntlets that effectively cover the arteries in the wrist and safety goggles, or better, protective masks that protect the arteries in the neck must be worn.</p>
Brilliance	XBO® lamps are nearly ideal point sources of light. The brilliance of the arc can exceed that of the sun. If the arc is viewed directly with the naked eye, this can severely damage the retina. Housings must therefore be designed to prevent the discharge arc from being viewed directly.
UV radiation	<p>Besides visible and infrared radiation, XBO® lamps emit nearly 6 % of the power they consume in the UV region below 380 nm. This radiation is harmful to health and can burn the skin (erythema) and damage the eyes (e. g. conjunctivitis).</p> <p>Unprotected use of XBO® lamps is therefore not permitted. Lamp housings must be designed so that neither direct radiation from the arc nor scattered radiation can emerge unfiltered. In appliances such as solar simulation equipment designed to utilize the UV radiation, the owner is responsible for protecting the operating personnel from UV radiation – and also from glare, see above – by means of suitable measures specific to the purpose.</p>
Generation of ozone	<p>A few types of XBO® lamp generate ozone during operation (see section on “Lamp behavior: Generation of ozone”, page 37). These are mainly types of lamp that are also used for solar simulation. They can be recognized from the fact that the letters “OFR” are not included in the lamp designation.</p> <p>With these types of lamp, damage to human health must be prevented by suitably extracting the air from the lamp housing and/or the operating room into the open air. Under no circumstances may the current maximum workplace concentration values be exceeded.</p>

A

Absorption	27, 31, 38
Anemometer	28
Anode	6, 7, 9, 11, 13, 16, 25, 26, 27, 28, 30, 31, 32, 33, 35, 36, 39, 40, 42, 43, 44
Arc	4, 5, 6, 7, 9, 10, 11, 12, 13, 14, 16, 17, 19, 22, 25, 26, 27, 28, 29, 30, 31, 33, 34, 35, 36, 37, 42, 43, 45
Arc deflection	35
Arc instability	16, 25, 26, 28, 33, 34, 35, 36, 37, 43
Arc length	6, 12, 16, 25
Arc radiation	14
Arc stability	33, 36
Arc stabilization	25, 26, 27, 31, 42
Auxiliary ignition capacitor	19, 42
Average lamp life	45

B

Base temperature	28, 44
Battery operation	23
Blackening	27, 28, 29, 31, 32, 33, 43, 44
Booster circuit	23
Brilliance	5, 10, 11, 12, 13, 14, 22, 33, 34, 37, 45
Bulb blackening	27, 31
Bulb cooling	28, 36
Bulb temperature	28, 31
Burn-in time	36
Burning position	25, 36
Burst lamp	43

C

Capillary seal	9
Cathode	6, 7, 10, 11, 13, 16, 19, 20, 25, 26, 28, 29, 30, 31, 32, 33, 34, 35, 36, 37, 39, 40, 42, 43
Color properties	14
Color rendering	5, 15
Color temperature	5, 15
Convection cooling	22
Cooling	5, 10, 22, 28, 29, 30, 31, 36, 44
Current-voltage characteristic	16, 18
Current control range	16, 29, 30, 42
Current ripple	19, 20, 21, 23, 31, 33, 36, 42, 43

D

Discharge arc	5, 6, 22, 33, 45
Disposal	41
Distribution of luminous intensity	13

E

Efficiency	7, 10, 11
Electrical characteristics	16
Electrode gap	6, 11, 12, 17, 23, 42, 44
Electrode material	43
Emission conditions	33
Exhaust tube	6
Expansion	7, 8, 22, 39
Extraction	22, 28, 29

F

Fan	29, 45
Fill pressure	10
Flicker	33, 36, 37, 42
Foil seal	7, 8
Forced cooling	22

G

Graded seal	8, 9
-------------	------

I

Igniter	17, 18, 23, 24, 31, 40, 42, 44
Ignition voltage	17, 18
Ignition wire	6, 10, 18, 42
Illumination	45
Infrared radiation	7, 45
Inrush current	18, 19, 31, 33, 36, 42
Internal resistance	16

L

Lamp adjustment	35
Lamp bulb	6, 9, 28, 39, 44
Lamp current	11, 19, 20, 21, 23, 33, 35, 36
Lamp housing	22, 25, 27, 28, 29, 31, 37, 39, 42, 45
Lamp life	5, 7, 10, 16, 19, 20, 21, 28, 29, 30, 31, 32, 43, 44, 45
Lamp shaft	45
Lamp voltage	11, 16, 17, 28, 44
Luminous area	12
Luminous efficacy	11
Luminous flux	11, 13, 16, 21, 25, 27, 31, 32, 33, 37, 44

M

Magnetic arc stabilization	25, 31, 42
Moly cup seal	8

N

Non-ignition	43
--------------	----

O

Open circuit voltage	17, 20, 23, 42
Operating conditions	36, 43
Operating duty cycle	30
Operating equipment	4, 16, 18, 42, 43
Operating parameters	22, 25, 44
Operating pressure	6
Operating temperature	36
Overcurrent	19, 30, 44
Overheating	28, 33, 35, 44
Oxidation protection	9
Ozone-free	14, 15, 22, 29, 38

P

Peak voltage	17
Picture gate	37, 42, 45
Pressure	5, 6, 8, 10, 11, 12, 22, 30, 39, 43, 44, 45

Q

Quartz glass bulb	28, 37, 44
-------------------	------------

R

Radiation	4, 6, 7, 11, 13, 14, 15, 22, 24, 27, 28, 31, 37, 38, 44, 45
Rated current	16, 19, 29, 30, 42
Recrystallization	31, 44
Rectifier	16, 17, 18, 19, 20, 23, 31, 33, 40, 42, 44
Reflector	25, 27, 28, 37, 42, 44, 45
Ripple	19, 20, 21, 23, 31, 33, 36, 42, 43
Risk of bursting	28, 31, 40

S

Safety	22, 39, 41, 45
Safety cover	22, 39, 41, 45
Safety goggles	41
Scratches	43
Seal glass	8
Sealing	8, 9
Series resistance	19, 42
Smoothing	20, 23
Solar simulation	4, 22, 30, 45
Standby operation	30
Startup	16, 19, 30
Startup time	36
Steady-state operation	18
Storage	41
Superimposing igniter	23, 24
Suprasil	14

T

Temperature	5, 7, 9, 10, 11, 15, 26, 28, 31, 36, 44
Tesla transformer	23
Tilt	25, 26, 31, 36
Transport	41
Tungsten	7, 8, 9, 11, 31, 32, 33, 41

U

Undercurrent	31, 33
UV radiation	6, 14, 15, 22, 38, 45

X

Xenon	4, 5, 6, 10, 11, 12, 14, 15, 25, 33, 37, 41
-------	---------------------------------------------

Global presence.

OSRAM supplies customers in around 150 countries.

- 65 companies and sales offices for 100 countries
- 48 countries served by local agents or OSRAM GmbH, Munich

OSRAM associated companies and support centres.

Argentina	Kazakhstan
Australia	Kenya
Austria	Latvia
Benelux	Lithuania
Bosnia-Herzegovina	Malaysia
Brazil	Mexico
Bulgaria	Norway
Canada	Philippines
Chile	Poland
China	Portugal
Columbia	Rumania
Croatia	Russia
Czech Republic	Serbia-Montenegro
Denmark	Singapore
Ecuador	Slovakia
Egypt	South Africa
Estonia	South Korea
Finland	Spain
France	Sweden
Germany	Switzerland
Great Britain	Taiwan
Greece	Thailand
Hungary	Turkey
India	Ukraine
Indonesia	United Arab Emirates
Iran	USA
Italy	Vietnam
Japan	

OSRAM GmbH

Head Office

Hellabrunner Strasse 1
81543 Munich
Tel.: +49-(0)89-6213-0
Fax: +49-(0)89-6213-2020
www.osram.com