



2019

entirely made in italy - since 1978



TECLUMEN



light in progress



Gilberto Cason.
Fondatore e Direttore Generale di Teclumen srl
Founder and CEO of Teclumen Ltd.

*...la qualità è il miglior
investimento nel tempo...*

*...quality is the best investment
in the course of time...*

COSA BISOGNA SAPERE SUL LED - WHAT DO YOU NEED TO KNOW ABOUT LEDS

INDOOR



COS'È?

Il led è un componente elettronico (diodo) che al passaggio di una minima corrente emette una luce priva di raggi infrarossi ed ultravioletti, accendendosi immediatamente ed alla massima potenza. Non attira pertanto la maggior parte degli insetti, sensibili a questo tipo di radiazioni.

WHAT IS IT?

The LED is an electronic component (diode) which is emitting light without infrared and ultraviolet rays when you feed it with a minimum current flow. The light will turn immediately to the maximum intensity. For that reason it does not attract the majority of insects sensitive to this kind of radiations.

OUTDOOR



RISPARMIO ENERGETICO

Nel confronto con fonti di illuminazione tradizionali il risparmio ottenuto utilizzando l'illuminazione a led è di circa il 90% rispetto alle lampade ad incandescenza, 85% rispetto alle lampada alogene, 70% rispetto alle lampade a ioduri metallici, 55% rispetto alle lampade fluorescenti. Il vantaggio è immenso, con notevole riduzione dei costi di esercizio e manutenzione.

ENERGY SAVINGS

Compared to traditional light sources the energy savings equal roughly 90%, compared to discharge lamps, 85% compared to halogen lamps, 70% compared to metal halide lamps and 55% compared to fluorescence tubes. The cost reduction effect on energy consumption and maintenance are huge.

STRIP



TEMPERATURA DEL COLORE

L'atmosfera negli ambienti è determinata dal colore della luce di una sorgente luminosa. Essa è espressa in gradi Kelvin (K). Le basse temperature (da 2500 a 3300) creano un'illuminazione calda, rilassante, usata per valorizzare i colori giallo e rosso. Le medie temperature (da 4500 a 6500) creano un'illuminazione definita luce naturale o neutra:

è infatti la luce emessa dal sole nelle ore centrali della giornata. Le alte temperature invece (oltre i 6500K) creano un ambiente freddo, valorizzando i colori blu e verde.

COLOUR TEMPERATURE

The atmosphere of an environment is determined by the colour temperature of a light source.

The colour temperature is expressed in degrees Kelvin (K). The lower colour temperatures (between 2500K and 3300K) are creating a warm, relaxing light to enhance the colours yellow and red. The mid-level colour temperatures (between 4500K and 6500K) are creating a light defined as neutral colour temperature. This is indeed the light emitted by the sun about noon. Colour temperatures beyond (6500K) create a cold environment enhancing the colours blue and green.

STRADALE



CAPACITÀ E DURATA

I led mantengono il 70% dell'emissione luminosa iniziale ancora dopo 50.000 ore. Con ciò non è detto che bisogna necessariamente sostituirli dopo tale periodo: se tale riduzione non crea eccessivi fastidi, si possono tranquillamente utilizzare fino alla completa perdita di luminosità, stimata in 100.000 ore. Confrontando la durata dei led rispetto alle lampade tradizionali notiamo che la vita media di una lampadina a filamento è di circa 2.000 ore, quella di una lampada a scarica è di circa 4.000 ore e quella di una lampada fluorescente di circa 7.000 ore.

PERFORMANCE AND DURABILITY

LEDs keep 70% of their initial light intensity even after 50.000 hours.

This does not necessarily mean that they have to be replaced after that period. If the reduction of light intensity is not causing negative effects they can be used until the complete loss of light intensity after 100.000 hours. When we compare the lifetime of an LED with traditional bulbs we note that the average lifetime of a bulb with filaments is about 2.000 hours, the lifetime of a discharge lamp is 4.000 hours and the lifetime of fluorescence tubes is 7.000 hours.

INDUSTRIALE



SALVAGUARDIA DELL'AMBIENTE

La direttiva RoHS, in vigore dal 2006 regola l'utilizzo di sostanze pericolose utilizzate per i prodotti elettronici. L'utilizzo della tecnologia a LED ha eliminato l'utilizzo del mercurio.

ENVIRONMENTAL PROTECTION

The RoHS regulation, in force since 2006 is regulating the usage of dangerous substances for electronic products. The LED technology has eliminated the need of mercury.



ACCESSO A FINANZIAMENTI PUBBLICI

Nel 2009 la Commissione Europea ha pubblicato il Regolamento (CE) n. 244/2009 che ha determinato la messa al bando graduale delle tradizionali lampadine a incandescenza. L'utilizzo dei LED permette di accedere a finanziamenti e di usufruire dei cosiddetti certificati bianchi (TEE - "Titoli di Efficienza Energetica").

ACCESS TO PUBLIC FUNDING

The European Community has published the regulation (CE) n. 244/2009 in 2009 which is defining the gradual ban of traditional incandescent light bulbs. The usage of LEDs is giving access to fundings and the so called white certificate (TEE - "Title of Energy Efficiency").



Teclumen nasce nel 1978 come ditta di assemblaggio di proiettori. Successivamente l'attenzione dell'azienda si focalizza sulla commercializzazione dei più famosi marchi nazionali ed internazionali. Con il passare degli anni l'esperienza nell'ambito lighting spinge l'azienda a creare un proprio marchio e a proporre una linea di prodotti teatrali made in Italy targati Teclumen.

Nel 2003 viene inaugurata la nuova sede direzionale e produttiva che concentra, all'interno di un'unica struttura, spazi destinati alla progettazione, all'assemblaggio dei prodotti, alla commercializzazione e all'assistenza post-vendita. L'efficacia della politica produttiva e commerciale di Teclumen, che distribuisce proiettori in tutto il mondo, ha permesso alla società di raggiungere un ruolo molto importante nello scenario internazionale dei corpi illuminanti.

Oggi l'azienda vanta una propria produzione in grado di soddisfare vari settori quali: l'illuminazione per il teatro, l'illuminazione architettonica e per giardini, proiettori e attrezzature per lo spettacolo, l'illuminazione di allestimenti fieristici, effetti scenografici per piscine e fontane.

Attraverso le proprie strutture e il proprio personale, Teclumen è in grado di sviluppare prodotti che soddisfino le esigenze del mercato mettendo sempre al primo piano la qualità. Attraverso le migliori tecnologie di progettazione 3D, la realizzazione di un prodotto parte dallo studio del design per proseguire con lo studio dell'ottica, della meccanica e per finire dell'elettronica.

Al fine di garantire un'elevata qualità, Teclumen realizza le fasi principali della produzione all'interno dell'azienda. La presenza di macchine altamente tecnologiche (macchine con taglio laser) permette una produzione rapida e flessibile. Per la scelta dei componenti Teclumen si avvale di partner affidabili e leader a livello internazionale quali: Philips, Osram, Lumileds; l'assemblaggio finale, fatto interamente all'interno dell'azienda, consente di raggiungere un alto livello qualitativo.

Teclumen dispone di un magazzino di prodotti finiti ben organizzato e funzionale, dotato di un'ampia scorta. Tali accorgimenti consentono tempi di consegna estremamente ridotti, rapidi e puntuali in tutto il mondo.

L'azienda è in grado di offrire una vasta gamma di servizi:

- consulenza pre-vendita: indicando quali siano i prodotti più indicati alle specifiche applicazioni e fornendo tutta la documentazione necessaria per un corretto acquisto;
- assistenza post-vendita: fornendo tutto il supporto necessario alla corretta installazione e al corretto utilizzo del prodotto; supportando con rapidi interventi di riparazione e/o sostituzione.



Teclumen started in 1978 as a projector assembling company, afterwards the company focused his activities on the commercialization of the most famous national and international brands. In the course of time, the experience in the lighting sector encourages the company to create its own trademark and to offer theatre fixtures, Made in Italy, branded Teclumen.

In 2003 Teclumen inaugurates his new directional and productive headquarters: offices for design, product assembling, sales and for after sales services are reunited in one structure. The effectiveness of production and sales has allowed the company to become a very important player in the international lighting sector: nowadays Teclumen exports all over the world.

Today the company has its own production and is able to meet the requests of many fields: the wide range of products includes: theatre lighting, lights and equipment for stages and shows, architectural lighting, exhibition lighting and lights to create scenographies in swimming pools and fountains.

Thanks to his organization and teamwork, Teclumen is in the position to develop products that satisfy the demands of the market, always taking care of quality in the first place. The realisation of a product starts with a design-study to proceed afterwards with the optics, mechanics and electronics by using the best design technologies 3D.

The main phases of the production and manufacturing process take place into the company, in order to guarantee high quality products. The production is fast and flexible thanks to high tech tools and machinery (laser cut, bending, welding machines, etc.). Teclumen selects and works with components of reliable partners, world-wide leaders (such as Philips, Lumileds, etc.). The final assembling is taking place entirely into the company itself, which allows to reach a high quality level. Teclumen has a well structured and functional warehouse with a wide stock of products. This organization allows quick deliveries all over the world.

Teclumen offers a vast range of services:

- advice before sales: assistance, suggestions and all the necessary documentation in order to help the customer to choose the right product and to satisfy his needs;
- after sales service: technical support for the correct installation and correct use of the products, quick reparations or eventual substitutions, if necessary.



INDOOR

OUTDOOR

STRIP

ROAD

INDUSTRIAL

INDOOR



MIGNON L4
pag 12



MIGNON QL4
pag 13



MIGNON TL4
pag 14



MIGNON BL4
pag 15



MIGNON BL8
pag 16



MIGNON RGBW
pag 17



MIGNON Q RGBW DMX
pag 18



MIGNON T RGBW DMX
pag 19



STAR 9
pag 20



STAR 6 RGBW
pag 21



LD6
pag 22



LD7
pag 23



LD8
pag 24



LD9
pag 25



LD10
pag 26



SOLAR
pag 30



SOLAR XL
pag 32



MINI PONY F/PC
pag 33



MINI PONY F/PC DMX - DALI
pag 34



MINI PONY PROFILE
pag 35



MINI PONY PROFILE DMX- DALI
pag 36



MODERNA
pag 37

OUTDOOR



FLOR RGBW
pag 42



MINI FLOOR RGBW
pag 43



MINI FLOOR WHITE
pag 44



POINT RGBW
pag 45



POINT WHITE
pag 46

INDOOR

OUTDOOR

STRIP

STRADALE

INDUSTRIALE

				
POINT Q WHITE pag 47	POINT F WHITE pag 48	POINT QF WHITE pag 49	MINI POINT WHITE pag 50	MINI POINT F WHITE pag 51
				
POINT L1 WHITE pag 52	POINT L2 WHITE pag 53	RIGA WHITE pag 56	RIGA IN WHITE pag 57	RIGA IN F WHITE pag 58
				
FUSION WHITE pag 59	FUSION RGBW ECO pag 60	MICRO WHITE pag 61	MICRO RGBW pag 62	MONO T pag 63
				
DOUBLE T pag 64	MONO Q pag 65	DOUBLE Q pag 66	RIQUADRO MICROLED pag 67	RIQUADRO GR pag 68
				
PLAFONIERA LED A PARET pag 69	TERRA 1000 pag 70	TERRA 500 pag 71	FORTE PROFILE 150 HD WL pag 74	FORTE PROFILE 150 HD WL pag 75
				
FORTE PROFILE 150 HD DALI pag 76	FORTE PROFILE 150 HD DALI pag 77	FORTE PROFILE 150 HD DMX pag 78	FORTE PROFILE 150 HD DMX pag 79	FORTE PROFILE 150 HD pag 80

INDOOR

OUTDOOR

STRIP

ROAD

INDUSTRIAL

INDOOR



FORTE PROFILE 150 HD
pag 81



FORTE PROFILE 150
pag 82



FORTE PROFILE 150
pag 83



FORTE 150 WL F/PC
pag 84



FORTE 150 DMX F/PC
pag 85

OUTDOOR



FORTE 150 F/PC
pag 86

STRIP



STRIP LED RGB FC
pag 90



STRIP LED WHITE POWER IP65
pag 91



STRIP LED WHITE IP20
pag 92



STRIP LED WHITE POWER IP20
pag 93



PROFILO WIDE
pag 94

STRIP

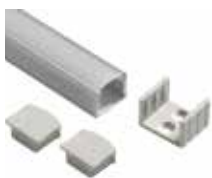

PROFILO
pag 94



PROFILO ROTONDO
pag 95



PROFILO INCASSO WALL
pag 95



PROFILO SLIM
pag 96



PROFILO DA INCASSO
pag 96

STRADALE



PROFILO TRIANGOLARE
pag 97

STRADALE

INDUSTRIALE



SUNLEAD AS
pag 100



SMART AS
pag 101



SMART FW
pag 102



SMART S1
pag 103



SMART S2
pag 104

				
SMART S3 pag 105	SATURN A pag 106	SATURN P pag 107	SATURN S pag 108	SATURN T pag 109
INDUSTRIALE				
				
MODULO 2 GILBERT 1000 VT pag 114	MODULO 2 GILBERT 1000 PC pag 115	MODULO 5 GILBERT 500 VT pag 116	MODULO 5 GILBERT 500 PC pag 117	MODULO 4 GILBERT 500 VT pag 118
				
MODULO 4 GILBERT 500 PC pag 119	MODULO 3 GILBERT 500 VT pag 120	MODULO 3 GILBERT 500 PC pag 121	GILBERT 1500 VT pag 124	GILBERT 1500 PC pag 125
				
GILBERT 1000 VT pag 126	GILBERT 1000 PC pag 127	GILBERT 500 VT pag 128	GILBERT 500 PC pag 129	MODULO 640 pag 132
				
MODULO 36 pag 133	MODULO 320 pag 134	MODULO 18 pag 135	MODULO 160 pag 136	MODULO 9 pag 137
				
MIRA 150-80-50 pag 140-144	PANEL T LED 60x60 pag 147	STAR 160 pag 148	STAR 80 pag 149	

INDOOR

OUTDOOR

STRIP

ROAD

INDUSTRIAL



L'illuminazione degli spazi interni deve in primo luogo incidere sulla percezione della bellezza dello spazio architettonico senza rinunciare ad essere funzionale ed orientata soprattutto al soddisfacimento di tre requisiti: il comfort, la possibilità di creare atmosfere suggestive e una forte differenziazione tra ambiente diurno e notturno.

Indoor lighting is mainly supposed to have an impact on the beauty of the architectural spaces without underestimating its functionality and especially to meet the three requirements, the comfort, the option to create evocative atmospheres and a strong differentiation between a day and night environment.





INDOOR



Illuminatori per interni progettati per l'installazione ad incasso in controsoffitti o cartongessi disponibili in diverse misure e potenze.

Indoor illuminators designed for recessed installation in false ceilings or plasterboard available in different sizes and powers.



A modern office interior with a white grid ceiling, recessed lighting, and air vents. The room features a long desk with two white office chairs, a printer on a cart, and a large window with a circular opening. The floor is light wood. A central pillar is visible. The word "INCASSO" is overlaid in white on an orange background.

INCASSO

MIGNON L4

Faretto da incasso per interni a 4 LED ad alta potenza, pilotabile a 500 mA a corrente costante.

Indoor recessed 4 LEDs fitting with high power light output, driveable with 500 mA constant current.

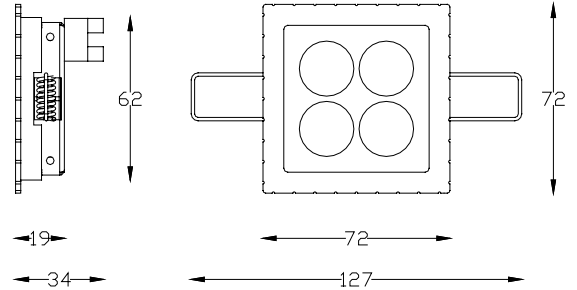
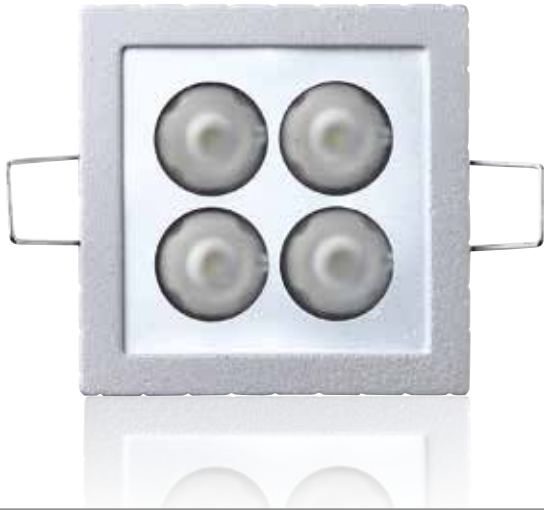

DATI TECNICI - TECHNICAL DATA



500 mA



6,9 W

CRI

80



CL III



ALUMINIUM



0.085 Kg

IP

20

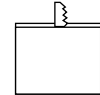

L 63

VARIANTI - OPTIONS

Cod.	Temperatura colore Color temperature	Flusso Luminoso Luminous flux	Apertura Fascio Beam angle	€
8804715104	Naturale 4000 K	690 lumen	80°	
8804715190	Caldo 3000 K	610 lumen	80°	
8804005104	Naturale 4000 K	690 lumen	35°	
8804005204	Caldo 3000 K	610 lumen	35°	
8804625104	Naturale 4000 K	690 lumen	19°	
8804625204	Caldo 3000 K	610 lumen	19°	

ACCESSORI - ACCESSORIES

Cod. 0205000024
Alimentatore in
corrente 0,5 A 16 W
da 1 a 2 Mignon

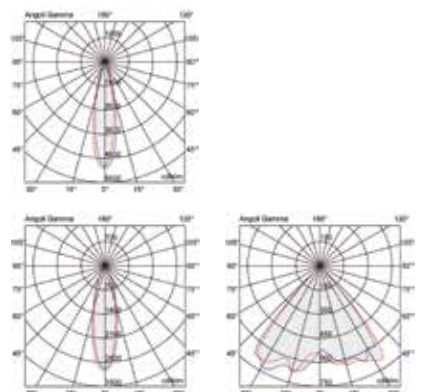

MIGNON QL4



Faretto da incasso per interni a 4 LED ad alta potenza, pilotabile a 500 mA a corrente costante, con cornice quadrata.

Indoor recessed 4 LEDs fitting with high power light output, driveable with 500 mA constant current with square frame.

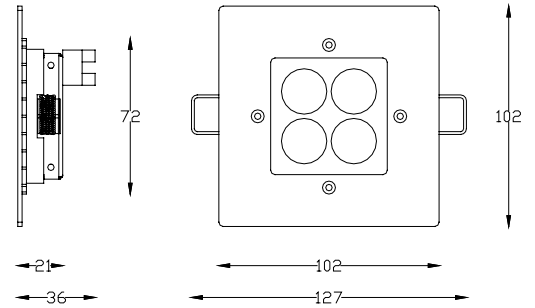

DATI TECNICI - TECHNICAL DATA



500 mA



6,9 W

CRI

80



CL III



ALUMINIUM



0.125 Kg

IP

20

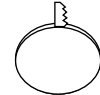

Ø 92

VARIANTI - OPTIONS

Cod.	Temperatura colore Color temperature	Flusso Luminoso Luminous flux	Apertura Fascio Beam angle	€
8804715746	Naturale 4000 K	690 lumen	80°	
8804755790	Caldo 3000 K	610 lumen	80°	
8804005764	Naturale 4000 K	690 lumen	35°	
8804625790	Caldo 3000 K	610 lumen	35°	
8804625746	Naturale 4000 K	690 lumen	19°	
8804385790	Caldo 3000 K	610 lumen	19°	

ACCESSORI - ACCESSORIES

Cod. 0205000024
Alimentatore in
corrente 0,5 A 16 W
da 1 a 2 Mignon

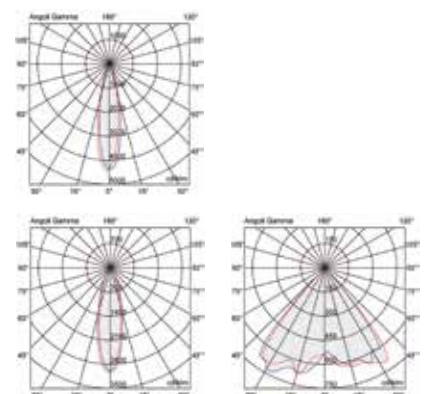

MIGNON TL4

Faretto da incasso per interni a 4 LED ad alta potenza, pilotabile a 500 mA a corrente costante.

Indoor recessed 4 LEDs fitting with high power light output, driveable with 500 mA constant current.

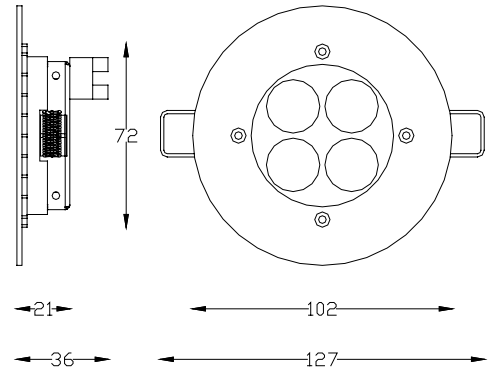

DATI TECNICI - TECHNICAL DATA

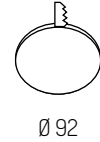

VARIANTI - OPTIONS

Cod.	Temperatura colore Color temperature	Flusso Luminoso Luminous flux	Apertura Fascio Beam angle	€
8804715846	Naturale 4000 K	690 lumen	80°	
8804715890	Caldo 3000 K	610 lumen	80°	
8804005864	Naturale 4000 K	690 lumen	35°	
8804535890	Caldo 3000 K	610 lumen	35°	
8804625846	Naturale 4000 K	690 lumen	19°	
8804385890	Caldo 3000 K	610 lumen	19°	

ACCESSORI - ACCESSORIES

Cod. 0205000024
Alimentatore in
corrente 0,5 A 16 W
da 1 a 2 Mignon

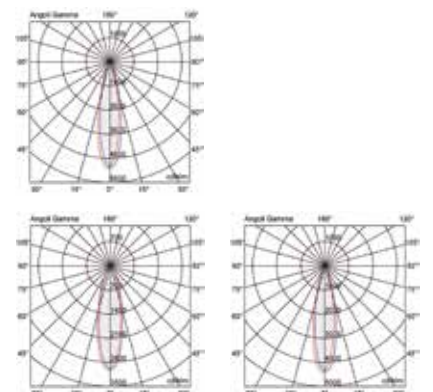

MIGNON BL4

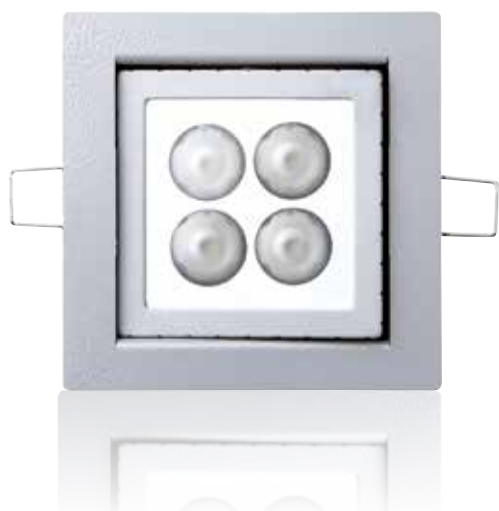

Faretto da incasso basculante per interni a 4 LED ad alta potenza, pilotabile a 500 mA a corrente costante.

Orientable indoor recessed 4 LEDs fitting with high power light output, driveable with 500 mA constant current.

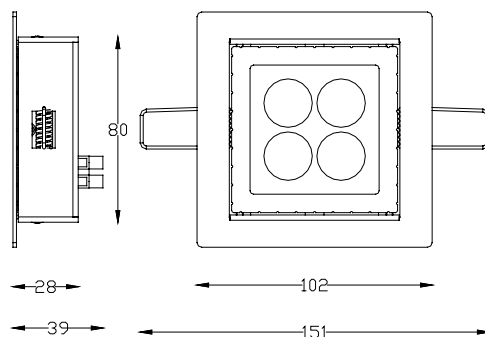

DATI TECNICI - TECHNICAL DATA



500 mA



6,9 W

CRI

80



CL III



ALUMINIUM



0.15 Kg

IP

20



L 84

VARIANTI - OPTIONS

Cod.	Temperatura colore Color temperature	Flusso Luminoso Luminous flux	Apertura Fascio Beam angle	€
8804756104	Naturale 4000 K	690 lumen	80°	
8804756190	Caldo 3000 K	610 lumen	80°	
8804315104	Naturale 4000 K	690 lumen	35°	
8804315190	Caldo 3000 K	610 lumen	35°	
8804626104	Naturale 4000 K	690 lumen	19°	
8804385190	Caldo 3000 K	610 lumen	19°	

ACCESSORI - ACCESSORIES

Cod. 0205000024
Alimentatore in
corrente 0,5 A 16 W
da 1 a 2 Mignon

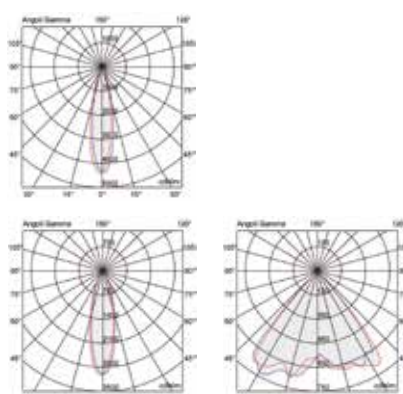

MIGNON BL8

Faretto da incasso basculante per interni a 8 LED ad alta potenza, pilotabile a 500 mA a corrente costante.

Orientable indoor recessed 8 LEDs fitting with high power light output, driveable with 500 mA constant current.

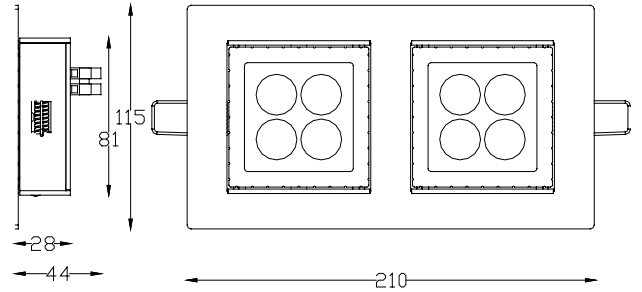

INDOOR

OUTDOOR

STRIP

STRADALE

INDUSTRIALE

DATI TECNICI - TECHNICAL DATA

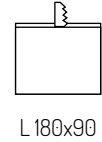

VARIANTI - OPTIONS

Cod.	Temperatura colore Color temperature	Flusso Luminoso Luminous flux	Apertura Fascio Beam angle	€
8804756204	Naturale 4000 K	1.380 lumen	80°	
8804756290	Caldo 3000 K	1.220 lumen	80°	
8804536204	Naturale 4000 K	1.380 lumen	35°	
8804536290	Caldo 3000 K	1.220 lumen	35°	
8804626204	Naturale 4000 K	1.380 lumen	19°	
8804386290	Caldo 3000 K	1.220 lumen	19°	

ACCESSORI - ACCESSORIES

Cod. 0205000024
Alimentatore in
corrente 0,5 A 16 W
1 Mignon BL8

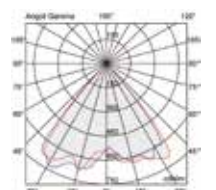
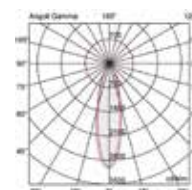
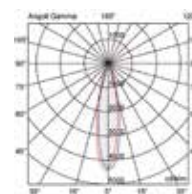

MIGNON RGBW

Faretto cambia colori RGBW da incasso per interni con 1 LED Full Color ad alta potenza pilotabile con segnale DMX.

Indoor recessed RGBW colour changer fitting with 1 Full color high power LED, driveable with DMX signal.

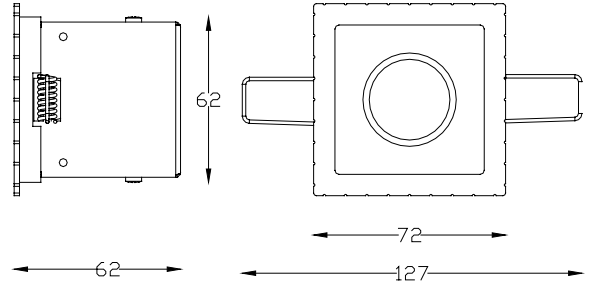

DATI TECNICI - TECHNICAL DATA



12 V AC



15 W



DMX



CL III



ALUMINIUM



0.14 Kg

IP

20



L 63



RGBW

VARIANTI - OPTIONS

Cod.	Temperatura colore Color temperature	Flusso Luminoso Luminous flux	Apertura Fascio Beam angle	€
8804565904	RGBW	432 lumen	120°	
8804545904	RGBW	432 lumen	45°	
8804385904	RGBW	432 lumen	25°	

ACCESSORI - ACCESSORIES

Cod. 33161801
Dmx box - controller
dmx per quadro
elettrico



Cod. 4494000000
Telecomando +
ricevitore per dmx box



Cod. 29090106
Sunlite Stick Gu2



Cod. 0513170031
Trasformatore toroidale
230 V AC-12 V AC,
60 W

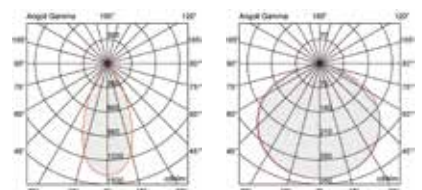

MIGNON Q RGBW DMX

INDOOR



Faretto cambia colori RGBW da incasso per interni con 1 LED Full Color ad alta potenza pilotabile con segnale DMX con cornice quadrata.

Indoor recessed RGBW colour changer fitting with 1 Full color high power LED, driveable with DMX signal with square frame.

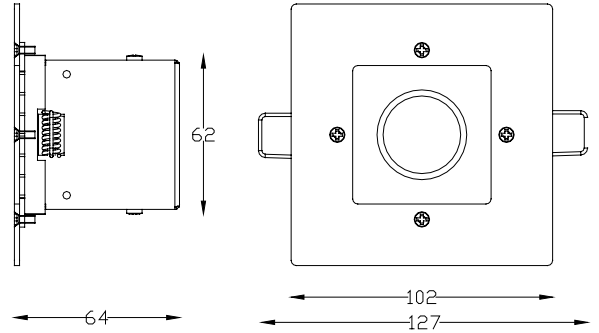

OUTDOOR

DATI TECNICI - TECHNICAL DATA



12 V AC



15 W



DMX



CL III



ALUMINIUM



0.14 Kg



20



Ø 92



RGBW

STRIP

VARIANTI - OPTIONS

Cod.	Temperatura colore Color temperature	Flusso Luminoso Luminous flux	Apertura Fascio Beam angle	€
8804565704	RGBW	432 lumen	120°	
8804545704	RGBW	432 lumen	45°	
8804625704	RGBW	432 lumen	25°	

ACCESSORI - ACCESSORIES

Cod. 33161801
Dmx box - controller
dmx per quadro
elettrico



Cod. 4494000000
Telecomando +
ricevitore per dmx box



Cod. 29090106
Sunlite Stick Gu2



Cod. 0513170031
Trasformatore toroidale
230 V AC-12 V AC,
60 W



STRADALE



INDUSTRIALE

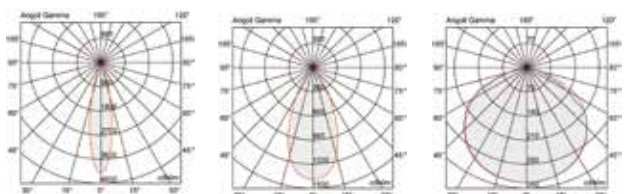

MIGNON T RGBW DMX

Faretto cambia colori RGBW da incasso per interni con 1 LED Full Color ad alta potenza pilotabile con segnale DMX con cornice tonda.

Indoor recessed RGBW colour changer fitting with 1 Full color high power LED, driveable with DMX signal with round frame.

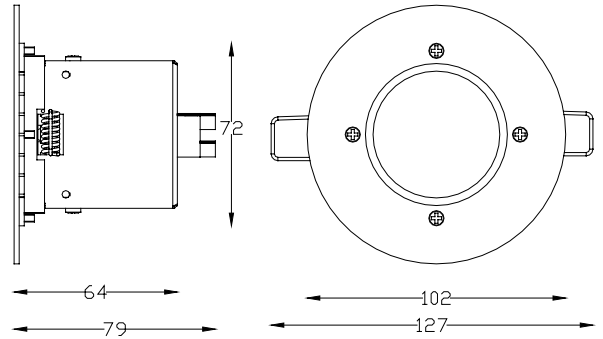

DATI TECNICI - TECHNICAL DATA



12 V AC



15 W



DMX



CL III



ALUMINIUM



0.14 Kg



20



Ø 92



RGBW

VARIANTI - OPTIONS

Cod.	Temperatura colore Color temperature	Flusso Luminoso Luminous flux	Apertura Fascio Beam angle	€
8804565804	RGBW	432 lumen	120°	
8804545804	RGBW	432 lumen	45°	
8804385841	RGBW	432 lumen	25°	

ACCESSORI - ACCESSORIES

Cod. 33161801
Dmx box - controller
dmx per quadro
elettrico



Cod. 4494000000
Telecomando +
ricevitore per dmx box



Cod. 29090106
Sunlite Stick Gu2



Cod. 0513170031
Trasformatore toroidale
230 V AC-12 V AC,
60 W

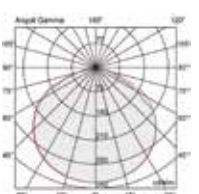
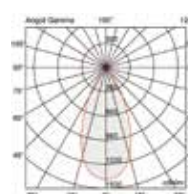
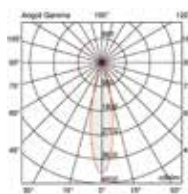
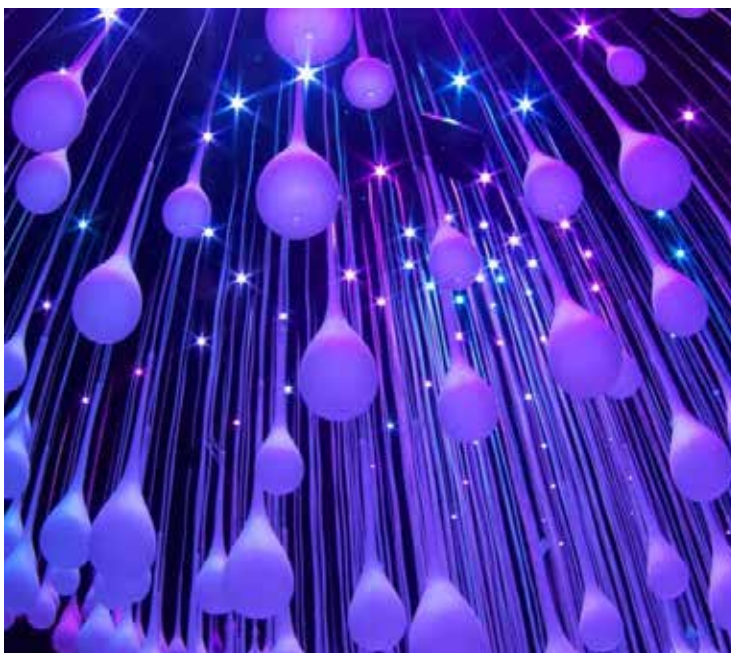

STAR 9

Lampada a 36 LED (9 led multichip) ad alta potenza a basso consumo ed ad alta efficienza, per incasso interno.. Consumo massimo 58W.

Indoor recessed fitting with 36 high power LEDs (9 multichip LEDs), low consumption and high efficiency. Max power consumption 58W.

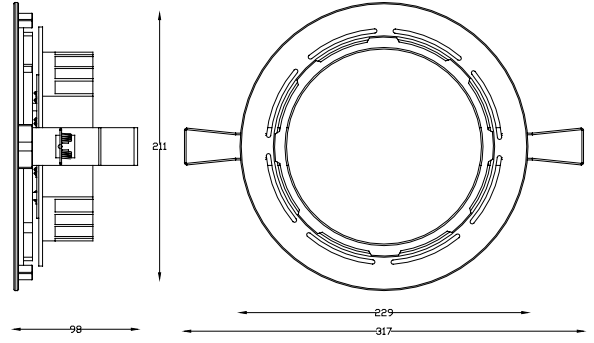

DATI TECNICI - TECHNICAL DATA



220-240 V AC



58 W

CRI

80



CL I



ALUMINIUM



2 Kg

IP

40



Ø 215

VARIANTI - OPTIONS

Cod.	Temperatura colore Color temperature	Flusso Luminoso Luminous flux	Apertura Fascio Beam angle	€
7709711264	Naturale 4000 K	5800 lumen	65°	
7709711290	Caldo 3000 K	5460 lumen	65°	
7709541264	Naturale 4000 K	5800 lumen	45°	
7709541290	Caldo 3000 K	5460 lumen	45°	
7712621264	Naturale 4000 K	5800 lumen	21°	
7712621290	Caldo 3000 K	5460 lumen	21°	

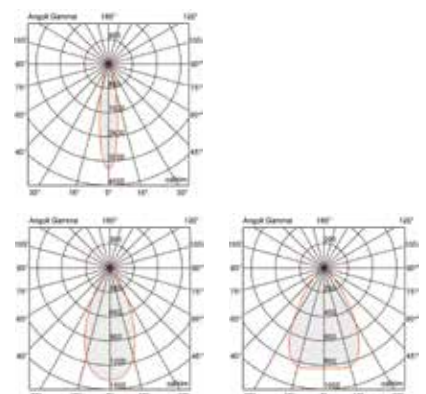

STAR 6 RGBW

Proiettore cambia colori a 24 LED ad alta potenza da incasso con sistema RGBW per interno pilotabile con segnale DMX 512. 6 canali DMX. effetti strobo e rainbow a velocità regolabile.

24 LED colour changer with RGBW system for indoor use driveable with DMX 512-A signal. 6 DMX channels, strobe and rainbow effects at adjustable speed.

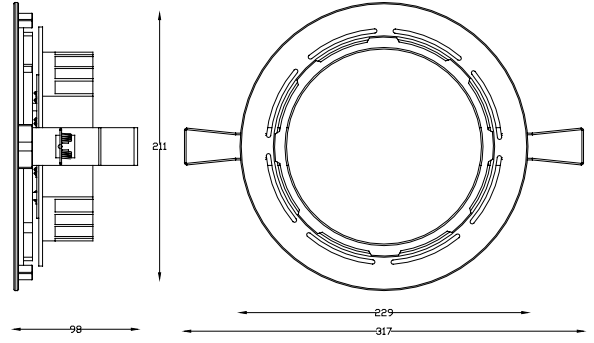

DATI TECNICI - TECHNICAL DATA



VARIANTI - OPTIONS

Cod.	LED Color	Flusso Luminoso Luminous flux	Apertura Fascio Beam angle	€
7700564294	RGBW	1896 lumen	120°	
7700544294	RGBW	1896 lumen	65°	
7700534394	RGBW	1896 lumen	45°	
7700394294	RGBW	1896 lumen	21°	

ACCESSORI - ACCESSORIES

Cod. 33161801
Dmx box - controller
dmx per quadro
elettrico



Cod. 4494000000
Telecomando +
ricevitore per dmx box



Cod. 29090106
Sunlite Stick Gu2

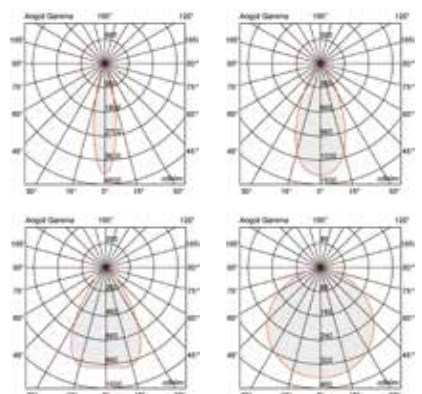

LD6

Faretto da incasso per interni a 1 LED ad alta potenza da 1,5 W pilotabile a 500 mA a corrente costante.

1 high power LED recessed indoor fixture with 1,5 W power consumption and driveable by a 500 mA power supply.

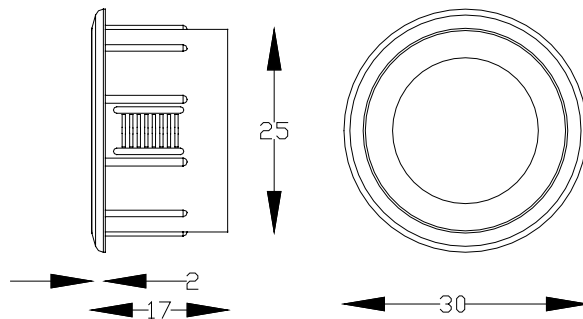

DATI TECNICI - TECHNICAL DATA



500 mA



1,5W

CRI

80



CL III



PLASTIC



0,09 Kg

IP

20



Ø 25

VARIANTI - OPTIONS

Cod.	Temperatura colore Color temperature	Flusso Luminoso Luminous flux	Apertura Fascio Beam angle	€
2314727885	Naturale 4000 K	94 lumen	60°	
2314727881	Caldo 3000 K	94 lumen	60°	
2314727882	BLU	-	60°	
2314717885	Naturale 4000 K	94 lumen	30°	
2314717881	Caldo 3000 K	94 lumen	30°	
2314737882	BLU	-	30°	

ACCESSORI - ACCESSORIES

Cod. 0205000024
Alimentatore in
corrente 0,5 A 16 W
da 1 a 10 LED



Cod. 1501170015
Scheda elettronica 12 V



Cod. 0513170031
Trasformatore toroidale
230 V AC-12 V AC,
60 W

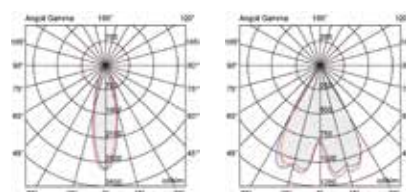

LD7

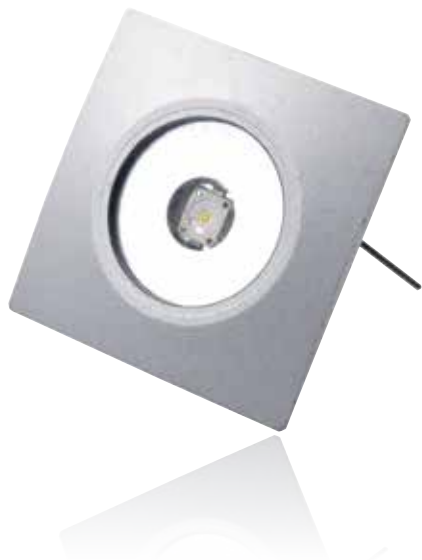

Faretto da incasso per interni ed esterni a 1 LED ad alta potenza da 1,5 w pilotabile a 500 mA a corrente costante.

1 high power LED recessed for indoor and outdoor use fixture with 1,5 W power consumption and driveable by a 500 mA power supply.

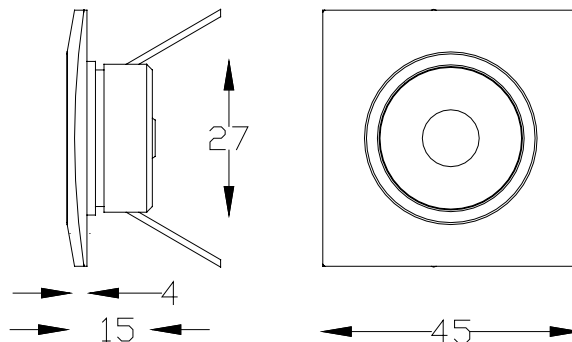

DATI TECNICI - TECHNICAL DATA



500 mA



1,5W

CRI

80



CL III



ALUMINIUM



0,03 Kg

IP

65



Ø 27

VARIANTI - OPTIONS

Cod.	Temperatura colore Color temperature	Flusso Luminoso Luminous flux	Apertura Fascio Beam angle	€
2313737880	Naturale 4000 K	79 lumen	150°	
2313737881	Caldo 3000 K	71 lumen	150°	
2302737882	BLU	-	150°	

ACCESSORI - ACCESSORIES

Cod. 0205000024
Alimentatore in
corrente 0,5 A 16 W
da 1 a 10 LED



Cod. 1501170015
Scheda elettronica 12 V



Cod. 0513170031
Trasformatore toroidale
230 V AC-12 V AC,
60 W

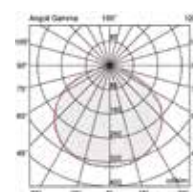

LD8

INDOOR



Faretto da incasso per interni ed esterni a 1 LED ad alta potenza da 1,5 w pilotabile a 500 mA a corrente costante.

1 high power LED recessed for indoor and outdoor use fixture with 1,5 W power consumption and driveable by a 500 mA power supply with frost filter.

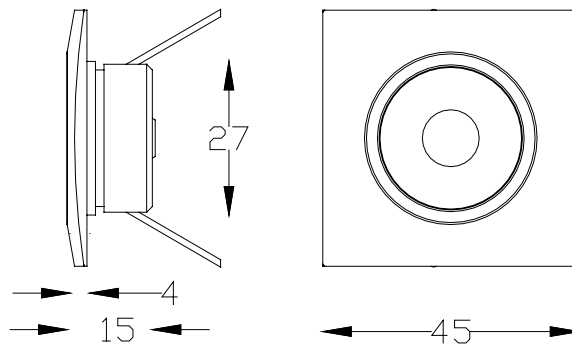

OUTDOOR

DATI TECNICI - TECHNICAL DATA



500 mA



1,5W

CRI

80



CL III



ALUMINIUM



0,03 Kg

IP

65



Ø 27

STRIP

VARIANTI - OPTIONS

Cod.	Temperatura colore Color temperature	Flusso Luminoso Luminous flux	Apertura Fascio Beam angle	€
2313737885	Naturale 4000 K	79 lumen	FROST	
2313737882	Caldo 3000 K	71 lumen	FROST	
2313737800	BLU	-	FROST	

ACCESSORI - ACCESSORIES

Cod. 0205000024
Alimentatore in
corrente 0,5 A 16 W
da 1 a 10 LED



Cod. 1501170015
Scheda elettronica 12 V



Cod. 0513170031
Trasformatore toroidale
230 V AC-12 V AC,
60 W



STRADALE

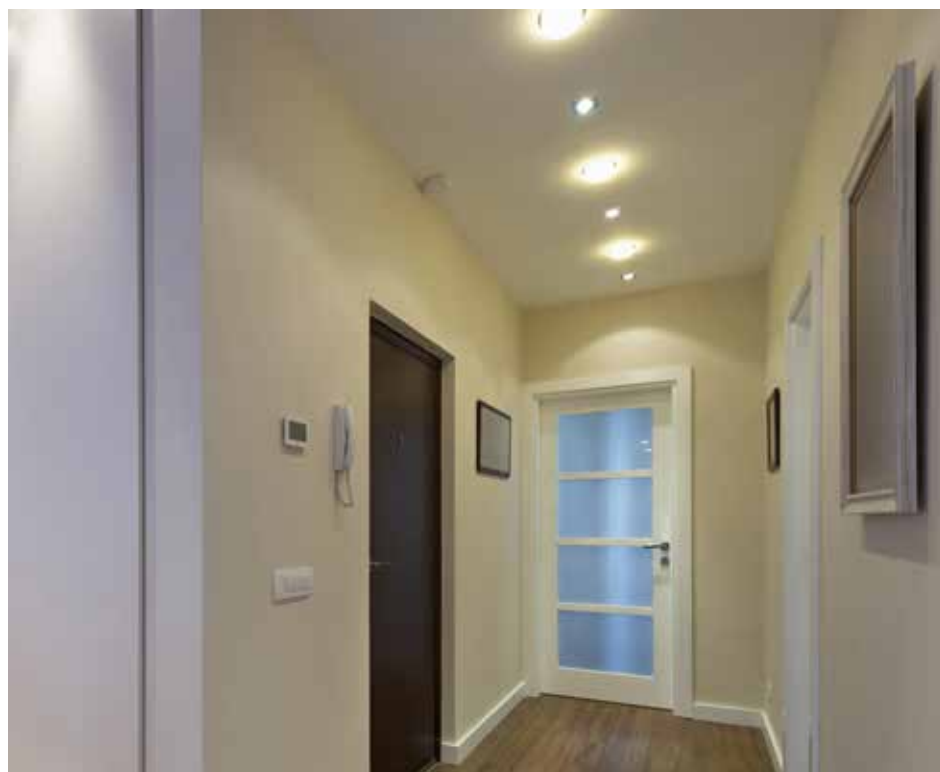

INDUSTRIALE

LD9



Faretto da incasso per interni ed esterni a 1 LED ad alta potenza da 1,5 w pilotabile a 500 mA a corrente costante.

1 high power LED recessed for indoor and outdoor use fixture with 1,5 W power consumption and driveable by a 500 mA power supply.

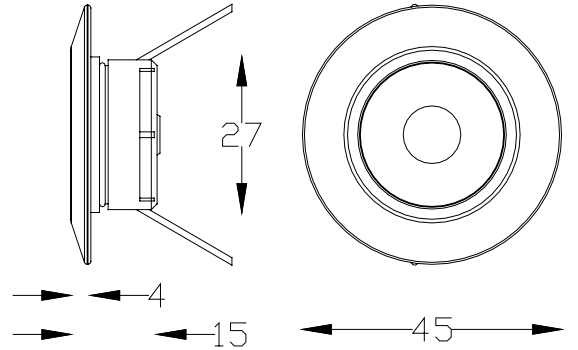

DATI TECNICI - TECHNICAL DATA



500 mA



1,5W

CRI

80



CL III



ALUMINIUM



0,025 Kg

IP

65

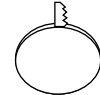

Ø 27

VARIANTI - OPTIONS

Cod.	Temperatura colore Color temperature	Flusso Luminoso Luminous flux	Apertura Fascio Beam angle	€
2313737883	Naturale 4000 K	79 lumen	150°	
2313737884	Caldo 3000 K	71 lumen	150°	
2301737882	BLU	-	150°	

ACCESSORI - ACCESSORIES

Cod. 0205000024
Alimentatore in
corrente 0,5 A 16 W
da 1 a 10 LED



Cod. 1501170015
Scheda elettronica 12 V



Cod. 0513170031
Trasformatore toroidale
230 V AC-12 V AC,
60 W

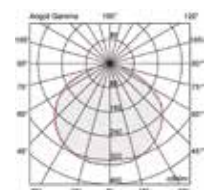

LD10

INDOOR



Faretto da incasso per interni ed esterni a 1 LED ad alta potenza da 1,5 W pilotabile a 500 mA a corrente costante.

1 high power LED recessed for indoor and outdoor use fixture with 1,5 W power consumption and driveable by a 500 mA power supply with frost filter.

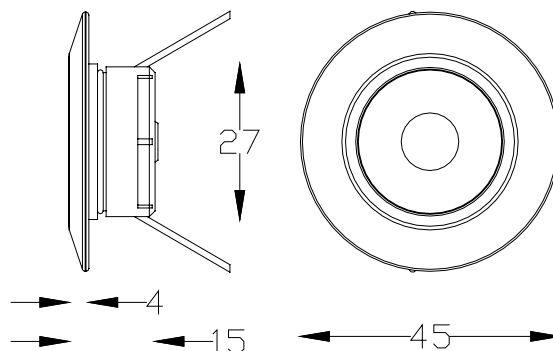

OUTDOOR

DATI TECNICI - TECHNICAL DATA



500 mA



1,5W

CRI

80



CL III



ALUMINIUM



0,025 Kg

IP

65



Ø 27

STRIP

VARIANTI - OPTIONS

Cod.	Temperatura colore Color temperature	Flusso Luminoso Luminous flux	Apertura Fascio Beam angle	€
2300007885	Naturale 4000 K	79 lumen	FROST	
2300007881	Caldo 3000 K	71 lumen	FROST	
2300007882	BLU	-	FROST	

ACCESSORI - ACCESSORIES

Cod. 0205000024
Alimentatore in
corrente 0,5 A 16 W
da 1 a 10 LED



Cod. 1501170015
Scheda elettronica 12 V



Cod. 0513170031
Trasformatore toroidale
230 V AC-12 V AC,
60 W



STRADALE



INDUSTRIALE



PEZZINI



PEZZINI





Questa gamma di proiettori è particolarmente adatta ad illuminare oggetti esposti in vetrine, scaffali, all'interno di aree espositive, con la capacità di mettere in risalto i particolari più attraenti.

This range of projectors is particularly suitable for illuminating objects displayed in shop windows, shelves, inside exhibition areas, with the ability to highlight the most attractive details.





SPOT/PROFILE

SOLAR



Proiettore orientabile a LED da 35W con attacco per binario elettrificato. LED COB, Corpo bianco, nero o grigio in alluminio con raffreddamento a convezione naturale.

35W Adjustable LED spotlight for electrified tracks with COB LED. The body is white, black or grey aluminium and the cooling is made by natural convection.

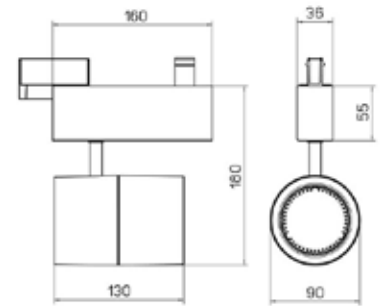

DATI TECNICI - TECHNICAL DATA



230 V AC



35 W

CRI

80



CL I



ALUMINIUM



1,35 Kg

IP

20

VARIANTI - OPTIONS

Cod.	Colore Colors	Temperatura colore Color temperature	Flusso Luminoso Luminous flux	Apertura Fascio Beam angle	€
67300LBC25	Bianco / White	3000K	4170 lumen	25°	
67300LBC40	Bianco / White	3000K	4170 lumen	40°	
67301LBC25	Nero / Black	3000K	4170 lumen	25°	
67301LBC40	Nero / Black	3000K	4170 lumen	40°	
67302LBC25	Grigio / Grey	3000K	4170 lumen	25°	
67302LBC40	Grigio / Grey	3000K	4170 lumen	40°	
67300LBN25	Bianco / White	4000K	4400 lumen	25°	
67300LBN40	Bianco / White	4000K	4400 lumen	40°	
67301LBN25	Nero / Black	4000K	4400 lumen	25°	
67301LBN40	Nero / Black	4000K	4400 lumen	40°	
67302LBN25	Grigio / Grey	4000K	4400 lumen	25°	
67302LBN40	Grigio / Grey	4000K	4400 lumen	40°	

SOLAR XL



Proiettore orientabile a LED da 41W con attacco per binario elettrificato. LED COB. Corpo bianco, nero o grigio in alluminio con raffreddamento a convezione naturale.

41W Adjustable LED spotlight for electrified tracks with COB LED. The body is white, black or grey aluminium and the cooling is made by natural convection.

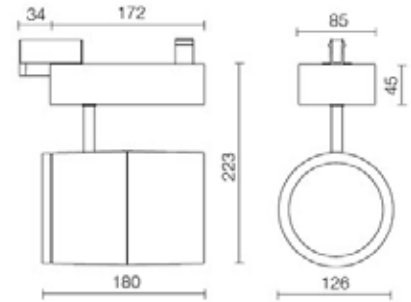

DATI TECNICI - TECHNICAL DATA



230 V AC



41 W

CRI

80



CL I



ALUMINIUM



2,4 Kg

IP

20

VARIANTI - OPTIONS

Cod.	Colore Colors	Temperatura colore Color temperature	Flusso Luminoso Luminous flux	Apertura Fascio Beam angle	€
67305LBC25	Bianco / White	3000K	4740 lumen	25°	
67305LBC60	Bianco / White	3000K	4740 lumen	60°	
67306LBC25	Nero / Black	3000K	4740 lumen	25°	
67306LBC60	Nero / Black	3000K	4740 lumen	60°	
67307LBC25	Grigio / Grey	3000K	4740 lumen	25°	
67307LBC60	Grigio / Grey	3000K	4740 lumen	60°	
67305LBN25	Bianco / White	4000K	4970 lumen	25°	
67305LBN60	Bianco / White	4000K	4970 lumen	60°	
67306LBN25	Nero / Black	4000K	4970 lumen	25°	
67306LBN60	Nero / Black	4000K	4970 lumen	60°	
67307LBN25	Grigio / Grey	4000K	4970 lumen	25°	
67307LBN60	Grigio / Grey	4000K	4970 lumen	60°	

INDOOR

OUTDOOR

STRIP

ROAD

INDUSTRIAL

MINI PONY F/PC

Spot maneggevole dalle dimensioni compatte, con sorgente a LED da 50 W con lente Fresnel o PC, regolazione manuale dello zoom, completo di telaio porta gelatina.

Handy spotlight with small dimensions, with 50W LED source, Fresnel or PC lens, manual regulation of zoom, complete with color frame.

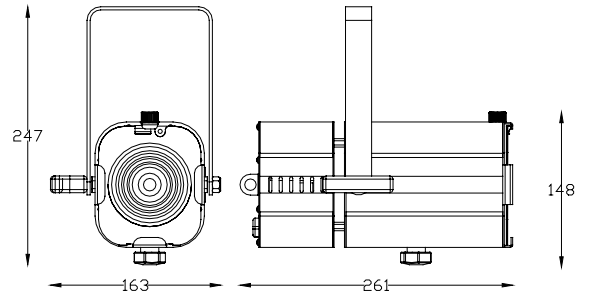

DATI TECNICI - TECHNICAL DATA



100-240 V AC
50/60Hz



50 W

CRI

90



CL I



EXTRUDED ALUMINIUM
AND STEEL SHEET



1,7 Kg

IP

20



EPOXIDIC POWDER

VARIANTI - OPTIONS

Cod.	Color	Temperatura colore Color temperature	Flusso Luminoso Luminous flux	Ottica Optics	€
9812035202	White	3000K	4035 lumen	Fresnel 13° - 88°	
9812034102	White	5000K	4851 lumen	Fresnel 13° - 88°	
9812035204	Grey	3000K	4035 lumen	Fresnel 13° - 88°	
9812034104	Grey	5000K	4851 lumen	Fresnel 13° - 88°	
9812035205	Black	3000K	4035 lumen	Fresnel 13° - 88°	
9812036505	Black	5000K	4851 lumen	Fresnel 13° - 88°	
9812015202	White	3000K	4035 lumen	PC 12° - 95°	
9812014102	White	5000K	4851 lumen	PC 12° - 95°	
9812015204	Grey	3000K	4035 lumen	PC 12° - 95°	
9812014104	Grey	5000K	4851 lumen	PC 12° - 95°	
9812015205	Black	3000K	4035 lumen	PC 12° - 95°	
9812016505	Black	5000K	4851 lumen	PC 12° - 95°	

ACCESSORI - ACCESSORIES

Cod. 0100010005
Paraluce a 4 alette
NERO



Cod. 0100010004
Paraluce a 4 alette
GRIGIO



Cod. 0100010002
Paraluce a 4 alette
BIANCO







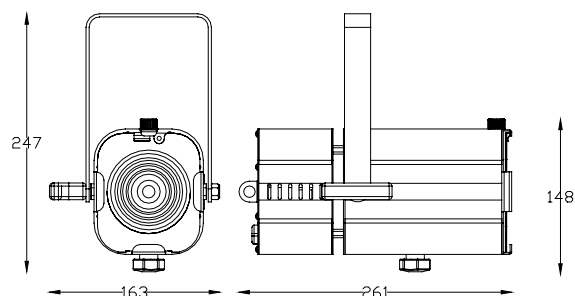

MINI PONY F/PC DMX - DALI

Spot maneggevole dalle dimensioni compatte, con sorgente a LED da 50 W con lente Fresnel o PC, regolazione manuale dello zoom, comandato da segnale DMX e DALI, completo di telaio porta gelatina.

Handy spotlight with small dimensions, with 50W LED source, DMX and DALI dimming control, stand alone functions, Fresnel or PC lens, manual regulation of zoom, complete with color frame.



DATI TECNICI - TECHNICAL DATA

		CRI					IP	
100-240 V AC 50/60Hz	50 W	90	DMX/DALI	CL I	EXTRUDED ALUMINIUM AND STEEL SHEET	1,7 Kg	20	EPOXYDIC POWDER

VARIANTI - OPTIONS

Cod.	Color	Temperatura colore Color temperature	Flusso Luminoso Luminous flux	Ottica Optics	€
9801035202	White	3000K	4035 lumen	Fresnel 13° - 88°	
9801036602	White	5000K	4851 lumen	Fresnel 13° - 88°	
9801036604	Grey	3000K	4035 lumen	Fresnel 13° - 88°	
9801034104	Grey	5000K	4851 lumen	Fresnel 13° - 88°	
9801036605	Black	3000K	4035 lumen	Fresnel 13° - 88°	
9801033005	Black	5000K	4851 lumen	Fresnel 13° - 88°	
9801016602	White	3000K	4035 lumen	PC 12° - 95°	
9801014102	White	5000K	4851 lumen	PC 12° - 95°	
9801015204	Grey	3000K	4035 lumen	PC 12° - 95°	
9801016504	Grey	5000K	4851 lumen	PC 12° - 95°	
9801016605	Black	3000K	4035 lumen	PC 12° - 95°	
9801016505	Black	5000K	4851 lumen	PC 12° - 95°	

ACCESSORI - ACCESSORIES

Cod. 29090006 Sunlite Stick KE1	
Cod. 29090106 Sunlite Stick Gu2	
Cod. 0100010005 Paraluce a 4 alette NERO	
Cod. 0100010004 Paraluce a 4 alette GRIGIO	
Cod. 0100010002 Paraluce a 4 alette BIANCO	



MINI PONY PROFILE

Sagomatore maneggevole dalle dimensioni compatte, con sorgente a LED da 50 W, regolazione manuale dello zoom e del focus, completo di telaio porta gelatina.

Handy profile with small dimensions, with 50W LED source, manual regulation of zoom and focus, complete with color frame.

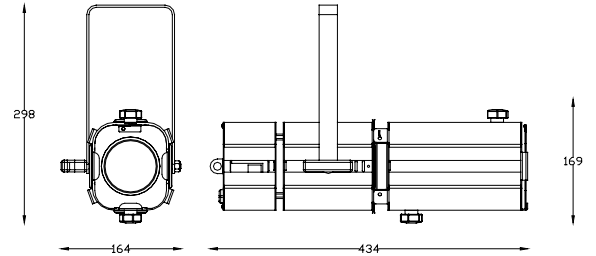

DATI TECNICI - TECHNICAL DATA



100-240 V AC
50/60Hz



50 W

CRI

90



CL I



EXTRUDED ALUMINIUM
AND STEEL SHEET



2,8 Kg

IP

20



EPOXIDIC POWDER

VARIANTI - OPTIONS

Cod.	Color	Temperatura colore Color temperature	Flusso Luminoso Luminous flux	Ottica Optics	€
9812005202	White	3000K	4035 lumen	20° - 38°	
9812004102	White	5000K	4851 lumen	20° - 38°	
9812005204	Grey	3000K	4035 lumen	20° - 38°	
9812004104	Grey	5000K	4851 lumen	20° - 38°	
9812000005	Black	3000K	4035 lumen	20° - 38°	
9812006505	Black	5000K	4851 lumen	20° - 38°	
9812415202	White	3000K	4035 lumen	31° - 46°	
9812414102	White	5000K	4851 lumen	31° - 46°	
9812415204	Grey	3000K	4035 lumen	31° - 46°	
9812414104	Grey	5000K	4851 lumen	31° - 46°	
9812411205	Black	3000K	4035 lumen	31° - 46°	
9812416505	Black	5000K	4851 lumen	31° - 46°	

ACCESSORI - ACCESSORIES

Cod. 1500004500
Diaframma ad iride



Cod. 0801000005
Telaio porta gobo







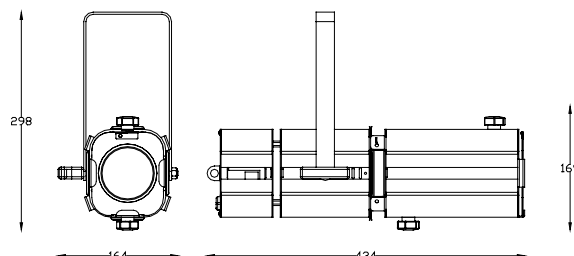

MINI PONY PROFILE DMX - DALI

Sagomatore maneggevole dalle dimensioni compatte, con sorgente a LED da 50 W, controllato da segnale DMX e DALI, regolazione manuale dello zoom e del focus, completo di telaio porta gelatina.

Handy profile with small dimensions, with 50W LED source, DMX and DALI dimming control, stand alone functions, manual regulation of zoom and focus, complete with color frame.



DATI TECNICI - TECHNICAL DATA

		CRI					IP	
100-240 V AC 50/60Hz	50 W	90	DMX/DALI	CL I	EXTRUDED ALUMINIUM AND STEEL SHEET	2,8 Kg	20	EPOXIDIC POWDER

VARIANTI - OPTIONS

Cod.	Color	Temperatura colore Color temperature	Flusso Luminoso Luminous flux	Ottica Optics	€
9812065202	White	3000K	4035 lumen	20° - 38°	
9812006602	White	5000K	4851 lumen	20° - 38°	
9812006604	Grey	3000K	4035 lumen	20° - 38°	
9812016604	Grey	5000K	4851 lumen	20° - 38°	
9812006605	Black	3000K	4035 lumen	20° - 38°	
9812046505	Black	5000K	4851 lumen	20° - 38°	
9812235202	White	3000K	4035 lumen	31° - 46°	
9812234102	White	5000K	4851 lumen	31° - 46°	
9812235204	Grey	3000K	4035 lumen	31° - 46°	
9812234104	Grey	5000K	4851 lumen	31° - 46°	
9812416605	Black	3000K	4035 lumen	31° - 46°	
9812410005	Black	5000K	4851 lumen	31° - 46°	

ACCESSORI - ACCESSORIES

Cod. 29090006
Sunlite Stick KE1



Cod. 29090106
Sunlite Stick Gu2



Cod. 1500004500
Diaframma ad iride



Cod. 0801000005
Telaio porta gobo



MODERNA

Corpo illuminante ad alta luminosità con profilo in alluminio e copertura antiriflesso opale completo di sistema di sospensione.

Lighting fixture with high light output, with aluminium profile and antireflection frosted cover complete with suspending system.

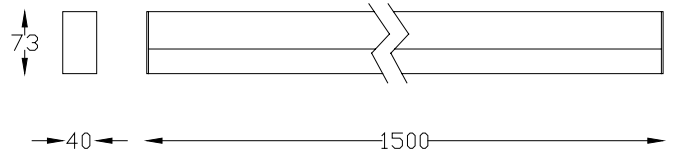

DATI TECNICI - TECHNICAL DATA



24 VDC



38 W

CRI

80



CL III



ALUMINIUM



2 Kg

IP

40

VARIANTI - OPTIONS

Cod.	Temperatura colore Color temperature	Flusso Luminoso Luminous flux	Apertura Fascio Beam angle	€
0083011300	Naturale 4000 K	4840 lumen	120°	

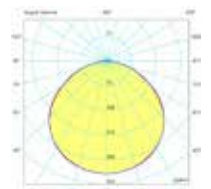



TOD'S



La tendenza sempre più attuale è quella di considerare gli spazi esterni una parte molto importante della casa. Con l'illuminazione giusta puoi trasformare il tuo giardino in un luogo invitante in cui trascorrere ore piacevoli in completo relax.

The trend to consider the external spaces as an important part of the home is getting more and more up-to-date. With the correct lighting you can transform your garden into an inviting place where you can enjoy your stay for hours, completely relaxed.





OUTDOOR



Nelle aree esterne, i proiettori calpestabili permettono di illuminare dal basso elementi architettonici e del giardino creando scenografie suggestive.

In outdoor areas, the walkable spotlights allow to illuminate architectural and garden elements from below, creating evocative scenographies.

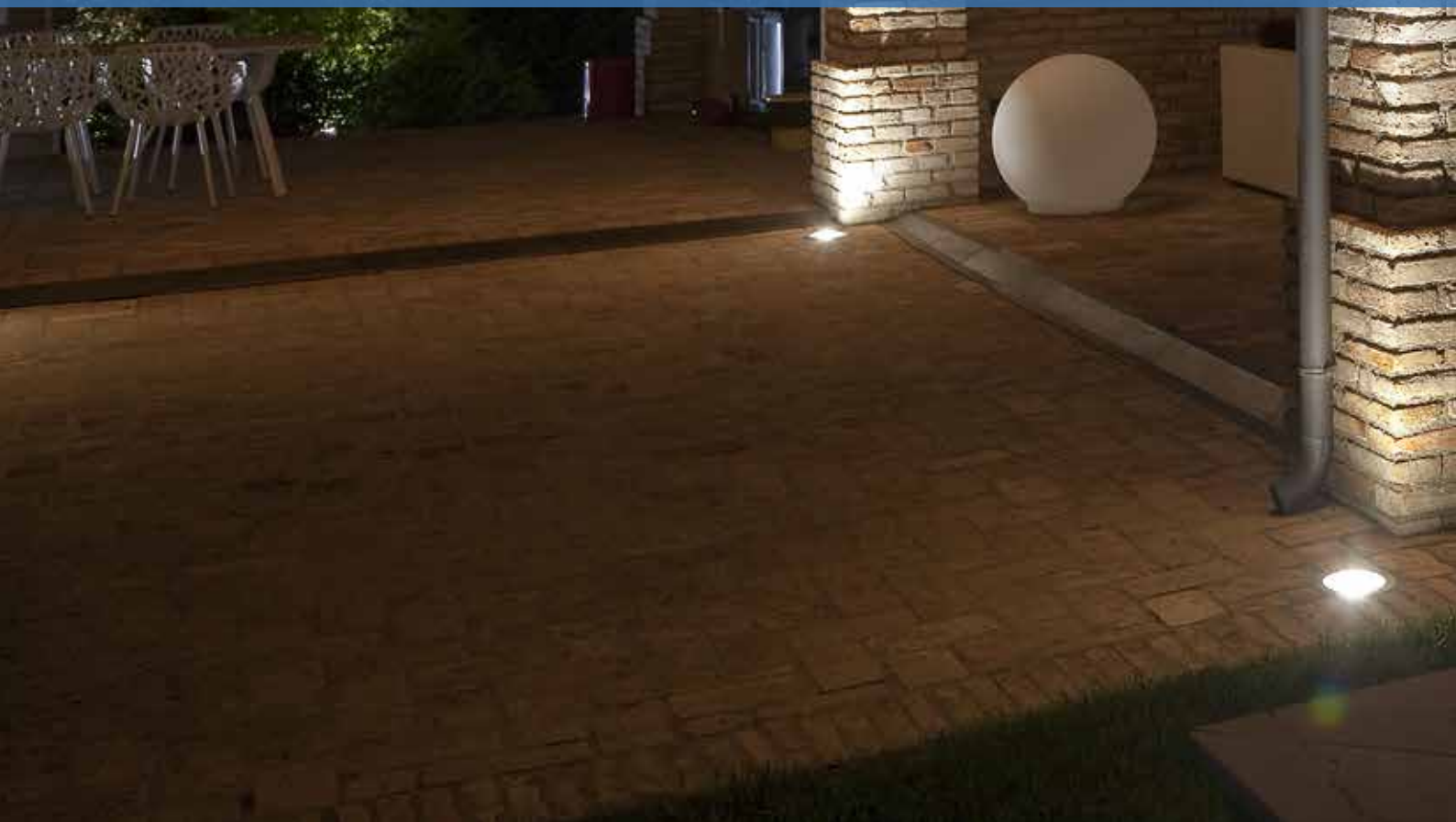

A nighttime photograph of a modern outdoor patio. The scene is illuminated by warm, low-key lighting. In the foreground, a fire pit is filled with large, smooth, light-colored stones. Behind it, a paved patio area features a contemporary outdoor sofa with dark cushions. The patio is supported by two prominent, square stone pillars. Above the patio, a wooden pergola structure with exposed beams and rafters is visible, with some lights integrated into the design. The background shows a dark night sky and some distant lights.

CALPESTABILI

FLOOR RGBW



Proiettore cambia colori a 36 LED ad alta potenza con sistema RGBW per installazione interrata, basculante su +/- 15° carrabile, pilotato da segnale DMX 512 - completo di cavo di alimentazione x 2,5 mt. Alimentazione 230 V AC. Completo di cavo e cassaforma.

36 LEDs colour changer with RGBW system for underground installation, carriageable, driveable with DMX 512 signal. Adjustable light beam direction (+/- 15°). 2,5m connection cable. 230 V AC. Cable and recessed mounting box included.

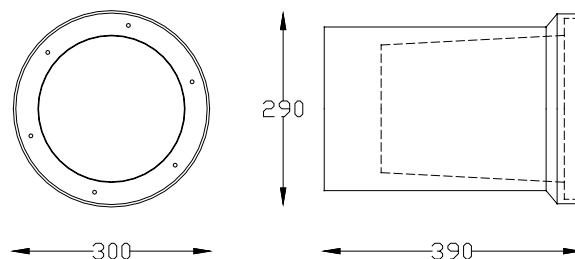

DATI TECNICI - TECHNICAL DATA



230 V AC



73 W



DMX



CL I



DIE-CAST ALUMINIUM
+ INOX STEEL



9 Kg

IP

67



RGBW

VARIANTI - OPTIONS

Cod.	Temperatura colore Color temperature	Flusso Luminoso Luminous flux	Apertura Fascio Beam angle	€
3912615900	RGBW	2844 lumen	80°	
3912535900	RGBW	2844 lumen	35°	
3912625900	RGBW	2844 lumen	19°	
3912385900	RGBW	2844 lumen	15°	

ACCESSORI - ACCESSORIES

Cod. 33161801
Dmx box - controller
dmx per quadro
elettrico



Cod. 4494000000
Telecomando +
ricevitore per dmx box



Cod. 29090106
Sunlite Stick Gu2



Cod. 1000650506
Cassaforma

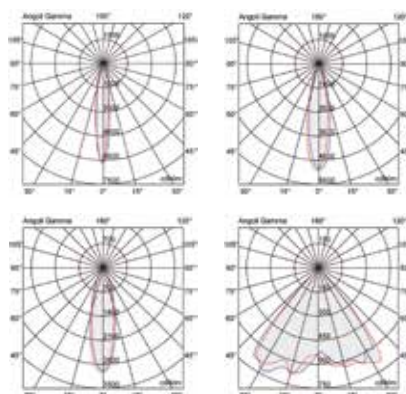

MINI FLOOR RGBW



Proiettore cambia colori a 24 LED ad alta potenza con sistema RGBW per installazione interrata, carrabile - completo di cavo di alimentazione x 2,5 mt. 12V AC, 51 W. Completo di cavo e cassaforma.

24 LEDs colour changer with RGBW system for underground installation, carriageable, driveable with DMX 512-A signal. 6 DMX channels, strobe and rainbow effects at adjustable speed. 12V AC, 51 W. Cable and recessed mounting box included.

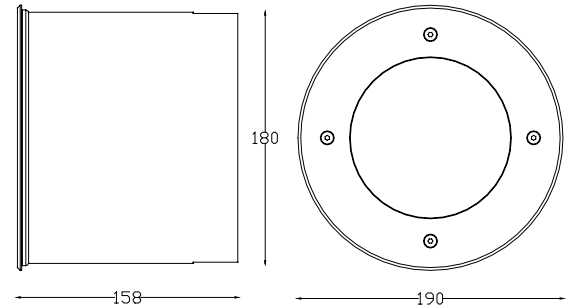

DATI TECNICI - TECHNICAL DATA



12 V AC



51 W



DMX



CL III



ANTICORODAL ANODIZED ALUMINIUM + INOX AISI 316



3,6 Kg

IP

67



RGBW

VARIANTI - OPTIONS

Cod.	Temperatura colore Color temperature	Flusso Luminoso Luminous flux	Apertura Fascio Beam angle	€
3907565900	RGBW	1896 lumen	120°	
3907615900	RGBW	1896 lumen	65°	
3907535900	RGBW	1896 lumen	45°	
3907625900	RGBW	1896 lumen	21°	

ACCESSORI - ACCESSORIES

Cod. 33161801
Dmx box - controller
dmx per quadro
elettrico



Cod. 4494000000
Telecomando +
ricevitore per dmx box



Cod. 29090106
Sunlite Stick Gu2



Cod. 0316170011
Trasformatore IP65
12V AC, 100 W



Cod. 0321170011
Trasformatore IP65
12V AC, 300 W



Cod. 1035700506
Cassaforma

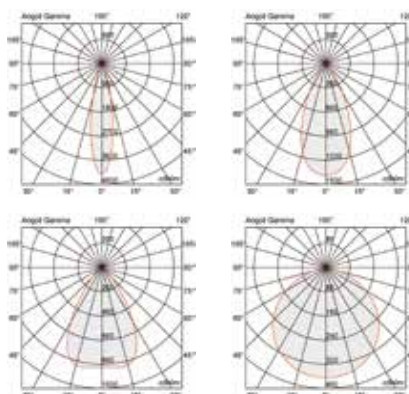

MINI FLOOR WHITE

Proiettori a 16 LED (4 multichip) ad alta potenza a colore fisso per installazione interrata IP67 carrabile. Alimentazione 12 V AC. Completo di cavo e cassaforma.

16 LED's (4 multichip) fixed color 12 V AC projector for underground installation, carriageable, for architectural applications, with 2,5 m x 2x1,5 mm connection cable. Cable and recessed mounting box included.

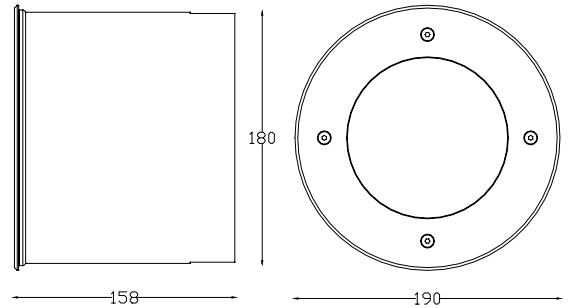

DATI TECNICI - TECHNICAL DATA



VARIANTI - OPTIONS

Cod.	Temperatura colore Color temperature	Flusso Luminoso Luminous flux	Apertura Fascio Beam angle	€
4142566864	Naturale 4000 K	2191 lumen	120°	
4142566890	Caldo 3000 K	2058 lumen	120°	
4142716864	Naturale 4000 K	2191 lumen	65°	
4142716890	Caldo 3000 K	2058 lumen	65°	
4142616864	Naturale 4000 K	2191 lumen	45°	
4142616890	Caldo 3000 K	2058 lumen	45°	
4142626864	Naturale 4000 K	2191 lumen	21°	
4142626890	Caldo 3000 K	2058 lumen	21°	

ACCESSORI - ACCESSORIES

Cod. 0316170011
Trasformatore IP65
12V AC, 100 W



Cod. 0321170011
Trasformatore IP65
12V AC, 300 W



Cod. 1035700506
Cassaforma

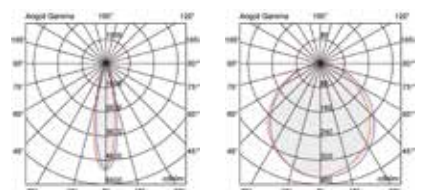

POINT RGBW



Proiettore cambiaco­lori a 4 LED ad alta potenza, con sistema RGBW, controllato da segnale DMX512, per esterno ed interno, interrato. Alimentazione 12 V AC. Completo di cavo e cassaforma.

4 LEDs colour changer with RGBW system for underground installation, carriageable, driveable with DMX 512 signal. Power supply 12 V AC. Cable and recessed mounting box included.

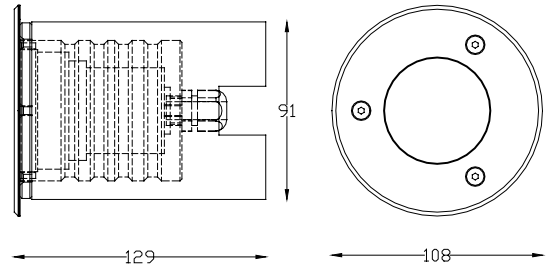

DATI TECNICI - TECHNICAL DATA



12 V AC



10 W



DMX



CL III



ANTICORODAL ANODIZED ALUMINIUM + INOX AISI 316



0,9 Kg

IP

67



RGBW

VARIANTI - OPTIONS

Cod.	Temperatura colore Color temperature	Flusso Luminoso Luminous flux	Apertura Fascio Beam angle	€
6804381294	RGBW	432 lumen	15°	

ACCESSORI - ACCESSORIES

Cod. 33161801
Dmx box - controller
dmx per quadro
elettrico



Cod. 4494000000
Telecomando +
ricevitore per dmx box



Cod. 29090106
Sunlite Stick Gu2



Cod. 0316170011
Trasformatore IP65
12V AC, 100 W



Cod. 0321170011
Trasformatore IP65
12V AC, 300 W



Cod. RML3014
Cassaforma

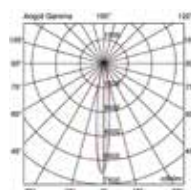

INDOOR

OUTDOOR

STRIP

ROAD

INDUSTRIAL

POINT WHITE



Proiettore a 3 LED ad alta potenza con colore fisso per esterno IP67 da incasso a pavimento. Alimentazione 12 V AC. Completo di cavo e cassaforma.

3 high power fixed colour LEDs IP67 projector for underground installation. Power supply 12 V AC. Cable and recessed mounting box included.

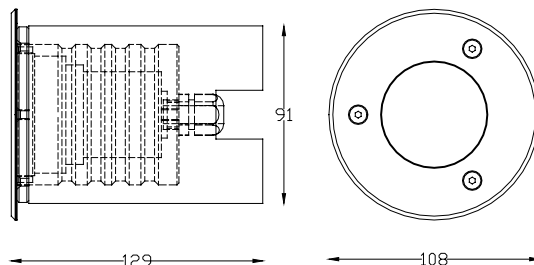

DATI TECNICI - TECHNICAL DATA



12 V AC



8 W

CRI

80



CL III



ANTICORODAL ANODIZED ALUMINIUM + INOX AISI 316



0,9 Kg

IP

67

VARIANTI - OPTIONS

Cod.	Temperatura colore Color temperature	Flusso Luminoso Luminous flux	Apertura Fascio Beam angle	€
680121291	5000K	700 lumen	120°	
6801441264	4000K	660 lumen	120°	
680121290	3000K	585 lumen	120°	
680121210	BLU	-	120°	
6801371291	5000K	700 lumen	15°	
6801371264	4000K	660 lumen	15°	
6801371290	3000K	585 lumen	15°	
6801371210	BLU	-	15°	

ACCESSORI - ACCESSORIES

Cod. 0316170011
Trasformatore IP65
12V AC, 100 W



Cod. 0321170011
Trasformatore IP65
12V AC, 300 W



Cod. RML3014
Cassaforma

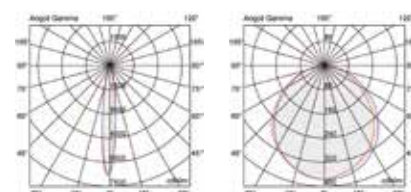

POINT Q WHITE



Proiettore a 3 LED ad alta potenza con colore fisso per esterno IP67 da incasso a pavimento. Alimentazione 12V AC. Completo di cavo e cassaforma.

3 high power fixed colour LEDs IP67 projector for underground installation. Power supply 12V AC. Cable and recessed mounting box included.

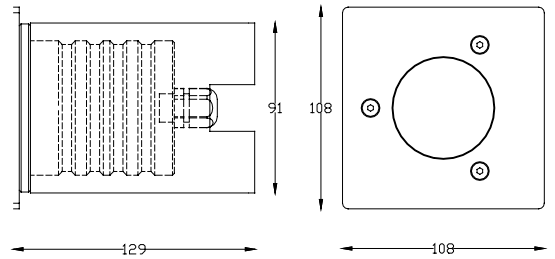

DATI TECNICI - TECHNICAL DATA



12 V AC



8 W

CRI

80



CL III



ANTICORODAL ANODIZED ALUMINIUM + INOX AISI 316



0,9 Kg

IP

67

VARIANTI - OPTIONS

Cod.	Temperatura colore Color temperature	Flusso Luminoso Luminous flux	Apertura Fascio Beam angle	€
6801445791	5000K	700 lumen	120°	
6801445764	4000K	660 lumen	120°	
6801445790	3000K	585 lumen	120°	
6801445710	BLU	-	120°	
6801385791	5000K	700 lumen	15°	
6801385764	4000K	660 lumen	15°	
6801385790	3000K	585 lumen	15°	
6801385710	BLU	-	15°	

ACCESSORI - ACCESSORIES

Cod. 0316170011
Trasformatore IP65
12V AC, 100 W



Cod. 0321170011
Trasformatore IP65
12V AC, 300 W



Cod. RML3014
Cassaforma

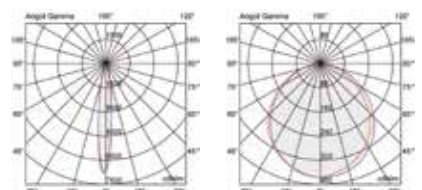

POINT F WHITE



Proiettore a 3 LED ad alta potenza con colore fisso per esterno IP67 da incasso a pavimento con filtro frost. Alimentazione 12 V AC. Completo di cavo e cassaforma.

3 high power fixed colour LEDs IP67 projector for underground installation. Power supply 12 V AC. Cable and recessed mounting box included.

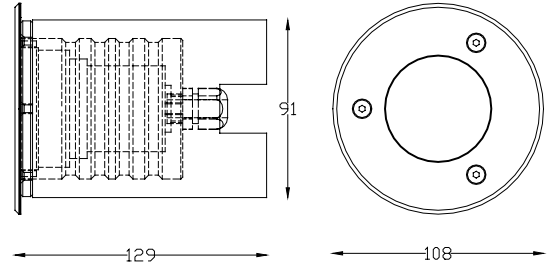

DATI TECNICI - TECHNICAL DATA



12 V AC



8 W

CRI

80



CL III



ANTICORODAL ANODIZED ALUMINIUM + INOX AISI 316



0,9 Kg

IP

67

VARIANTI - OPTIONS

Cod.	Temperatura colore Color temperature	Flusso Luminoso Luminous flux	Apertura Fascio Beam angle	€
6801601291	5000K	700 lumen	FROST	
6801601264	4000K	660 lumen	FROST	
6801601290	3000K	585 lumen	FROST	
6801601210	BLU	-	FROST	

ACCESSORI - ACCESSORIES

Cod. 0316170011
Trasformatore IP65
12V AC, 100 W



Cod. 0321170011
Trasformatore IP65
12V AC, 300 W



Cod. RML3014
Cassaforma



POINT QF WHITE



Proiettore a 3 LED ad alta potenza con colore fisso per esterno IP67 da incasso a pavimento con cornice Quadrata e filtro frost. Alimentazione 12 V AC. Completo di cavo e cassaforma.

3 high power fixed colour LEDs IP67 projector for underground installation. Power supply 12 V AC. Cable and recessed mounting box included.

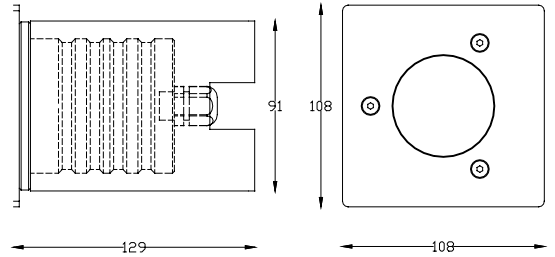

DATI TECNICI - TECHNICAL DATA



12 V AC



8 W

CRI

80



CL III



ANTICORODAL ANODIZED ALUMINIUM + INOX AISI 316



0,9 Kg

IP

67

VARIANTI - OPTIONS

Cod.	Temperatura colore Color temperature	Flusso Luminoso Luminous flux	Apertura Fascio Beam angle	€
6801605791	5000K	700 lumen	FROST	
6801605764	4000K	660 lumen	FROST	
6801605790	3000K	585 lumen	FROST	
6801605710	BLU	-	FROST	

ACCESSORI - ACCESSORIES

Cod. 0316170011
Trasformatore IP65
12V AC, 100 W



Cod. 0321170011
Trasformatore IP65
12V AC, 300 W



Cod. RML3014
Cassaforma



INDOOR

OUTDOOR

STRIP

ROAD

INDUSTRIAL

MINI POINT WHITE

Proiettore a 1 LED ad alta potenza con colore fisso per esterno IP67 da incasso a pavimento. Alimentazione 12 V AC. Completo di cavo e cassaforma.

1 high power fixed colour LEDs IP67 projector for underground installation. Power supply 12 V AC. Cable and recessed mounting box included.

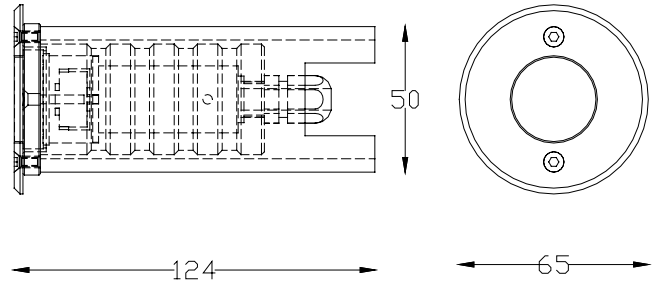

DATI TECNICI - TECHNICAL DATA



12 V AC



4.6 W

CRI

80



CL III



ANTICORODAL ANODIZED ALUMINIUM + INOX AISI 316



0,43 Kg

IP

67

VARIANTI - OPTIONS

Cod.	Temperatura colore Color temperature	Flusso Luminoso Luminous flux	Apertura Fascio Beam angle	€
6847750091	5000K	234 lumen	80°	
6847750064	4000K	220 lumen	80°	
6847750090	3000K	195 lumen	80°	
6847530091	5000K	234 lumen	35°	
6847530064	4000K	220 lumen	35°	
6847530090	3000K	195 lumen	35°	
6847620091	5000K	234 lumen	19°	
6847620064	4000K	220 lumen	19°	
6847620090	3000K	195 lumen	19°	

ACCESSORI - ACCESSORIES

Cod. 0316170011
Trasformatore IP65
12V AC, 100 W



Cod. 0321170011
Trasformatore IP65
12V AC, 300 W



Cod. 1010000506
Cassaforma

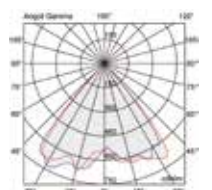
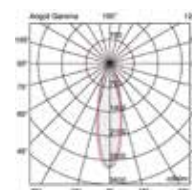
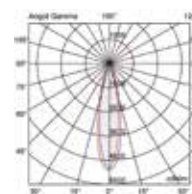

MINI POINT F WHITE



Proiettore a 1 LED ad alta potenza con colore fisso per esterno IP67 da incasso a pavimento con filtro frost. Alimentazione 12 V AC. Completo di cavo e cassaforma.

1 high power fixed colour LEDs IP67 projector for underground installation with frost filter. Power supply 12 V AC. Cable and recessed mounting box included.

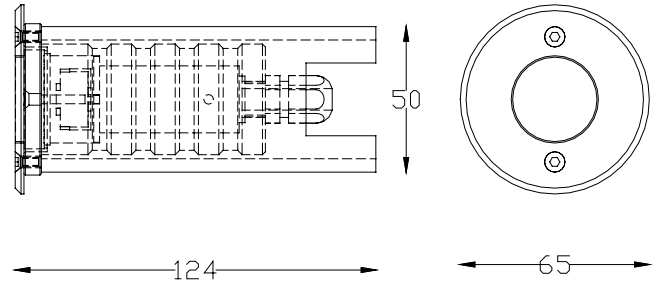

DATI TECNICI - TECHNICAL DATA



12 V AC



4.6 W

CRI

80



CL III



ANTICORRODAL ANODIZED
ALUMINIUM + INOX AISI 316



0,43 Kg

IP

67

VARIANTI - OPTIONS

Cod.	Temperatura colore Color temperature	Flusso Luminoso Luminous flux	Apertura Fascio Beam angle	€
6847600091	5000K	234 lumen	FROST	
6804600064	4000K	220 lumen	FROST	
6804600090	3000K	195 lumen	FROST	

ACCESSORI - ACCESSORIES

Cod. 0316170011
Trasformatore IP65
12V AC, 100 W



Cod. 0321170011
Trasformatore IP65
12V AC, 300 W



Cod. 1010000506
Cassaforma

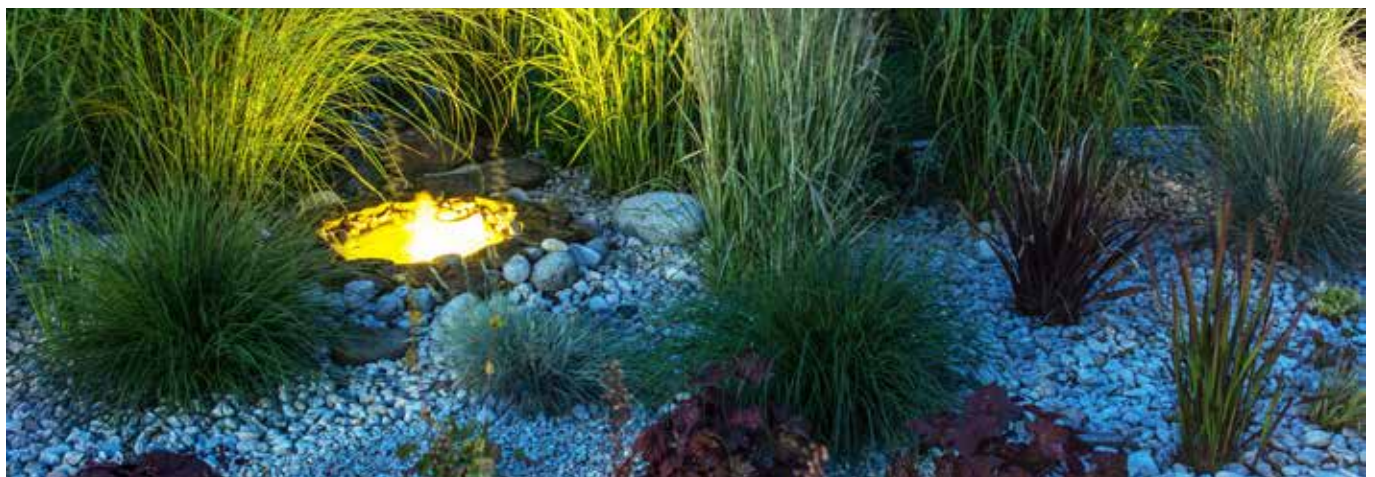

INDOOR

OUTDOOR

STRIP

ROAD

INDUSTRIAL

POINT L1 WHITE

Proiettore a 3 LED ad alta potenza con colore fisso per esterno IP67 da incasso a pavimento con 1 uscita luce laterale. Alimentazione 12 V AC. Completo di cavo e cassaforma.

3 high power fixed colour LEDs with 1 side light output projector, IP67 for underground installation. Power supply 12 V AC. Cable and recessed mounting box included

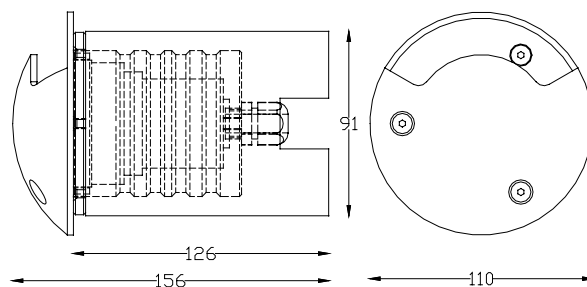

DATI TECNICI - TECHNICAL DATA



12 V AC



8 W

CRI

80



CL III



ANTICORODAL ANODIZED
ALUMINIUM + ALUMINIUM



0,9 Kg

IP

67

VARIANTI - OPTIONS

Cod.	Temperatura colore Color temperature	Flusso Luminoso Luminous flux	Apertura Fascio Beam angle	€
6801111292	5000K	700 lumen	1x100°	
6801111264	4000K	660 lumen	1x100°	
6800121290	3000K	585 lumen	1x100°	
6801111210	BLU	-	1x100°	

ACCESSORI - ACCESSORIES

Cod. 0316170011
Trasformatore IP65
12V AC, 100 W



Cod. 0321170011
Trasformatore IP65
12V AC, 300 W



Cod. RML3014
Cassaforma



POINT L2 WHITE



Proiettore a 3 LED ad alta potenza con colore fisso per esterno IP67 da incasso a pavimento con 2 uscite luce laterali. Alimentazione 12 V AC. Completo di cavo e cassaforma.

3 high power fixed colour LEDs with 2 sides light output projector, IP67 for underground installation. Power supply 12 V AC. Cable and recessed mounting box included

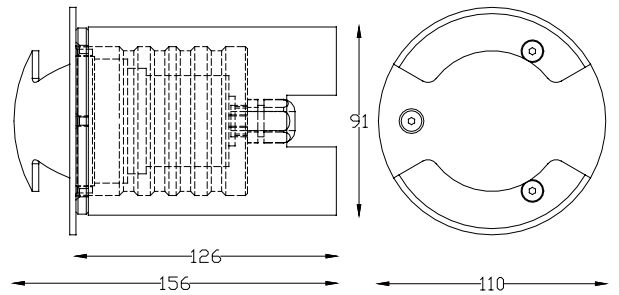

DATI TECNICI - TECHNICAL DATA



12 V AC



8 W

CRI

80



CL III



ANTICORODAL ANODIZED
ALUMINIUM + ALUMINIUM



0,9 Kg

IP

67

VARIANTI - OPTIONS

Cod.	Temperatura colore Color temperature	Flusso Luminoso Luminous flux	Apertura Fascio Beam angle	€
6801121292	5000K	700 lumen	2x100°	
6801121264	4000K	660 lumen	2x100°	
6801121290	3000K	585 lumen	2x100°	
6801121210	BLU	-	2x100°	

ACCESSORI - ACCESSORIES

Cod. 0316170011
Trasformatore IP65
12V AC, 100 W



Cod. 0321170011
Trasformatore IP65
12V AC, 300 W



Cod. RML3014
Cassaforma



INDOOR

OUTDOOR

STRIP

ROAD

INDUSTRIAL



I dettagli, il disegno della luce contribuiscono in modo significativo ad aumentare il valore estetico di una casa o di un palazzo.

The details, the design of light contribute significantly to increase the aesthetic value of a house or a building.

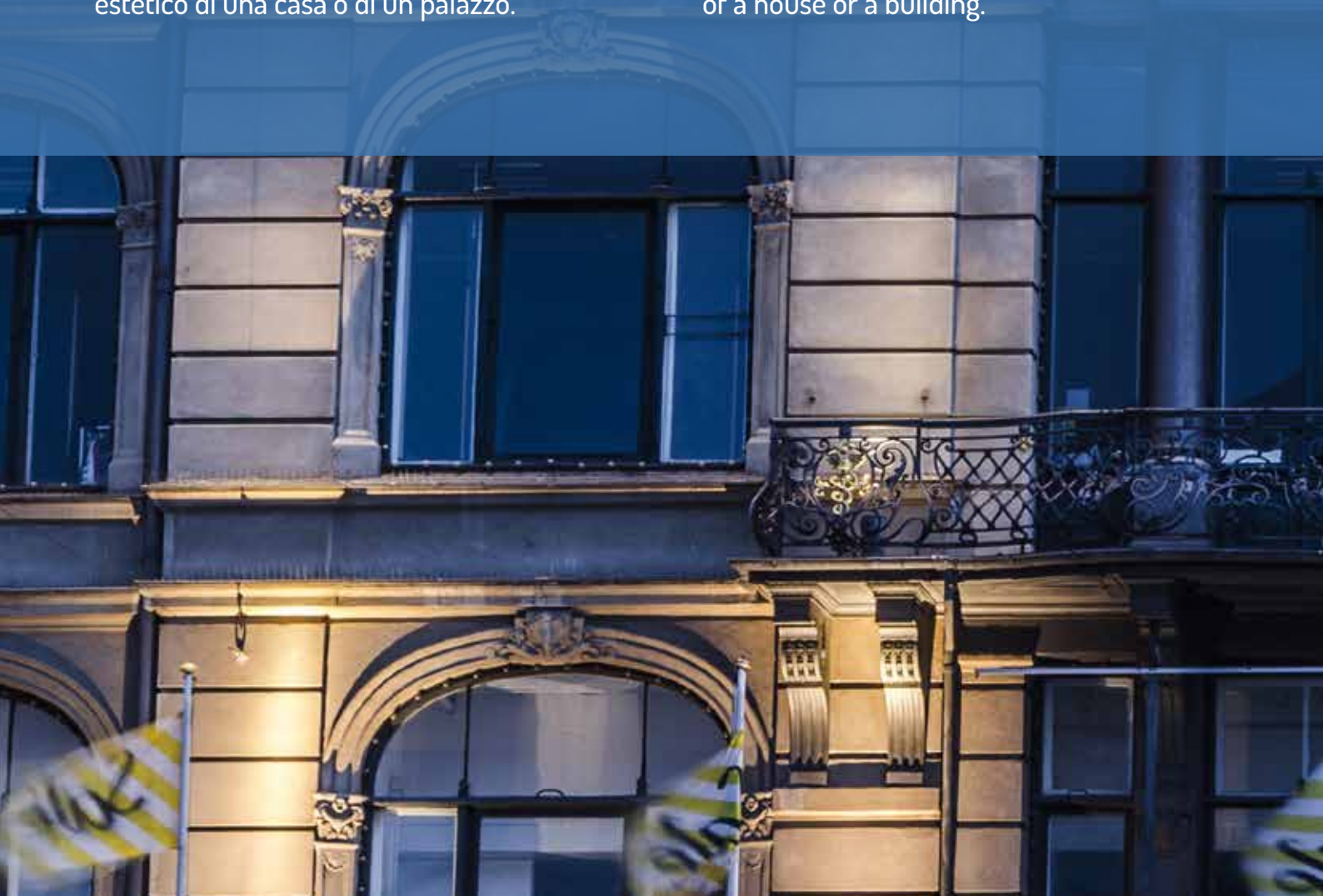



DETTAGLI

RIGA WHITE

Proiettore a 3 LED ad alta potenza con colore fisso per esterno IP65 orientabile. Alimentazione 12V AC. Completo di cavo.

3 high power fixed colour LEDs fixture for outdoor use with adjustable stirrup. IP65 protection rate. Cable included.

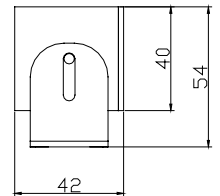
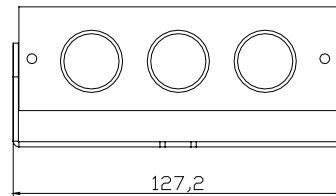
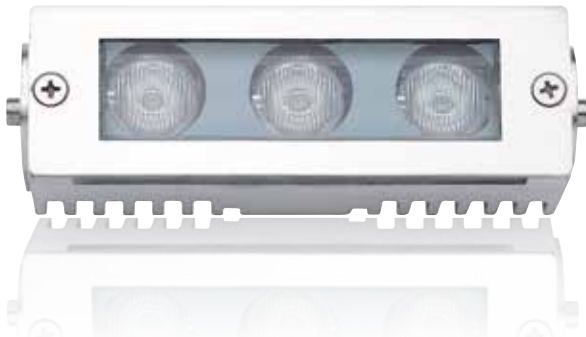

DATI TECNICI - TECHNICAL DATA



12 V AC



7 W

CRI

80



CL III



ANTICORODAL ANODIZED ALUMINIUM + INOX AISI 316



0,5 Kg

IP

65

VARIANTI - OPTIONS

Cod.	Temperatura colore Color temperature	Flusso Luminoso Luminous flux	Apertura Fascio Beam angle	€
6901601291	5000K	700 lumen	80°	
6901441264	4000K	660 lumen	80°	
6901601290	3000K	585 lumen	80°	
6901601210	BLU	-	80°	
6901391291	5000K	700 lumen	40°x20°	
6901211264	4000K	660 lumen	40°x20°	
6901391290	3000K	585 lumen	40°x20°	
6901391210	BLU	-	40°x20°	
6901371291	5000K	700 lumen	15°	
6901371264	4000K	660 lumen	15°	
6901371290	3000K	585 lumen	15°	
6901371210	BLU	-	15°	

ACCESSORI - ACCESSORIES

Cod. 0316170011
Trasformatore IP65
12V AC, 100 W



Cod. 0321170011
Trasformatore IP65
12V AC, 300 W



Cod. 02804460 02
Picchetto per RIGA

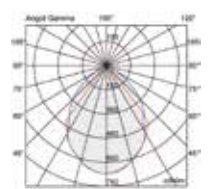
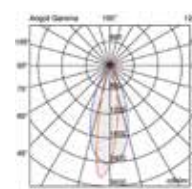
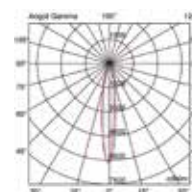

RIGA IN WHITE

Proiettore a 3 LED ad alta potenza con colore fisso da incasso per esterno IP67. Alimentazione 12V AC. Completo di cavo e cassaforma.

3 high power fixed colour LEDs recessed fixture for outdoor use. IP67 protection rate. Cable and recessed mounting box included.

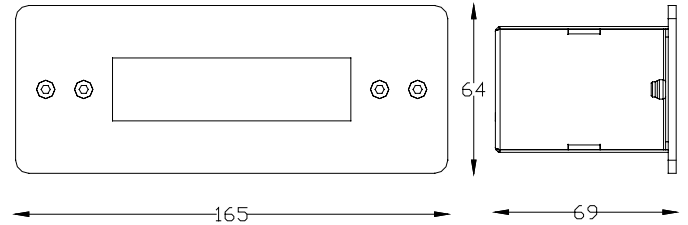

DATI TECNICI - TECHNICAL DATA



12 V AC



7 W

CRI

80



CL III



ANTICORODAL ANODIZED
ALUMINIUM + INOX AISI 316



0,85 Kg

IP

67

VARIANTI - OPTIONS

Cod.	Temperatura colore Color temperature	Flusso Luminoso Luminous flux	Apertura Fascio Beam angle	€
6901213192	5000K	700 lumen	80°	
6901213164	4000K	660 lumen	80°	
6901213190	3000K	585 lumen	80°	
6901213110	BLU	-	80°	
6901393191	5000K	700 lumen	40°x20°	
6901443164	4000K	660 lumen	40°x20°	
6901393190	3000K	585 lumen	40°x20°	
6901393110	BLU	-	40°x20°	
6901373192	5000K	700 lumen	15°	
6901373164	4000K	660 lumen	15°	
6901373190	3000K	585 lumen	15°	
6901373110	BLU	-	15°	

ACCESSORI - ACCESSORIES

Cod. 0316170011
Trasformatore IP65
12V AC, 100 W



Cod. 0321170011
Trasformatore IP65
12V AC, 300 W



Cod. 1000440002
Cassaforma

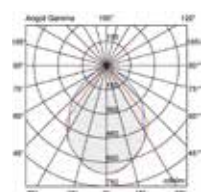
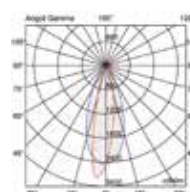
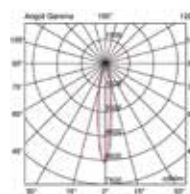
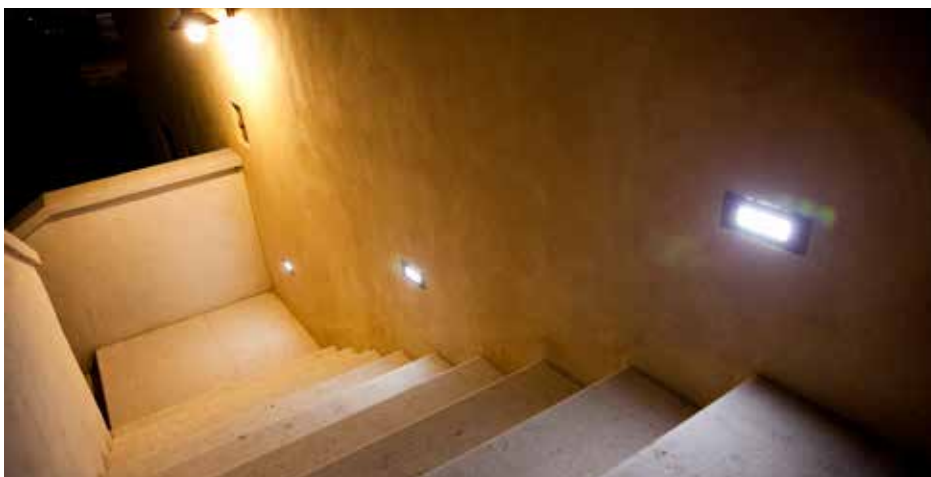

RIGA IN F WHITE

Proiettore a 3 LED ad alta potenza con colore fisso da incasso per esterno IP67 con filtro frost. Alimentazione 12V AC. Completo di cavo e cassaforma.

3 high power fixed colour LEDs recessed fixture for outdoor use with frost filter. IP67 protection rate. Cable and recessed mounting box included.

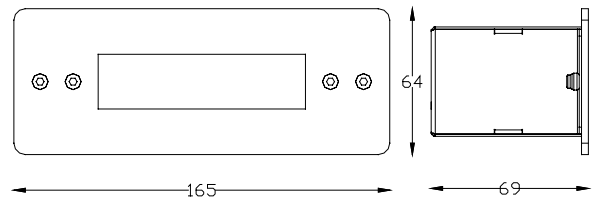

DATI TECNICI - TECHNICAL DATA



12 V AC



7 W

CRI

80



CL III



ANTICORODAL ANODIZED
ALUMINIUM + INOX AISI 316



0,85 Kg

IP

67

VARIANTI - OPTIONS

Cod.	Temperatura colore Color temperature	Flusso Luminoso Luminous flux	Apertura Fascio Beam angle	€
6901603191	5000K	700 lumen	FROST	
6901603164	4000K	660 lumen	FROST	
6901603190	3000K	585 lumen	FROST	
6901603110	BLU	-	FROST	

ACCESSORI - ACCESSORIES

Cod. 0316170011
Trasformatore IP65
12V AC, 100 W



Cod. 0321170011
Trasformatore IP65
12V AC, 300 W



Cod. 1000440002
Cassaforma



FUSION WHITE





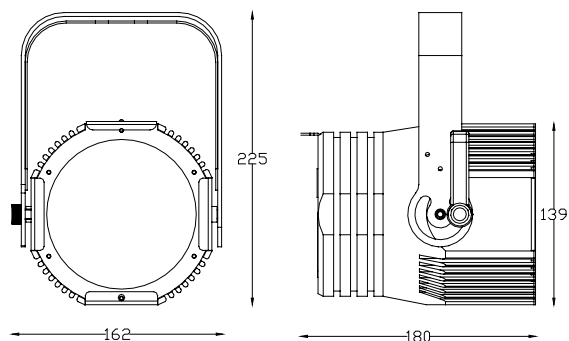

Proiettore a colore fisso per esterno IP65 a 16 LED (4 multichip) ad alta potenza. Consumo massimo 37W. Completo di cavo.

16 high power LEDs (4 multichip) fixture for outdoor installation IP65. Maximum consumption 37W. Cable included.



DATI TECNICI - TECHNICAL DATA

		CRI				IP
220-240 V AC	37 W	80	CL I	ALUMINIUM	4,1 Kg	65

VARIANTI - OPTIONS

Cod.	Temperatura colore Color temperature	Flusso Luminoso Luminous flux	Apertura Fascio Beam angle	€
7109564104	5000K	3880 lumen	120°	
7109566504	4000K	3720 lumen	120°	
7109565204	3000K	3120 lumen	120°	
7109564304	BLU	-	120°	
7109714104	5000K	3880 lumen	65°	
7109716504	4000K	3720 lumen	65°	
7109715204	3000K	3120 lumen	65°	
7109714304	BLU	-	65°	
7109544104	5000K	3880 lumen	45°	
7109546504	4000K	3720 lumen	45°	
7109545204	3000K	3120 lumen	45°	
7109544304	BLU	-	45°	
7109624104	5000K	3880 lumen	21°	
7109626504	4000K	3720 lumen	21°	
7109625204	3000K	3120 lumen	21°	
7109624304	BLU	-	21°	

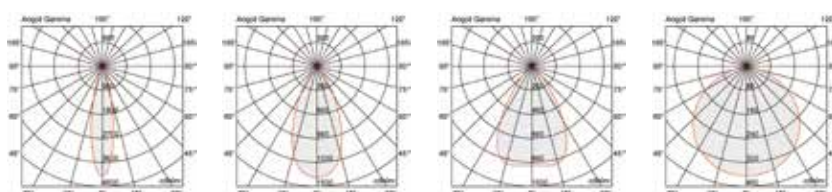

FUSION RGBW ECO





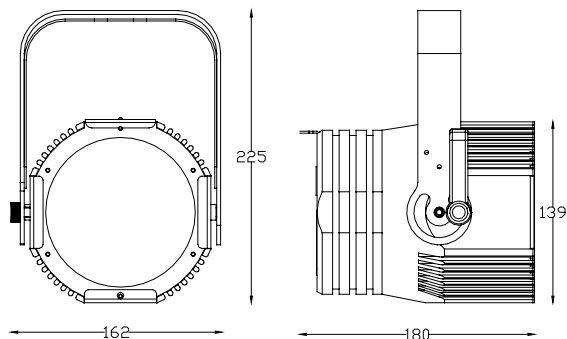

Proiettore cambiadori a 24 LED ad alta potenza pilotato da segnale DMX con sistema RGBW e regolazione dimmer. Alimentazione 230 V AC. Completo di cavo.

24 LED colour changer with RGBW system for indoor and outdoor use driveable with DMX 512-A signal. 6 DMX channels, strobe and rainbow effects at adjustable speed. Cable included.



DATI TECNICI - TECHNICAL DATA

		CRI					IP	
220-240 V AC	51 W	80	DMX	CL I	ALUMINIUM	4,3 Kg	65	RGBW

VARIANTI - OPTIONS

Cod.	Temperatura colore Color temperature	Flusso Luminoso Luminous flux	Apertura Fascio Beam angle	€
7111561604	RGBW	1896 lumen	120°	
7111711604	RGBW	1896 lumen	65°	
7111541604	RGBW	1896 lumen	45°	
7111621604	RGBW	1896 lumen	21°	

ACCESSORI - ACCESSORIES

Cod. 33161801
Dmx box - controller
dmx per quadro
elettrico



Cod. 29090106
Sunlite Stick Gu2



Cod. 29090006
Sunlite Stick KE1



Cod. 29090306
Sunlite Stick DE3



MICRO WHITE



Proiettore a 3 LED ad alta potenza con colore fisso per esterno IP65 orientabile. Alimentazione 12 V AC. Cavo incluso.

3 high power fixed colour LEDs fixture for outdoor use with adjustable stirrup. IP65 protection rate. Cable included.

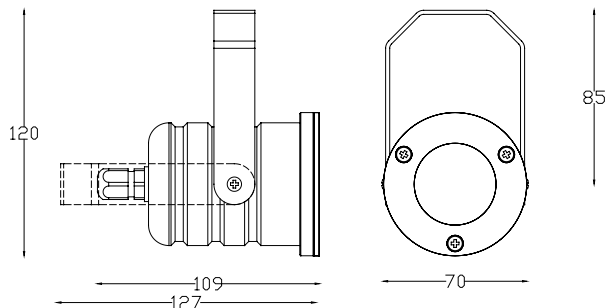

DATI TECNICI - TECHNICAL DATA



12 V AC



8 W

CRI

80



CL III



ANTICORODAL ANODIZED ALUMINIUM + INOX AISI 316



0,60 Kg

IP

65

VARIANTI - OPTIONS

Cod.	Temperatura colore Color temperature	Flusso Luminoso Luminous flux	Apertura Fascio Beam angle	€
8904534104	5000K	700 lumen	120°	
8904564104	4000K	660 lumen	120°	
8904564190	3000K	585 lumen	120°	
8904564304	BLU	-	120°	
8904384104	5000K	700 lumen	15°	
8904386504	4000K	660 lumen	15°	
8904385204	3000K	585 lumen	15°	
8904384304	BLU	-	15°	

ACCESSORI - ACCESSORIES

Cod. 0316170011
Trasformatore IP65
12V AC, 100 W



Cod. 0321170011
Trasformatore IP65
12V AC, 300 W

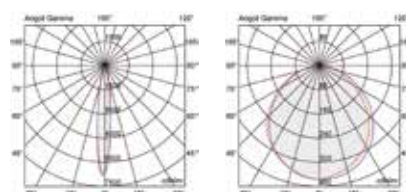

MICRO RGBW

Proiettore cambiacolore a 1 LED full color da 10w, 12 V AC con sistema RGBW, per esterno, fascio stretto. Alimentazione 12 V AC. Completo di cavo.

1 x 10 W full color LED colour changer with RGBW system for indoor and outdoor use driveable with DMX 512-A signal. DMX channels, strobe and rainbow effects at adjustable speed. Cable included.

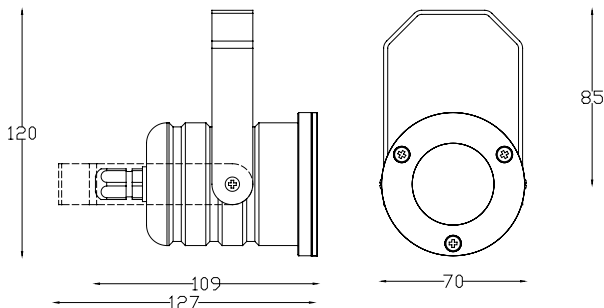

DATI TECNICI - TECHNICAL DATA



12 V AC



10 W

CRI

80



CL III



ALUMINIUM



0,60 Kg

IP

65



RGBW

VARIANTI - OPTIONS

Cod.	Temperatura colore Color temperature	Flusso Luminoso Luminous flux	Apertura Fascio Beam angle	€
8904383904	RGBW	432 lumen	30°	

ACCESSORI - ACCESSORIES

Cod. 0316170011
Trasformatore IP65
12V AC, 100 W



€ 124,00

Cod. 0321170011
Trasformatore IP65
12V AC, 300 W



€ 194,00

Cod. 33161801
Dmx box - controller
dmx per quadro
elettrico



€ 650,00

Cod. 4494000000
Telecomando +
ricevitore per dmx box



€ 225,00

Cod. 29090106
Sunlite Stick Gu2



€ 495,56

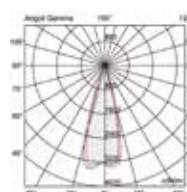

MONO T



Proiettore a LED ad alta Potenza per montaggio a plafone su parete per esterni ed interni IP65 con singola uscita luce. Alimentazione 230 V AC.

High power LED fixture surface-mounted on the wall for indoor and outdoor IP65 with single light output. 230 V AC.

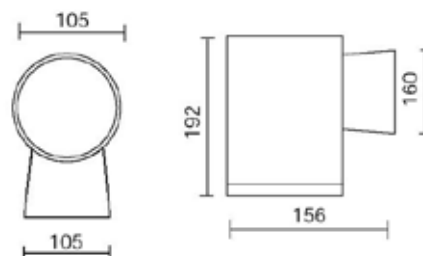

DATI TECNICI - TECHNICAL DATA



230 V AC



72 W

CRI

80



CL I



DIE-CAST ALUMINIUM



1,7 Kg

IP

65

VARIANTI - OPTIONS

Cod.	Colore Colors	Temperatura colore Color temperature	Flusso Luminoso Luminous flux	Apertura Fascio Beam angle	€
E5550MLBC25	Bianco / White	3000K	770 lumen	25°	
E5550MLBC40	Bianco / White	3000K	770 lumen	40°	
E5551MLBC25	Nero / Black	3000K	770 lumen	25°	
E5551MLBC40	Nero / Black	3000K	770 lumen	40°	
E5552MLBC25	Grigio / Grey	3000K	770 lumen	25°	
E5552MLBC40	Grigio / Grey	3000K	770 lumen	40°	
E5550MLBN25	Bianco / White	4000K	860 lumen	25°	
E5550MLBN40	Bianco / White	4000K	860 lumen	40°	
E5551MLBN25	Nero / Black	4000K	860 lumen	25°	
E5551MLBN40	Nero / Black	4000K	860 lumen	40°	
E5552MLBN25	Grigio / Grey	4000K	860 lumen	25°	
E5552MLBN40	Grigio / Grey	4000K	860 lumen	40°	

INDOOR

OUTDOOR

STRIP

ROAD

INDUSTRIAL

DOUBLE T



Proiettore a LED ad alta Potenza per montaggio a plafone su parete per esterni ed interni IP65 con doppia uscita luce. Alimentazione 230 V AC.

High power LED fixture surface-mounted on the wall for indoor and outdoor IP65 with double light output. 230 V AC.

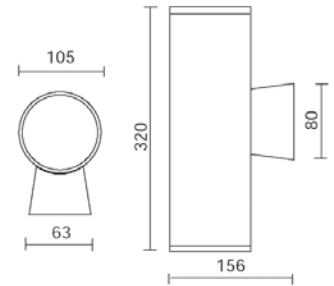

DATI TECNICI - TECHNICAL DATA



230 V AC



13 W

CRI

80



CL I



DIE-CAST ALUMINIUM



2 Kg

IP

65

VARIANTI - OPTIONS

Cod.	Colore Colors	Temperatura colore Color temperature	Flusso Luminoso Luminous flux	Apertura Fascio Beam angle	€
E5553LBC10	Bianco / White	3000K	750 lumen	10°	
E5553LBC30	Bianco / White	3000K	750 lumen	30°	
E5554LBC10	Nero / Black	3000K	750 lumen	10°	
E5554LBC30	Nero / Black	3000K	750 lumen	30°	
E5555LBC10	Grigio / Grey	3000K	750 lumen	10°	
E5555LBC30	Grigio / Grey	3000K	750 lumen	30°	
E5553LBN10	Bianco / White	4000K	760 lumen	10°	
E5553LBN30	Bianco / White	4000K	760 lumen	30°	
E5554LBN10	Nero / Black	4000K	760 lumen	10°	
E5554LBN30	Nero / Black	4000K	760 lumen	30°	
E5555LBN10	Grigio / Grey	4000K	760 lumen	10°	
E5555LBN30	Grigio / Grey	4000K	760 lumen	30°	

MONO Q



Proiettore a LED ad alta Potenza per montaggio a plafone su parete per esterni ed interni IP65 con singola uscita luce. Alimentazione 230 V AC.

High power LED fixture surface-mounted on the wall for indoor and outdoor IP65 with single light output. 230 V AC.

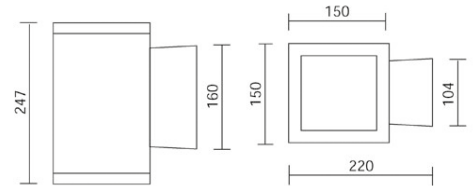

DATI TECNICI - TECHNICAL DATA



230 V AC



72 W

CRI

80



CL I



DIE-CAST ALUMINIUM



3 Kg

IP

65

VARIANTI - OPTIONS

Cod.	Colore Colors	Temperatura colore Color temperature	Flusso Luminoso Luminous flux	Apertura Fascio Beam angle	€
E5360MLBC25	Bianco / White	3000K	770 lumen	25°	
E5360MLBC40	Bianco / White	3000K	770 lumen	40°	
E5361MLBC25	Nero / Black	3000K	770 lumen	25°	
E5361MLBC40	Nero / Black	3000K	770 lumen	40°	
E5362MLBC25	Grigio / Grey	3000K	770 lumen	25°	
E5362MLBC40	Grigio / Grey	3000K	770 lumen	40°	
E5360MLBN25	Bianco / White	4000K	860 lumen	25°	
E5360MLBN40	Bianco / White	4000K	860 lumen	40°	
E5361MLBN25	Nero / Black	4000K	860 lumen	25°	
E5361MLBN40	Nero / Black	4000K	860 lumen	40°	
E5362MLBN25	Grigio / Grey	4000K	860 lumen	25°	
E5362MLBN40	Grigio / Grey	4000K	860 lumen	40°	

DOUBLE Q



Proiettore a LED ad alta Potenza per montaggio a plafone su parete per esterni ed interni IP65 con doppia uscita luce. Alimentazione 230 V AC.

High power LED fixture surface-mounted on the wall for indoor and outdoor IP65 with double light output. 230 V AC.

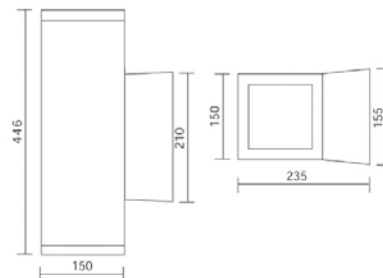

DATI TECNICI - TECHNICAL DATA



230 V AC



13,4 W

CRI

80



CL I



DIE-CAST ALUMINIUM



3,2 Kg

IP

65

VARIANTI - OPTIONS

Cod.	Colore Colors	Temperatura colore Color temperature	Flusso Luminoso Luminous flux	Apertura Fascio Beam angle	€
E5363MLBC25	Bianco / White	3000K	1540 lumen	25°	
E5363MLBC40	Bianco / White	3000K	1540 lumen	40°	
E5364MLBC25	Nero / Black	3000K	1540 lumen	25°	
E5364MLBC40	Nero / Black	3000K	1540 lumen	40°	
E5365MLBC25	Grigio / Grey	3000K	1540 lumen	25°	
E5365MLBC40	Grigio / Grey	3000K	1540 lumen	40°	
E5363MLBN25	Bianco / White	4000K	1720 lumen	25°	
E5363MLBN40	Bianco / White	4000K	1720 lumen	40°	
E5364MLBN25	Nero / Black	4000K	1720 lumen	25°	
E5364MLBN40	Nero / Black	4000K	1720 lumen	40°	
E5365MLBN25	Grigio / Grey	4000K	1720 lumen	25°	
E5365MLBN40	Grigio / Grey	4000K	1720 lumen	40°	

RIQUADRO MICROLED

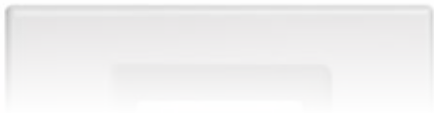

Proiettore a LED ad alta potenza con colore fisso da incasso per esterno IP65. Alimentazione 230 V AC.

High power fixed colour LED recessed fixture for outdoor use. IP65 protection rate. 230 V AC.

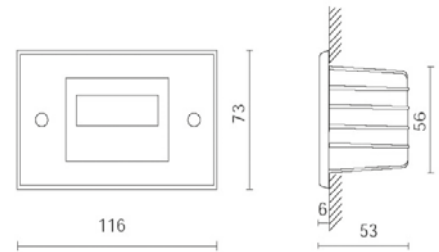

DATI TECNICI - TECHNICAL DATA



230V 50/60Hz



5,5 W

CRI

80



CL II



DIE-CAST ALUMINIUM



0,5 Kg

IP

65

VARIANTI - OPTIONS

Cod.	Colore Colors	Temperatura colore Color temperature	Flusso Luminoso Luminous flux	Apertura Fascio Beam angle	€
E908-LBC	Grigio / Grey	3000K	240 lumen	40°	

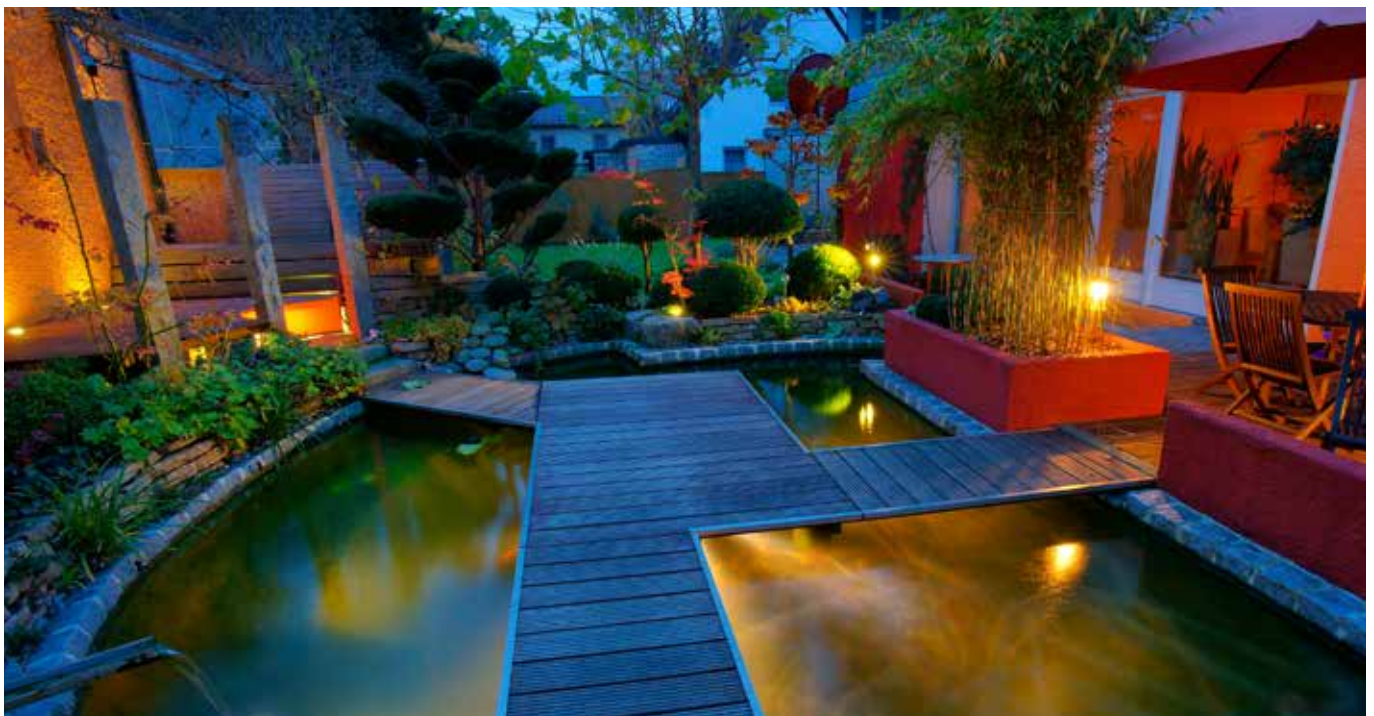

INDOOR

OUTDOOR

STRIP

ROAD

INDUSTRIAL

RIQUADRO GR

Proiettore a LED ad alta potenza con colore fisso da incasso per esterno IP65. Alimentazione 230 V AC.

High power fixed colour LED recessed fixture for outdoor use. IP65 protection rate. 230 V AC.

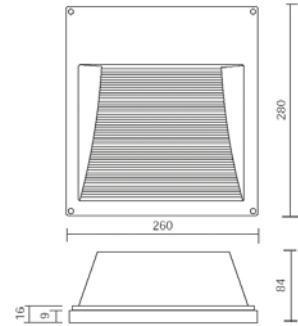

DATI TECNICI - TECHNICAL DATA



220-240V
50/60Hz



8,2W

CRI

80



CL I



DIE-CAST ALUMINIUM



3,5 Kg

IP

65

VARIANTI - OPTIONS

Cod.	Colore Colors	Temperatura colore Color temperature	Flusso Luminoso Luminous flux	Apertura Fascio Beam angle	€
E5347-LBC	Grigio / Grey	3000K	600 lumen	Asimmetrico/ Asymmetric	



PLAFONIERA LED A PARETE

Proiettore a LED per montaggio a parete o a soffitto per esterni ed interni IP44 Alimentazione 230 V AC.

LED fixture for wall or ceiling mounting for Outdoor and Indoor IP44, 230 V AC.

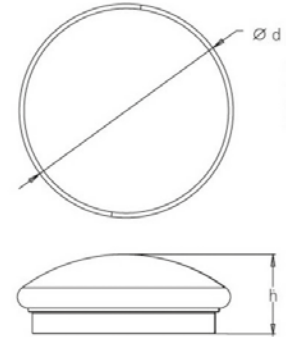

DATI TECNICI - TECHNICAL DATA



220-240 V AC



6-24 W

CRI

80



CL I



ALUMINIUM



0,3 - 0,6Kg

IP

44

VARIANTI - OPTIONS

Cod.	W	K	lumen	H	Ø	€
5410288432601	6 W	4000K	400 lumen	75 mm	180 mm	
5410288432618	12 W	4000K	810 lumen	85 mm	260 mm	
5410288432625	18 W	4000K	1300 lumen	95 mm	340 mm	
5410288432632	24W	4000K	1600 lumen	105 mm	380 mm	



INDOOR

OUTDOOR

STRIP

ROAD

INDUSTRIAL

TERRA 1000



Proiettore a LED da terra per esterni IP65 con diffusore in vetro satinato e struttura in alluminio pressofuso. Alimentazione 230V AC.

LED fixture for floor mounting Outdoor IP65, with glass diffuser and die-cast aluminum body. 230V AC.



DATI TECNICI - TECHNICAL DATA



220-240V
50/60Hz



20 W

CRI

80



CL I



DIE-CAST ALUMINIUM



5,5 Kg

IP

65

VARIANTI - OPTIONS

Cod.	Colore Colors	Temperatura colore Color temperature	Flusso Luminoso Luminous flux	Apertura Fascio Beam angle	€
E5775-LBN	Antracite Anthracite	4000K	1100 lumen	Simmetrico omnidirezionale	



TERRA 500



Proiettore a LED da terra per esterni IP65 con diffusore in vetro satinato e struttura in alluminio pressofuso. Alimentazione 230V AC.

LED fixture for floor mounting Outdoor IP65, with glass diffuser and die-cast aluminum body. 230V AC.

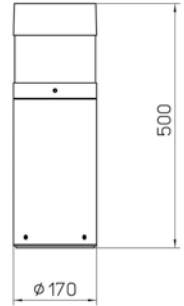

DATI TECNICI - TECHNICAL DATA



220-240V
50/60Hz



20 W

CRI

80



CL I



DIE-CAST ALUMINIUM



4 Kg

IP

65

VARIANTI - OPTIONS

Cod.	Colore Colors	Temperatura colore Color temperature	Flusso Luminoso Luminous flux	Apertura Fascio Beam angle	€
E5776-LBN	Antracite Anthracite	4000K	1100 lumen	Simmetrico omnidirezionale	



INDOOR

OUTDOOR

STRIP

ROAD

INDUSTRIAL



NOVITÀ - Questo sarebbe dovuto essere il nome della nuova linea di proiettori a LED chiamata FORTE progettata e realizzata per essere utilizzata ovunque sia necessario poter mettere a fuoco un'immagine o sagomare la luce con l'utilizzo di lamelle andando incontro ad un nuovo concetto di illuminazione da esterno.

NOVELTY - This should have been the name of the new line of LED projectors called FORTE designed and built to be used wherever it is necessary to be able to focus on an image or shape the light with the use of blades going towards a new concept of lighting from outside.



FORTE PROFILE

FORTE PROFILE 150 HD WL 10° - 15°/16° - 30°

IP 65



Sagomatore maneggevole dalle dimensioni compatte, per utilizzo in esterni ed interni con sorgente a LED COB ad altissima resa luminosa ed alta definizione, con ottica 10°/15° o 16°/30°. Regolazione manuale dello zoom e del focus. Controllato da segnale DMX via Wireless. Vernice resistente alla nebbia salina. Valvola anti condensa.

Handy profile with small dimensions for outdoor and indoor use, with 1 LED COB source, with very high light output, 10°/15° or 16°/30° optics and high definition beam, manual regulation of zoom and focus. Controlled by DMX via Wireless. Paint resistant to salt mist. Anti-condensation valve.

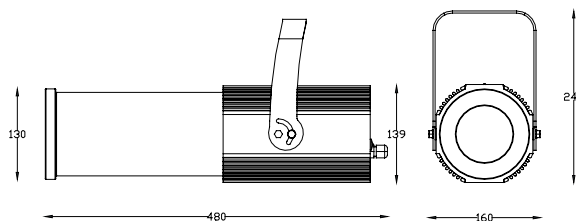

DATI TECNICI - TECHNICAL DATA



100-240 V AC
50/60Hz



58 W

CRI

80 - 92



CL I



ALUMINIUM



4,5 Kg

IP

65

VARIANTI - OPTIONS

Cod.	Color	Temperatura colore Color temperature	Ottica Optics	€
0913057090	Grey	3000K CRI 92	10° - 15°	
0913057004	Grey	5600K CRI 80	10° - 15°	
0913065204	Grey	3000K CRI 92	16° - 30°	
0913067004	Grey	5600K CRI 80	16° - 30°	

ACCESSORI - ACCESSORIES

Cod. 4400000005
FORTE CONTROL



10° - 15°

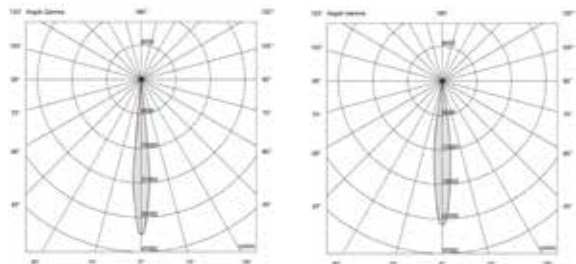

16° - 30°

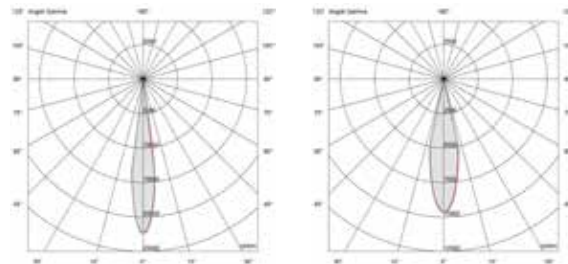

FORTE PROFILE 150 HD WL 20° - 40°

IP
65



Sagomatore maneggevole dalle dimensioni compatte, per utilizzo in esterni ed interni con sorgente a LED COB ad altissima resa luminosa ed alta definizione, con ottica 20°/40°. Regolazione manuale dello zoom e del focus. Controllato da segnale DMX via Wireless. Vernice resistente alla nebbia salina. Valvola anti condensa.

Handy profile with small dimensions for outdoor and indoor use, with 1 LED COB source, with very high light output, 20°/40° optics and high definition beam, manual regulation of zoom and focus. Controlled by DMX via Wireless. Paint resistant to salt mist. Anti-condensation valve.

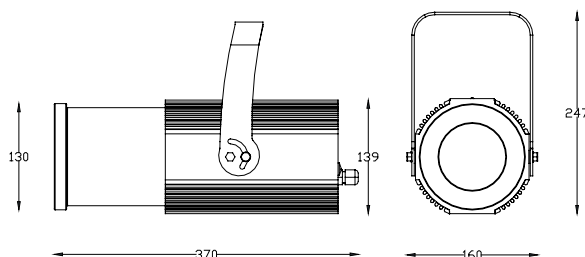

DATI TECNICI - TECHNICAL DATA



VARIANTI - OPTIONS

Cod.	Color	Temperatura colore Color temperature	Ottica Optics	€
0913085204	Grey	3000K CRI 92	20° - 40°	
0913087004	Grey	5600K CRI 80	20° - 40°	

20° - 40°

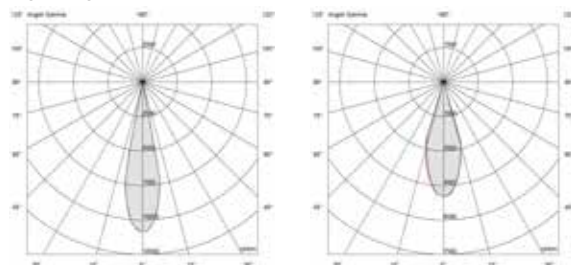

FORTE PROFILE 150 HD DALI 10° - 15°/16° - 30°

IP 65



Sagomatore maneggevole dalle dimensioni compatte, per utilizzo in esterni ed interni con sorgente a LED COB ad altissima resa luminosa ed alta definizione, con ottica 10°/15° o 16°/30°. Regolazione manuale dello zoom e del focus. Controllato da segnale DALI. Vernice resistente alla nebbia salina. Valvola anti condensa.

Handy profile with small dimensions for outdoor and indoor use, with 1 LED COB source, with very high light output, 10°/15° or 16°/30° optics and high definition beam, manual regulation of zoom and focus. Controlled by DALI signal. Paint resistant to salt mist. Anti-condensation valve.

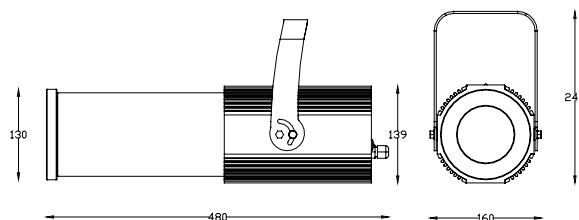

DATI TECNICI - TECHNICAL DATA



100-240 V AC
50/60Hz



58 W

CRI

80 - 92



CL I



ALUMINIUM



4,5 Kg

IP

65

VARIANTI - OPTIONS

Cod.	Color	Temperatura colore Color temperature	Ottica Optics	€
0913057190	Grey	3000K CRI 92	10° - 15°	
0913057104	Grey	5600K CRI 80	10° - 15°	
0913067190	Grey	3000K CRI 92	16° - 30°	
0913067104	Grey	5600K CRI 80	16° - 30°	

10° - 15°

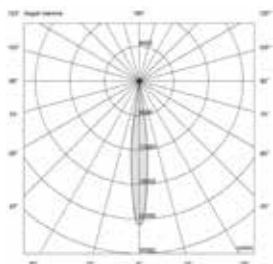
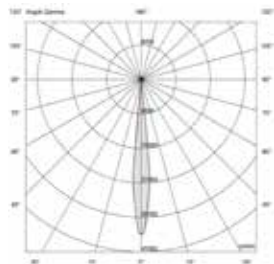

16° - 30°

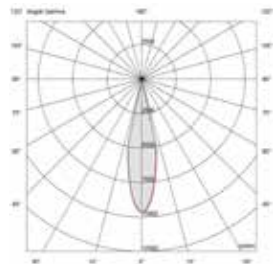
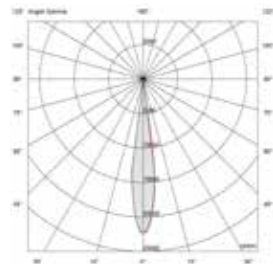

FORTE PROFILE 150 HD DALI 20° - 40°

IP 65



Sagomatore maneggevole dalle dimensioni compatte, per utilizzo in esterni ed interni con sorgente a LED COB ad altissima resa luminosa ed alta definizione, con ottica 20°/40°. Regolazione manuale dello zoom e del focus. Controllato da segnale DALI. Vernice resistente alla nebbia salina. Valvola anti condensa.

Handy profile with small dimensions for outdoor and indoor use, with 1 LED COB source, with very high light output, 20°/40° optics and high definition beam, manual regulation of zoom and focus. Controlled by DALI signal. Paint resistant to salt mist. Anti-condensation valve.

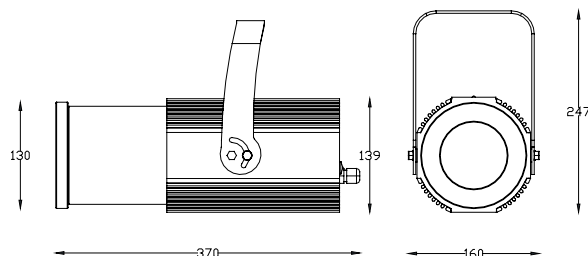

DATI TECNICI - TECHNICAL DATA



CRI
80 - 92

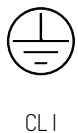

IP
65

VARIANTI - OPTIONS

Cod.	Color	Temperatura colore Color temperature	Ottica Optics	€
0913087190	Grey	3000K CRI 92	20° - 40°	
0913087104	Grey	5600K CRI 80	20° - 40°	



20° - 40°

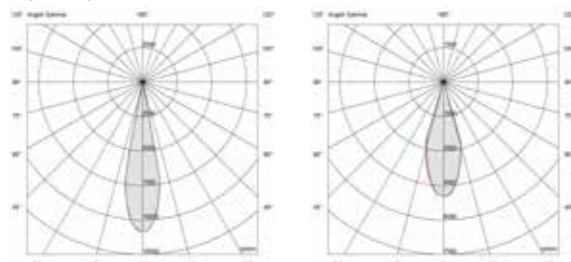

FORTE PROFILE 150 HD DMX 10° - 15°/16° - 30°

IP
65



Sagomatore maneggevole dalle dimensioni compatte, per utilizzo in esterni ed interni con sorgente a LED COB ad altissima resa luminosa ed alta definizione, con ottica 10°/15° o 16°/30°. Regolazione manuale dello zoom e del focus. Controllato da segnale DMX. Vernice resistente alla nebbia salina. Valvola anti condensa.

Handy profile with small dimensions for outdoor and indoor use, with 1 LED COB source, with very high light output, 10°/15° or 16°/30° optics and high definition beam, manual regulation of zoom and focus. Controlled by DMX. Paint resistant to salt mist. Anti-condensation valve.

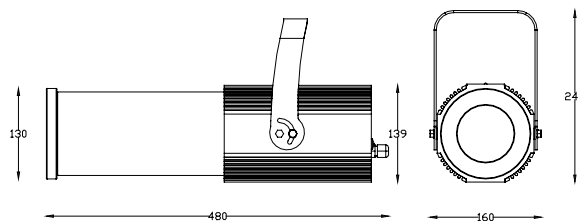

DATI TECNICI - TECHNICAL DATA



100-240 V AC
50/60Hz



58 W

CRI

80 - 92



CL I



ALUMINIUM



4,5 Kg

IP

65

VARIANTI - OPTIONS

Cod.	Color	Temperatura colore Color temperature	Ottica Optics	€
0913056690	Grey	3000K CRI 92	10° - 15°	
0913056604	Grey	5600K CRI 80	10° - 15°	
0913066690	Grey	3000K CRI 92	16° - 30°	
0913066604	Grey	5600K CRI 80	16° - 30°	

ACCESSORI - ACCESSORIES

Cod. 4400000005
FORTE CONTROL



10° - 15°

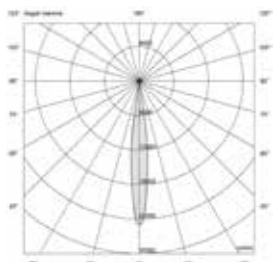
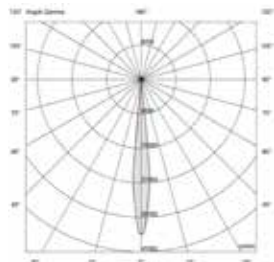

16° - 30°

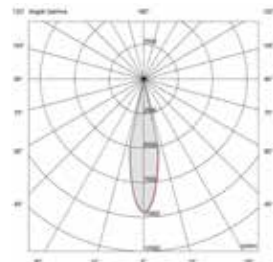
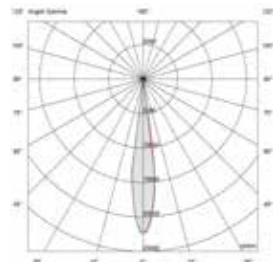

FORTE PROFILE 150 HD DMX 20° - 40°

IP
65



Sagomatore maneggevole dalle dimensioni compatte, per utilizzo in esterni ed interni con sorgente a LED COB ad altissima resa luminosa ed alta definizione, con ottica 20°/40°. Regolazione manuale dello zoom e del focus. Controllato da segnale DMX. Vernice resistente alla nebbia salina. Valvola anti condensa.

Handy profile with small dimensions for outdoor and indoor use, with 1 LED COB source, with very high light output, 20°/40° optics and high definition beam, manual regulation of zoom and focus. Controlled by DMX. Paint resistant to salt mist. Anti-condensation valve.

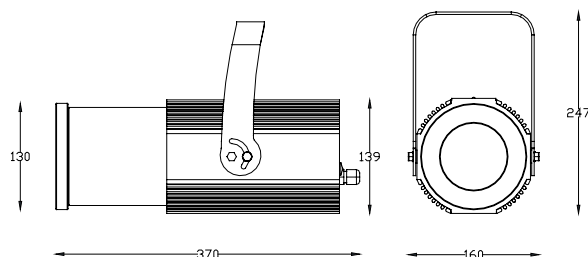

DATI TECNICI - TECHNICAL DATA



VARIANTI - OPTIONS

Cod.	Color	Temperatura colore Color temperature	Ottica Optics	€
0913086690	Grey	3000K CRI 92	20° - 40°	
0913086604	Grey	5600K CRI 80	20° - 40°	

20° - 40°

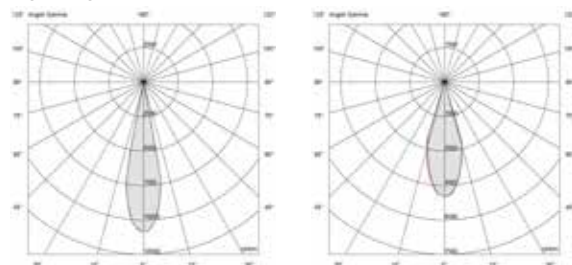

FORTE PROFILE 150 HD 10° - 15°/16° - 30°

IP
65



Sagomatore maneggevole dalle dimensioni compatte, per utilizzo in esterni ed interni con sorgente a LED COB ad altissima resa luminosa ed alta definizione del fascio luminoso, completo di porta gobo. Regolazione manuale dello zoom e del focus. Vernice resistente alla nebbia salina. Valvola anti condensa.

Handy profile with small dimensions for outdoor and indoor use, with 1 LED COB source, with very high light output and high definition light beam, manual regulation of zoom and focus, and micro blades for profile light. Gobo holder included. Paint resistant to salt mist. Anti-condensation valve.

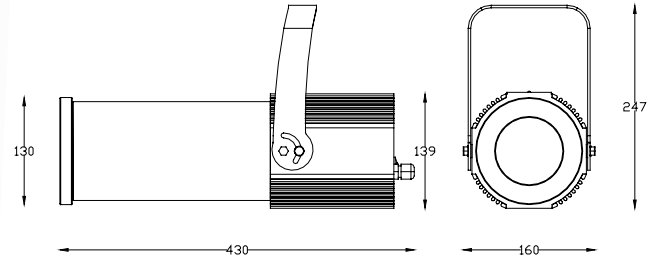

DATI TECNICI - TECHNICAL DATA



100-240 V AC
50/60Hz



58 W

CRI

80 - 92



CL I



ALUMINIUM



4,5 Kg

IP

65

VARIANTI - OPTIONS

Cod.	Color	Temperatura colore Color temperature	Ottica Optics	€
0912402990	Grey	3000K CRI 92	10° - 15°	
0912402904	Grey	5600K CRI 80	10° - 15°	
0912412990	Grey	3000K CRI 92	16° - 30°	
0912412904	Grey	5600K CRI 80	16° - 30°	

10° - 15°

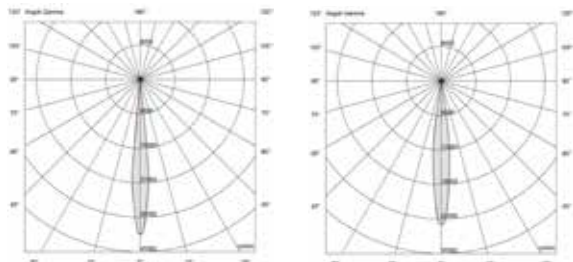

16° - 30°

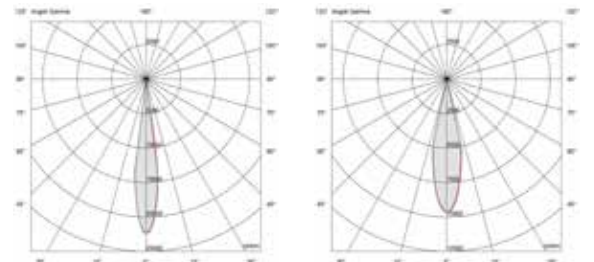

FORTE PROFILE 150 HD 20° - 40°

IP
65



Sagomatore maneggevole dalle dimensioni compatte, per utilizzo in esterni ed interni con sorgente a LED COB ad altissima resa luminosa ed alta definizione del fascio luminoso, completo di porta gobo. Regolazione manuale dello zoom e del focus. Vernice resistente alla nebbia salina. Valvola anti condensa.

Handy profile with small dimensions for outdoor and indoor use, with 1 LED COB source, with very high light output and high definition light beam, manual regulation of zoom and focus, and micro blades for profile light. Gobo holder included. Paint resistant to salt mist. Anti-condensation valve.

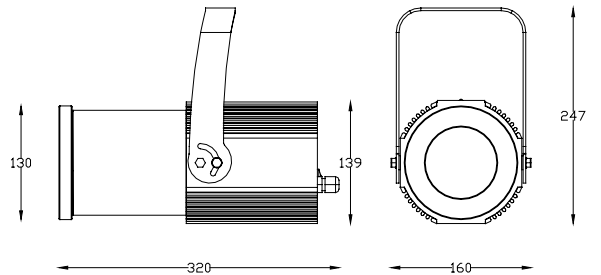

DATI TECNICI - TECHNICAL DATA



100-240 V AC
50/60Hz



58 W

CRI

80 - 92



CL I



ALUMINIUM



4,5 Kg

IP

65

VARIANTI - OPTIONS

Cod.	Color	Temperatura colore Color temperature	Ottica Optics	€
0912062990	Grey	3000K CRI 92	20° - 40°	
0912062904	Grey	5600K CRI 80	20° - 40°	

20° - 40°

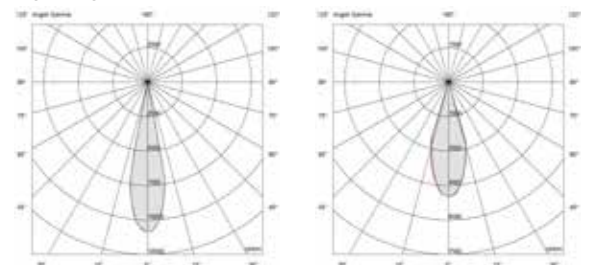

FORTE PROFILE 150 10° - 15° / 16° - 30°

IP
65



Sagomatore maneggevole dalle dimensioni compatte, per utilizzo in esterni ed interni con sorgente a LED COB ad altissima resa luminosa, completo di porta gobo. Regolazione manuale dello zoom e del focus. Vernice resistente alla nebbia salina. Valvola anti condensa.

Handy profile with small dimensions for outdoor and indoor use, with 1 LED COB source, with very high light output, manual regulation of zoom and focus, and micro blades for profile light. Gobo holder included. Paint resistant to salt mist. Anti-condensation valve.

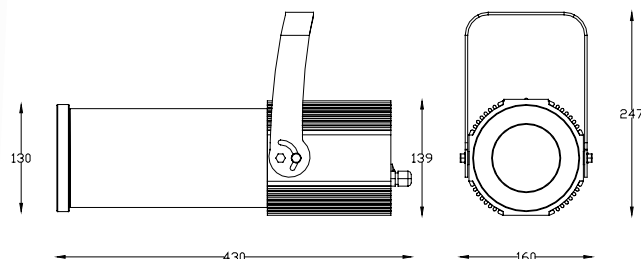

DATI TECNICI - TECHNICAL DATA



100-240 V AC
50/60Hz



58 W

CRI

80 - 92



CL I



ALUMINIUM



4,5 Kg

IP

65

VARIANTI - OPTIONS

Cod.	Color	Temperatura colore Color temperature	Ottica Optics	€
0912405204	Grey	3000K CRI 92	10° - 15°	
0912406504	Grey	5600K CRI 80	10° - 15°	
0912415204	Grey	3000K CRI 92	16° - 30°	
0912416504	Grey	5600K CRI 80	16° - 30°	

10° - 15°

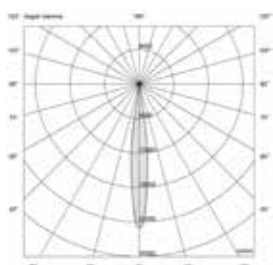
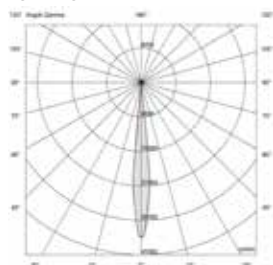

16° - 30°

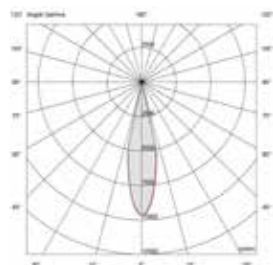
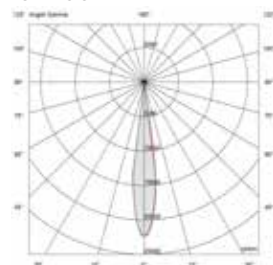

FORTE PROFILE 150 20° - 40°

IP
65



Sagomatore maneggevole dalle dimensioni compatte, per utilizzo in esterni ed interni con sorgente a LED COB ad altissima resa luminosa, completo di porta gobo. Regolazione manuale dello zoom e del focus. Vernice resistente alla nebbia salina. Valvola anti condensa.

Handy profile with small dimensions for outdoor and indoor use, with 1 LED COB source, with very high light output, manual regulation of zoom and focus, and micro blades for profile light. Gobo holder included. Paint resistant to salt mist. Anti-condensation valve.

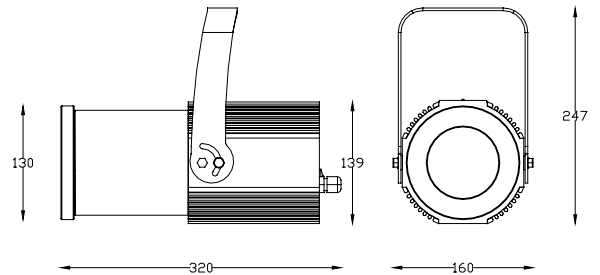

DATI TECNICI - TECHNICAL DATA



100-240 V AC
50/60Hz



58 W

CRI

80 - 92



CL I



ALUMINIUM



4,5 Kg

IP

65

VARIANTI - OPTIONS

Cod.	Color	Temperatura colore Color temperature	Ottica Optics	€
0912065204	Grey	3000K CRI 92	20° - 40°	
0912064104	Grey	5600K CRI 80	20° - 40°	

20° - 40°

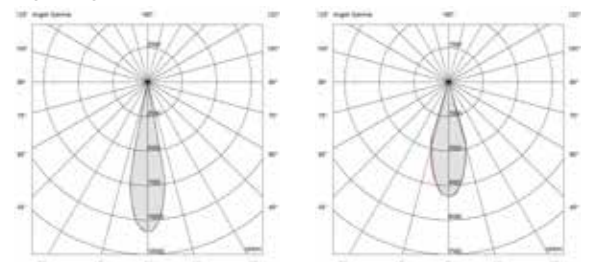

FORTE 150 WL F/PC

IP
65



Spot maneggevole dalle dimensioni compatte, per utilizzo in esterni ed interni con sorgente a LED COB ad altissima resa luminosa. Regolazione manuale dell'apertura del fascio luminoso. Controllato da segnale DMX via Wireless. Vernice resistente alla nebbia salina. Valvola anti condensa.

Handy profile with small dimensions for outdoor and indoor use, with 1 LED COB source, with very high light output, manual regulation of beam angle. Controlled by DMX via Wireless. Paint resistant to salt mist. Anti-condensation valve.

DATI TECNICI - TECHNICAL DATA



VARIANTI - OPTIONS

Cod.	Color	Temperatura colore Color temperature	Ottica Optics	€
0912037090	Grey	3000K CRI 92	Fresnel 14° - 45°	
0912017090	Grey	3000K CRI 92	PC 17° - 47°	
0912037093	Grey	5600K CRI 80	Fresnel 14° - 45°	
0912017093	Grey	5600K CRI 80	PC 17° - 47°	

ACCESSORI - ACCESSORIES

Cod. 4400000005
FORTE CONTROL



FRESNEL 4,3 kg

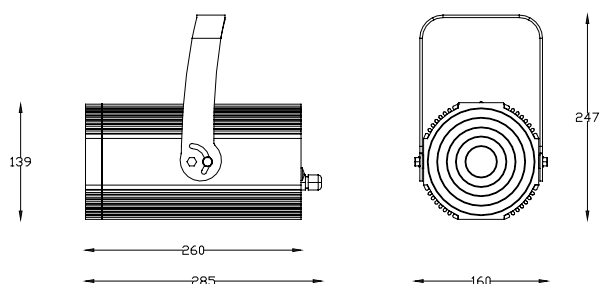

PC 5 kg

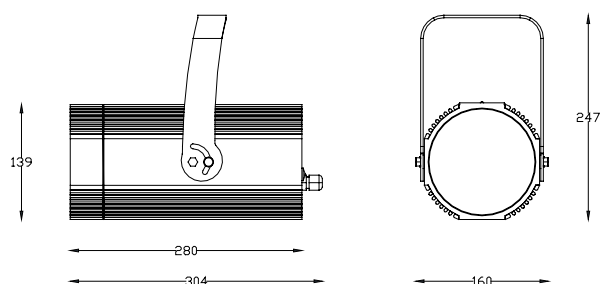

FORTE 150 DMX F/PC





IP
65



Spot maneggevole dalle dimensioni compatte, per utilizzo in esterni ed interni con sorgente a LED COB ad altissima resa luminosa. Regolazione manuale dell'apertura del fascio luminoso. Controllato da segnale DMX. Vernice resistente alla nebbia salina. Valvola anti condensa.

Handy profile with small dimensions for outdoor and indoor use, with 1 LED COB source, with very high light output, manual regulation of beam angle. Controlled by DMX. Paint resistant to salt mist. Anti-condensation valve.

DATI TECNICI - TECHNICAL DATA

		CRI				IP
100-240 V AC 50/60Hz	58 W	80 - 92	CL I	ALUMINIUM	4,3 - 5 Kg	65

VARIANTI - OPTIONS

Cod.	Color	Temperatura colore Color temperature	Ottica Optics	€
0912036690	Grey	3000K CRI 92	Fresnel 14° - 45°	
0912016690	Grey	3000K CRI 92	PC 17° - 47°	
0912036693	Grey	5600K CRI 80	Fresnel 14° - 45°	
0912016693	Grey	5600K CRI 80	PC 17° - 47°	

ACCESSORI - ACCESSORIES

Cod. 4400000005
FORTE CONTROL



FRESNEL 4,3 kg

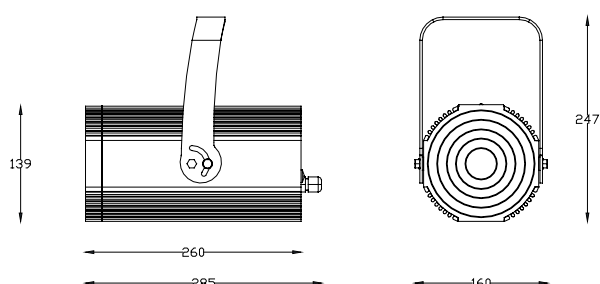

PC 5 kg

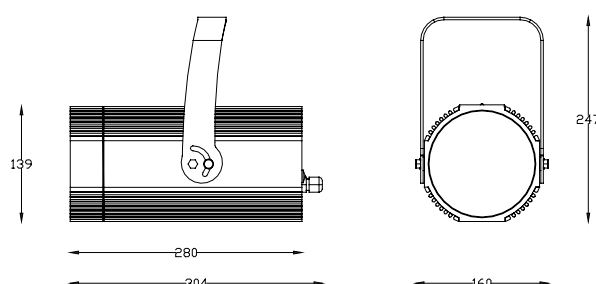

FORTE 150 F/PC

IP
65



Spot maneggevole dalle dimensioni compatte, per utilizzo in esterni ed interni con sorgente a LED COB ad altissima resa luminosa. Regolazione manuale dell'apertura del fascio luminoso. Vernice resistente alla nebbia salina. Valvola anti condensa.

Handy profile with small dimensions for outdoor and indoor use, with 1 LED COB source, with very high light output, manual regulation of beam angle. Paint resistant to salt mist. Anti-condensation valve.

DATI TECNICI - TECHNICAL DATA



VARIANTI - OPTIONS

Cod.	Color	Temperatura colore Color temperature	Ottica Optics	€
0912030090	Grey	3000K CRI 92	Fresnel 14° - 45°	
0912010090	Grey	3000K CRI 92	PC 17° - 47°	
0912030093	Grey	5600K CRI 80	Fresnel 14° - 45°	
0912010093	Grey	5600K CRI 80	PC 17° - 47°	

FRESNEL 4,3 kg

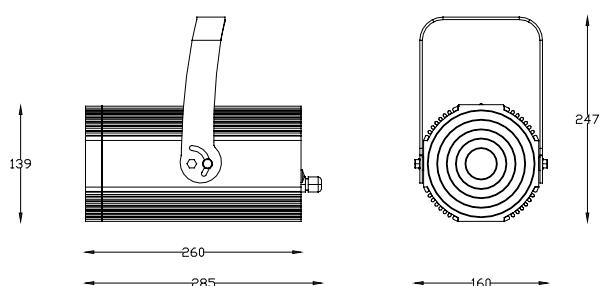

PC 5 kg

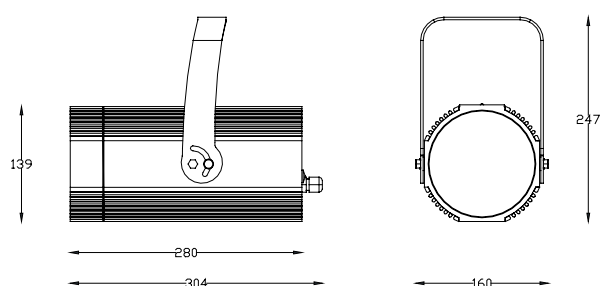





La modalità di applicazione per mezzo del nastro biadesivo e la flessibilità del circuito stampato fanno sì che possano aderire a qualsiasi superficie. E' questo il punto di forza delle strip led che trovano applicazione nell'illuminazione generale, nella retro illuminazione, all'interno di un arredo o come semplice illuminazione d'accento per caratterizzare un particolare oggetto. Infiniti ambiti che hanno la fantasia come unico limite.

Due to the double - sided tape and the flexibility of the printed circuit it can adhere at whatever surface. This is the strong point of the strip led which is used for general lighting, backlight, in a furniture or as a simple accent lighting to highlight a special point. Strip leds are offering an endless range of applications limited only by the own imagination.



STRIP

STRIP LED RGB FC 24V 60W 60 L/M IP65

Striscia a LED flessibile, isolate con tubo in silicone, da 60 LED full color RGB per metro, in rotoli da 5 mt, 24 V DC, 60 W.

Flexible strip LED, seal with silicon, 60 LED full color RGB per meter, in 5 mt rolls, 24 VDC, 60 W.

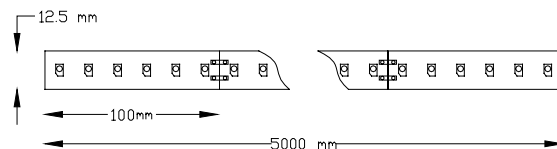

DATI TECNICI - TECHNICAL DATA



24 V DC



60 W



CL III



FLEXIBLE PCB + SILICON

IP

65



RGB

VARIANTI - OPTIONS

Cod.	Temperatura colore Color temperature	Flusso Luminoso Luminous flux	Apertura Fascio Beam angle	€
LS1812RGB	RGB	2400 lumen	120°	

ACCESSORI - ACCESSORIES

Cod. 0209218844 alimentatore a tensione costante 24 V DC 30W IP67



Cod. 0213210044 alimentatore a tensione costante 24 V DC 60W IP67



Cod. 0216210044 alimentatore a tensione costante 24 V DC 100W IP67



Cod. 0219210044 alimentatore a tensione costante 24 V DC 150W IP67



Cod. 0202210001 alimentatore a tensione costante 24 V DC 200W IP20



Cod. 2113000044 Controller DMX



Cod. 60000344 4 ch amplifier



Cod. 29090106 - Sunlite Stick Gu2



Cod. 1000000121 RF touch control rgb



Cod. 1000000121 Ricevitore touch control rgb



STRIP LED WHITE POWER 24V 58W 70 L/M IP65



Striscia a LED flessibile, isolate con tubo in silicone, da 70 LED per metro, in rotoli da 5 mt, 24 V DC, 58 W.

Flexible strip LED, seal with silicon, 70 LED per meter, in 5 mt rolls, 24 V DC, 58 W.

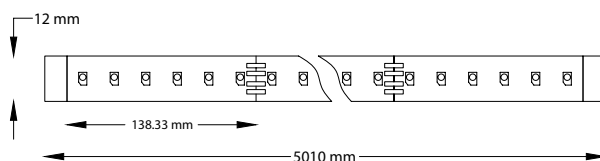

DATI TECNICI - TECHNICAL DATA



24 V DC



58 W

CRI

80



CL III



FLEXIBLE PCB + SILICON

IP

65

VARIANTI - OPTIONS

Cod.	Temperatura colore Color temperature	Flusso Luminoso Luminous flux	Apertura Fascio Beam angle	€
4052899526419	4000K	7600 lumen	120°	
4052899526396	3000K	7225 lumen	120°	

ACCESSORI - ACCESSORIES

Cod. 0209218844 alimentatore a tensione costante 24 V DC 30W IP67	Cod. 0213210044 alimentatore a tensione costante 24 V DC 60W IP67
-------------------------------------------------------------------------	-------------------------------------------------------------------------



Cod. 0216210044 alimentatore a tensione costante 24 V DC 100W IP67	Cod. 0219210044 alimentatore a tensione costante 24 V DC 150W IP67
--------------------------------------------------------------------------	--------------------------------------------------------------------------



Cod. 0202210001 alimentatore a tensione costante 24 V DC 200W IP20	Cod. 33030044 - dimmer push 1ch
--------------------------------------------------------------------------	------------------------------------



Cod. 60000144 1 ch amplifier	Cod. 2800000044 pulsante Wi-Fi
---------------------------------	-----------------------------------



INDOOR

OUTDOOR

STRIP

ROAD

INDUSTRIAL

STRIP LED WHITE 24V 60W 60 L/M IP20

Striscia a LED flessibile, da 60 LED per metro, in rotoli da 5 mt, 24 V DC, 60 W.

Flexible strip LED, 60 LED per meter, in 5 mt rolls, 24 V DC, 60 W.

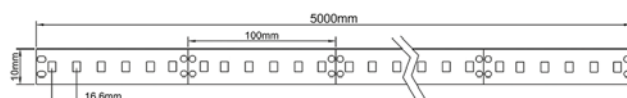

DATI TECNICI - TECHNICAL DATA



24 V DC



60 W

CRI

80



CL III



FLEXIBLE PCB

IP

20

VARIANTI - OPTIONS

Cod.	Temperatura colore Color temperature	Flusso Luminoso Luminous flux	Apertura Fascio Beam angle	€
5213920085	4000K	7200 lumen	120°	
5213920081	3000K	6900 lumen	120°	

ACCESSORI - ACCESSORIES

Cod. 0209218844 alimentatore a tensione costante 24 V DC 30W IP67



Cod. 0213210044 alimentatore a tensione costante 24 V DC 60W IP67



Cod. 0216210044 alimentatore a tensione costante 24 V DC 100W IP67



Cod. 0219210044 alimentatore a tensione costante 24 V DC 150W IP67



Cod. 0202210001 alimentatore a tensione costante 24 V DC 200W IP20



Cod. 33030044 - dimmer push 1ch



Cod. 60000144 1 ch amplifier



Cod. 2800000044 pulsante Wi-Fi



STRIP LED WHITE POWER 24V 115W 120 L/M IP20

Striscia a LED flessibile, da 120 LED per metro, in rotoli da 5 mt., 24 V DC, 115 W.

Flexible strip LED, 120 LED per meter, in 5 mt rolls, 24 V DC, 115 W.

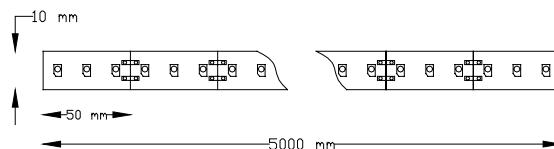

DATI TECNICI - TECHNICAL DATA



24 V DC



115 W

CRI

80



CL III



FLEXIBLE PCB

IP

20

VARIANTI - OPTIONS

Cod.	Temperatura colore Color temperature	Flusso Luminoso Luminous flux	Apertura Fascio Beam angle	€
5216000100	4000K	14000 lumen	120°	
5216000181	3000K	13800 lumen	120°	

ACCESSORI - ACCESSORIES

Cod. 0209218844 alimentatore a tensione costante 24 V DC 30W IP67	Cod. 0213210044 alimentatore a tensione costante 24 V DC 60W IP67
Cod. 0216210044 alimentatore a tensione costante 24 V DC 100W IP67	Cod. 0219210044 alimentatore a tensione costante 24 V DC 150W IP67
Cod. 0202210001 alimentatore a tensione costante 24 V DC 200W IP20	Cod. 33030044 - dimmer push 1ch
Cod. 60000144 1 ch amplifier	Cod. 2800000044 pulsante Wi-Fi



INDOOR

OUTDOOR

STRIP

ROAD

INDUSTRIAL

PROFILO WIDE

INDOOR

OUTDOOR

STRIP



Profilo in alluminio di alta qualità anodizzato, completo di copertura, 2 tappi di chiusura e 2 clip di fissaggio. Lunghezza 2 mt

High-quality aluminium profile, anodized. Complete with cover, 2 end cups and 2 mounting brackets. 2 mt length.

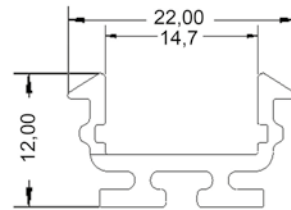

VARIANTI - OPTIONS

Cod.	Copertura Cover	Lunghezza Lenght	€
21100000 02	Trasparente Clear	2 mt	
21100066 02	Satinata Frosted	2 mt	

ACCESSORI - ACCESSORIES

Cod. 16100000 06 Tappo	Cod. 17100000 06 Clip fissaggio

RETROFIT

PROFILO

PISCINA

FONTANA

STRADALE

INDUSTRIALE

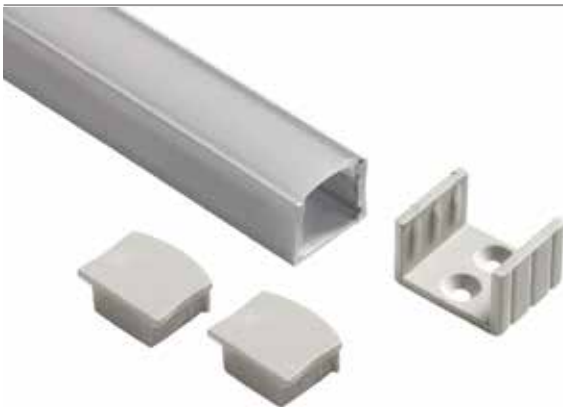

Profilo in alluminio di alta qualità anodizzato, completo di copertura, 2 tappi di chiusura e 2 clip di fissaggio. Lunghezza 2 mt

High-quality aluminium profile, anodized. Complete with cover, 2 end cups and 2 mounting brackets. 2 mt length.

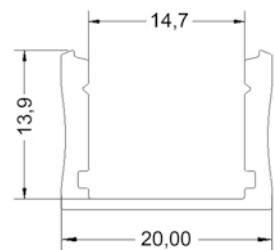

VARIANTI - OPTIONS

Cod.	Copertura Cover	Lunghezza Lenght	€
21000000 02	Trasparente Clear	2 mt	
21010000 02	Satinata Frosted	2 mt	

ACCESSORI - ACCESSORIES

Cod. 16090000 06 Tappo	Cod. 17100004 06 Clip fissaggio

PROFILO ROTONDO



Profilo in alluminio di alta qualità anodizzato, completo di copertura, 2 tappi di chiusura e 2 clip di fissaggio. Lunghezza 2 mt

High-quality aluminium profile, anodized. Complete with cover, 2 end cups and 2 mounting brackets. 2 mt length.

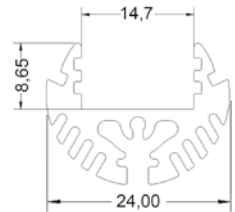

VARIANTI - OPTIONS

Cod.	Copertura Cover	Lunghezza Length	€
21260000 02	Trasparente Clear	2 mt	
0000010466	Satinata Frosted	2 mt	

ACCESSORI - ACCESSORIES

Cod. 16020000 06 Tappo	Cod. 17020000 06 Clip fissaggio

PROFILO INCASSO WALL



Profilo in alluminio di alta qualità anodizzato, completo di copertura, 2 tappi di chiusura. Lunghezza 2 mt

High-quality aluminium profile, anodized. Complete with cover, 2 end cups. 2 mt length.

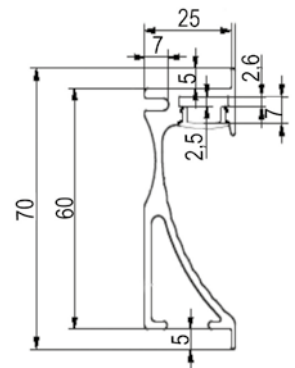

VARIANTI - OPTIONS

Cod.	Copertura Cover	Lunghezza Length	€
21170000 02	Trasparente Clear	2 mt	
21170066 02	Satinata Frosted	2 mt	

ACCESSORI - ACCESSORIES

Cod. 16170000 06 Tappo sinistro	Cod. 17170000 06 Tappo destro

INDOOR

OUTDOOR

STRIP

ROAD

INDUSTRIAL

PROFILO SLIM

INDOOR

OUTDOOR



Profilo in alluminio di alta qualità anodizzato, completo di copertura, 2 tappi di chiusura e 2 clip di fissaggio. Lunghezza 2 mt

High-quality aluminium profile, anodized. Complete with cover, 2 end cups and 2 mounting brackets. 2 mt length.

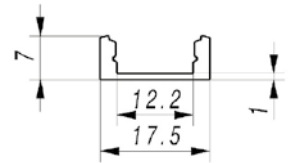

VARIANTI - OPTIONS

Cod.	Copertura Cover	Lunghezza Lenght	€
21040000 02	Trasparente Clear	2 mt	
21040066 02	Satinata Frosted	2 mt	

ACCESSORI - ACCESSORIES

Cod. 16040000 06 Tappo	Cod. 17040000 06 Clip fissaggio

STRIP

PROFILO DA INCASSO

STRADALE



Profilo in alluminio di alta qualità anodizzato, completo di copertura, 2 tappi di chiusura. Lunghezza 2 mt

High-quality aluminium profile, anodized. Complete with cover, 2 end cups. 2 mt length.

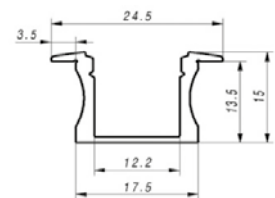

VARIANTI - OPTIONS

Cod.	Copertura Cover	Lunghezza Lenght	€
21220065 02	Trasparente Clear	2 mt	
21220066 02	Satinata Frosted	2 mt	

ACCESSORI - ACCESSORIES

Cod. 16220000 06 Tappo	

INDUSTRIALE

PROFILO TRIANGOLARE



Profilo in alluminio di alta qualità anodizzato, completo di copertura, 2 tappi di chiusura e 2 clip di fissaggio. Lunghezza 2 mt

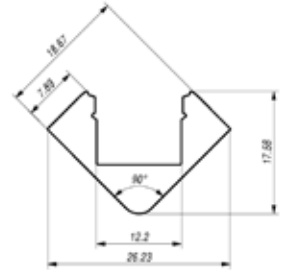

High-quality aluminium profile, anodized. Complete with cover, 2 end cups and 2 mounting brackets. 2 mt length.



VARIANTI - OPTIONS

Cod.	Copertura Cover	Lunghezza Lenght	€
21340000 02	Trasparente Clear	2 mt	
21340066 02	Satinata Frosted	2 mt	

ACCESSORI - ACCESSORIES

Cod. 17340000 06 Tappo	Cod. 116340000 06 Clip fissaggio
	

INDOOR

OUTDOOR

STRIP

ROAD

INDUSTRIAL



Nelle città e lungo le strade una buona illuminazione è essenziale per la sicurezza, in quanto garantisce la visibilità nelle ore di buio per automobilisti, ciclisti e pedoni. La gamma di prodotti a led per ambito stradale introduce un grosso risparmio energetico e allo stesso tempo rende più attraenti le città e le comunità, mettendo in risalto i punti di attrazione locali e conferendo una maggior atmosfera al contesto urbano.

A good lighting along the streets is essential for safety as it is granting visibility to drivers, cyclists and pedestrians in the dark. The range of LED products for street lighting is offering huge energy savings and at the same time will it make cities and communities more attractive highlighting local sights.





STRADALE

SUNLED AS

Apparecchio a led con ottica secondaria adatto all'illuminazione stradale e l'arredo urbano. Uscita luce circolare. Regolazione della luminosità programmabile da software.

LED fixture with secondary optic for street and urban lighting. Circular light beam. Light intensity controllable via software.

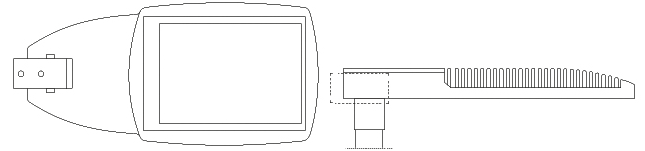

DATI TECNICI - TECHNICAL DATA

		CRI				IP		cos φ
220-240 V AC 50-60 Hz	DIM	70	CL II	DIE-CAST ALUMINIUM	10-12 Kg	66	0,25 m ²	0,98

VARIANTI - OPTIONS

Cod.	W	Temperatura colore Color temperature	nr LED	Flusso Luminoso Luminous flux	€
0005808426DIM	34	4000 K	8	3950 lumen	
	48			5350 lumen	
	68			6750 lumen	
0005812426DIM	50	4000 K	12	5900 lumen	
	70			7900 lumen	
	100			10050 lumen	
0005816426DIM	67	4000 K	16	7850 lumen	
	96			10650 lumen	
	135			13450 lumen	
0005824426DIM	101	4000 K	24	11850 lumen	
	144			15850 lumen	
	203			20150 lumen	
0005832426DIM	134	4000 K	32	15850 lumen	
	192			20150 lumen	
	270			26850 lumen	

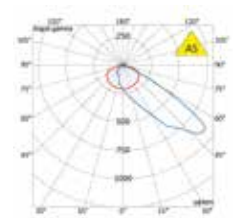

SMART AS

Apparecchio a led con ottica secondaria adatto all'illuminazione di grandi aree e parcheggi. Uscita luce asimmetrica. Regolazione della luminosità programmabile da software.

LED fixture with secondary optic for street, large area and car park lighting. Asymmetric light beam. Light intensity controllable via software.

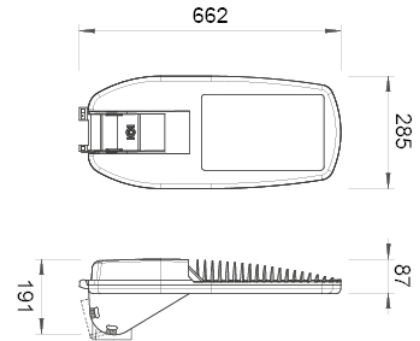

DATI TECNICI - TECHNICAL DATA

	CRI				IP	
220-240 V AC 50-60 Hz	75	CL II	DIE-CAST ALUMINIUM	8 - 8,70 Kg	66	0,19 m ²

VARIANTI - OPTIONS

Cod.	W	Temperatura colore Color temperature	nr LED	DIM	Flusso Luminoso Luminous flux	€
0006412246	27	4000 K	12	-	3050 lumen	
0006412246DIM	13	4000 K	12	√	1650 lumen	
	19				2300 lumen	
0006424246	27	4000 K	24	-	3050 lumen	
	53				6100 lumen	
0006424246DIM	27	4000 K	24	√	3300 lumen	
	37				4300 lumen	
0006436246DIM	53	4000 K	36	√	6100 lumen	
	80				9100 lumen	
0006448246	40	4000 K	48	-	4950 lumen	
	56				6900 lumen	
0006448246DIM	80	4000 K	48	√	9100 lumen	
	106				12150 lumen	
0006448246DIM	53	4000 K	48	-	6600 lumen	
	75				9150 lumen	
	106				12150 lumen	

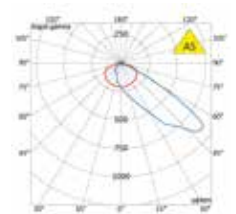
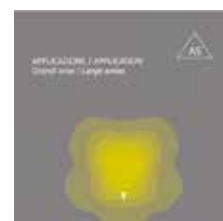

INDOOR

OUTDOOR

STRIP

ROAD

INDUSTRIAL

SMART FW

Apparecchio a led con ottica secondaria adatto all'illuminazione di grandi aree e parcheggi. Uscita luce asimmetrica. Regolazione della luminosità programmabile da software.

LED fixture with secondary optic for street, large area and car park lighting. Asymmetric light beam. Light intensity controllable via software.

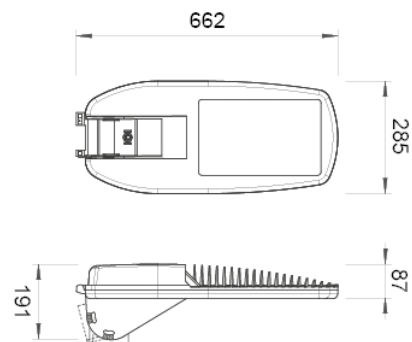

DATI TECNICI - TECHNICAL DATA

	CRI				IP	
220-240 V AC 50-60 Hz	75	CL II	DIE-CAST ALUMINIUM	8 - 8,70 Kg	66	0,19 m ²

VARIANTI - OPTIONS

Cod.	W	Temperatura colore Color temperature	nr LED	DIM	Flusso Luminoso Luminous flux	€
0006412247	27	4000 K	12	-	2850 lumen	
0006412247DIM	13	4000 K	12	√	1550 lumen	
	19				2150 lumen	
	27				2850 lumen	
0006424247	53	4000 K	24	-	5650 lumen	
	27				3100 lumen	
	37				4250 lumen	
0006424247DIM	53	4000 K	24	√	5650 lumen	
	80				8500 lumen	
	40				4600 lumen	
0006436247	80	4000 K	36	-	8500 lumen	
	56				6400 lumen	
	80				8500 lumen	
0006436247DIM	56	4000 K	36	√	6400 lumen	
	80				8500 lumen	
	106				11300 lumen	
0006448247	106	4000 K	48	-	11300 lumen	
	53				6150 lumen	
	75				8550 lumen	
0006448247DIM	75	4000 K	48	√	8550 lumen	
	106				11300 lumen	

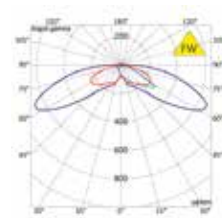
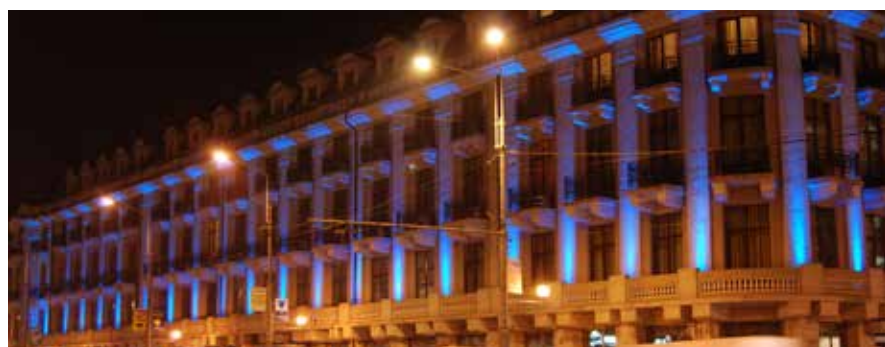

SMART S1

Apparecchio a led con ottica secondaria adatto all'illuminazione stradale a 2 corsie illuminate da un solo lato. Regolazione della luminosità programmabile da software.

LED fixture with secondary optic for two lane street lighting from one side. Light intensity controllable via software.

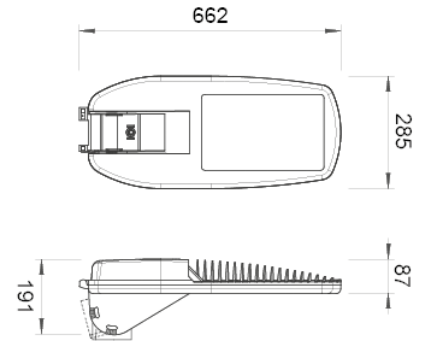

DATI TECNICI - TECHNICAL DATA

	CRI				IP	
220-240 V AC 50-60 Hz	75	CL II	DIE-CAST ALUMINIUM	8-8,70 Kg	66	0,19 m ²

VARIANTI - OPTIONS

Cod.	W	Temperatura colore Color temperature	nr LED	DIM	Flusso Luminoso Luminous flux	€
0006412245	27	4000 K	12	-	3050 lumen	
0006412245DIM	13	4000 K	12	√	1650 lumen	
	19				2300 lumen	
	27				3050 lumen	
0006424245	53	4000 K	24	-	6100 lumen	
	27				3300 lumen	
	37				4300 lumen	
0006424245DIM	53	4000 K	24	√	6100 lumen	
	80				9100 lumen	
	40				4950 lumen	
0006436245	80	4000 K	36	-	9100 lumen	
	56				6900 lumen	
	80				9100 lumen	
0006436245DIM	56	4000 K	36	√	6900 lumen	
	80				9100 lumen	
	106				12150 lumen	
0006448245	106	4000 K	48	-	12150 lumen	
	53				6600 lumen	
	75				9150 lumen	
0006448245DIM	75	4000 K	48	√	9150 lumen	
	106				12150 lumen	

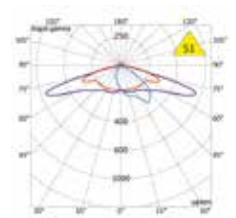
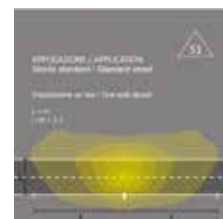

SMART S2

Apparecchio a led con ottica secondaria adatto all'illuminazione stradale a 1 corsia illuminate da un solo lato. Regolazione della luminosità programmabile da software.

LED fixture with secondary optic for one lane street lighting from one side. Light intensity controllable via software.

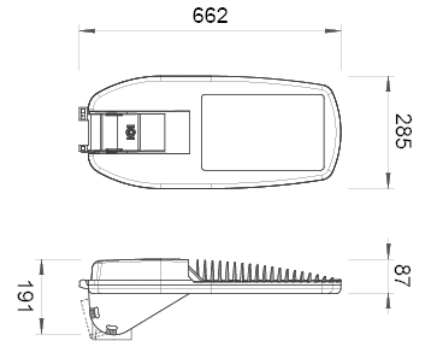

DATI TECNICI - TECHNICAL DATA

	CRI				IP	
220-240 V AC 50-60 Hz	75	CL II	DIE-CAST ALUMINIUM	8 - 8,70 Kg	66	0,19 m ²

VARIANTI - OPTIONS

Cod.	W	Temperatura colore Color temperature	nr LED	DIM	Flusso Luminoso Luminous flux	€
0006412242	27	4000 K	12	-	3050 lumen	
0006412242DIM	13	4000 K	12	√	1650 lumen	
	19				2300 lumen	
	27				3050 lumen	
0006424242	53	4000 K	24	-	6100 lumen	
	27				3300 lumen	
	37				4300 lumen	
0006424242DIM	53	4000 K	24	√	6100 lumen	
	80				9100 lumen	
	40				4950 lumen	
0006436242	80	4000 K	36	-	9100 lumen	
	56				6900 lumen	
	80				9100 lumen	
0006436242DIM	56	4000 K	36	√	6900 lumen	
	80				9100 lumen	
	106				12150 lumen	
0006448242	106	4000 K	48	-	12150 lumen	
	53				6600 lumen	
	75				9150 lumen	
0006448242DIM	75	4000 K	48	√	9150 lumen	
	106				12150 lumen	

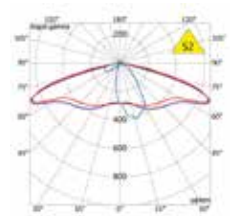

SMART S3

Apparecchio a led con ottica secondaria adatto all'illuminazione stradale a 2 corsie illuminate da entrambe i lati. Regolazione della luminosità programmabile da software..

LED fixture with secondary optic for two lane street lighting from two sides. Light intensity controllable via software.

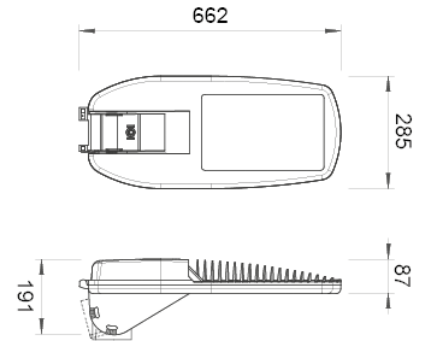

DATI TECNICI - TECHNICAL DATA

	CRI				IP	
220-240 V AC 50-60 Hz	75	CL II	DIE-CAST ALUMINIUM	8 - 8,70 Kg	66	0,19 m ²

VARIANTI - OPTIONS

Cod.	W	Temperatura colore Color temperature	nr LED	DIM	Flusso Luminoso Luminous flux	€
0006412243	27	4000 K	12	-	3050 lumen	
0006412243DIM	13	4000 K	12	√	1650 lumen	
	19				2300 lumen	
	27				3050 lumen	
0006424243	53	4000 K	24	-	6100 lumen	
	27				3300 lumen	
	37				4300 lumen	
0006424243DIM	53	4000 K	24	√	6100 lumen	
	80				9100 lumen	
	40				4950 lumen	
0006436243	80	4000 K	36	-	9100 lumen	
	56				6900 lumen	
	80				9100 lumen	
0006436243DIM	56	4000 K	36	√	6900 lumen	
	80				9100 lumen	
	106				12150 lumen	
0006448243	106	4000 K	48	-	12150 lumen	
	53				6600 lumen	
	75				9150 lumen	
0006448243DIM	75	4000 K	48	√	9150 lumen	
	106				12150 lumen	

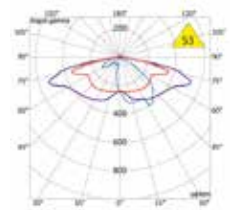
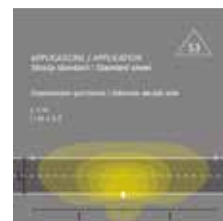

INDOOR

OUTDOOR

STRIP

ROAD

INDUSTRIAL

SATURN A



Armatura a led con ottica secondaria adatta all'illuminazione stradale e l'arredo urbano. Efficienza luminosa fino a 130 lumen/W. Regolazione della luminosità programmabile da software.

LED fixture with secondary optic for street and urban lighting, 130 lumen per watt efficiency. Light intensity controllable via software.

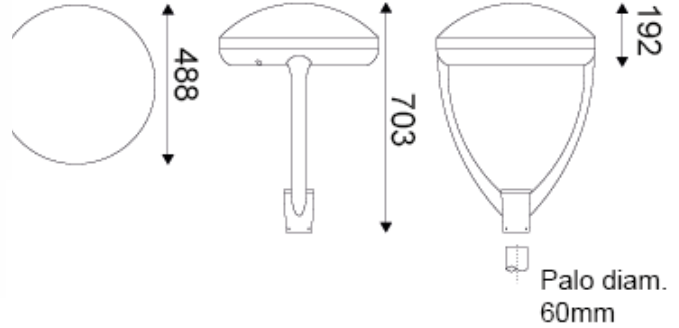

DATI TECNICI - TECHNICAL DATA



220-240 V AC
50-60 Hz

CRI

70



CL II



DIE-CAST
ALUMINIUM



11,50 Kg

IP

65



0,19 m²

VARIANTI - OPTIONS

Cod.	W	Temperatura colore Color temperature	nr LED	Flusso Luminoso Luminous flux	€
0006924349A	29	4000 K	24	3800 lumen	
	41			5100 lumen	
	56			6600 lumen	

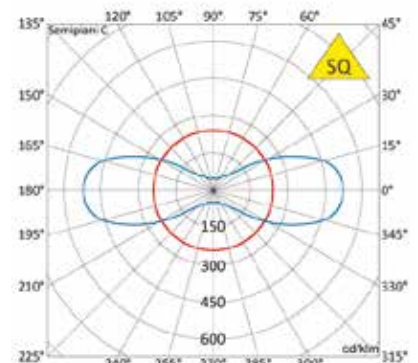

SATURN P



Armatura a led con ottica secondaria adatta all'illuminazione stradale e l'arredo urbano. Efficienza luminosa fino a 130 lumen/W. Regolazione della luminosità programmabile da software.

LED fixture with secondary optic for street and urban lighting. 130 lumen per watt efficiency. Light intensity controllable via software.

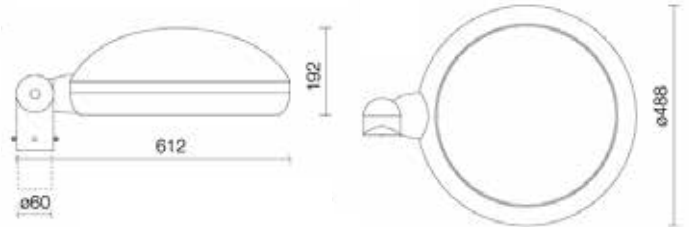

DATI TECNICI - TECHNICAL DATA



CRI
70



IP
65



VARIANTI - OPTIONS

Cod.	W	Temperatura colore Color temperature	nr LED	Flusso Luminoso Luminous flux	€
0006924343P	29	4000 K	24	3800 lumen	
	41			5100 lumen	
	56			6600 lumen	

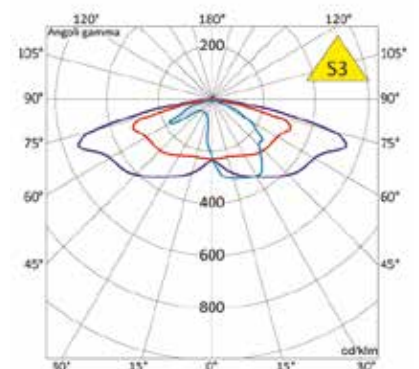

INDOOR

OUTDOOR

STRIP

ROAD

INDUSTRIAL

SATURN S



Armatura a led con ottica secondaria adatta all'illuminazione stradale e l'arredo urbano. Efficienza luminosa fino a 130 lumen/W. Regolazione della luminosità programmabile da software. Fornito con gancio di fissaggio.

LED fixture with secondary optic for street and urban lighting. 130 lumen per watt efficiency. Light intensity controllable via software. Supplied with fixation hook clamp.

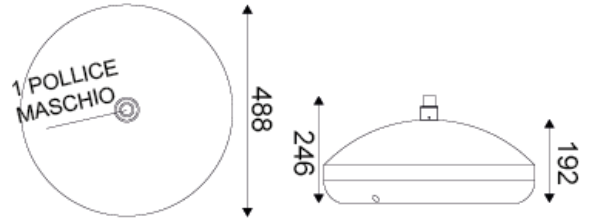

DATI TECNICI - TECHNICAL DATA



220-240 V AC
50-60 Hz

CRI

70



CL II



DIE-CAST
ALUMINIUM



9 Kg

IP

65



0,19 m²

VARIANTI - OPTIONS

Cod.	W	Temperatura colore Color temperature	nr LED	Flusso Luminoso Luminous flux	€
0006924343S	29	4000 K	24	3800 lumen	
	41			5100 lumen	
	56			6600 lumen	

ACCESSORI - ACCESSORIES

Cod. 000004031
Cilindro sospensione
SATURN S



incluso - included

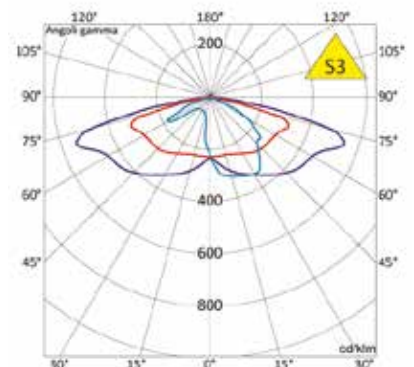

SATURN T



Armatura a led con ottica secondaria adatta all'illuminazione stradale e l'arredo urbano. Efficienza luminosa fino a 130 lumen/w. Regolazione della luminosità programmabile da software. Fornito con gancio di fissaggio per tesata.

LED fixture with secondary optic for street and urban lighting. 130 lumen per watt efficiency. Light intensity controllable via software. Supplied with fixation for suspension.

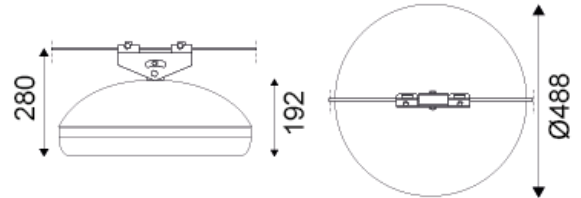

DATI TECNICI - TECHNICAL DATA



220-240 V AC
50-60 Hz

CRI

70



CL II



DIE-CAST
ALUMINIUM



11,50 Kg

IP

65



0,19 m²

VARIANTI - OPTIONS

Cod.	W	Temperatura colore Color temperature	nr LED	Flusso Luminoso Luminous flux	€
000692434T	29	4000 K	24	3800 lumen	
	41			5100 lumen	
	56			6600 lumen	

ACCESSORI - ACCESSORIES

Cod. 000004030
Tesata sospensione per
montaggio su fune acciaio



incluso - included

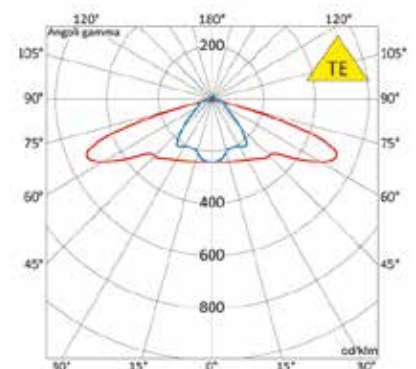

INDOOR

OUTDOOR

STRIP

ROAD

INDUSTRIAL



Le imprese hanno sempre più la necessità di impostare nuove politiche energetiche, in ambito industriale l'illuminazione a LED offre un grande ventaglio di soluzioni che permettono di ottenere un elevato risparmio nei costi di gestione. Le aree produttive, le zone di stoccaggio e gli uffici possono quindi essere riqualificati introducendo negli ambienti risparmio e allo stesso tempo maggior comfort lavorativo.

Companies have the need to set up new energy policies. The industrial LED lighting is offering a large range of solutions allowing significant savings on maintenance and operating costs. In some parking areas where motor traffic, pedestrians and cyclists find themselves face-to-face with each other, lighting needs to particularly take care of safety aspects.



INDUSTRIALE





SEMPLICITÀ E FLESSIBILITÀ Modulo Gilbert è il nuovo concetto di illuminazione modulare progettato e realizzato per molteplici applicazioni. La nuova gamma di illuminatori consente di illuminare perfettamente ogni ambiente. L'estrema flessibilità permette a Modulo Gilbert di sostituire la maggior parte dei proiettori industriali di vecchia generazione.

SIMPLICITY AND FLEXIBILITY Modulo Gilbert is the new concept of modular lighting designed and built for multiple applications. The new range of illuminators allows perfect illumination of every environment. The extreme flexibility allows Modulo Gilbert to replace most of the old generation industrial projectors.





MODULO GILBERT



MODULO 2 GILBERT 1000 VT



Apparecchio industriale, con 2 moduli LED ad alta potenza, per interno, con diffusore in vetro krizet. Consumo massimo 170 W.

Industrial luminaire made with 2 high power LEDs modules, for indoor use, with krizet diffusion glass. Maximum power consumption 170 W.

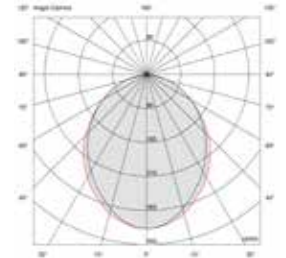

DATI TECNICI - TECHNICAL DATA



CRI
80



IP
54
USO INTERNO

VARIANTI - OPTIONS

Cod.		Temperatura colore Color temperature	Flusso Luminoso Luminous flux	€
0618356964	150/170 W	4000K	22500/25200 lumen	

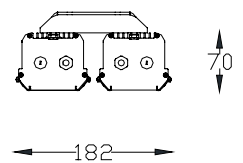
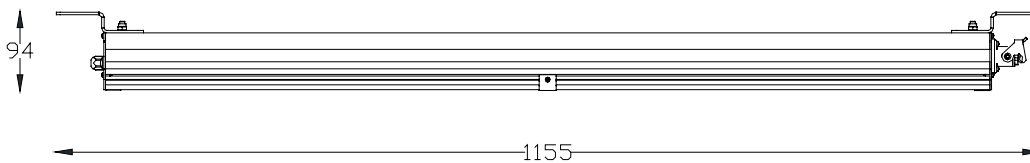

MODULO 2 GILBERT 1000 PC



Apparecchio industriale, con 2 moduli LED ad alta potenza, per interno, con diffusore in policarbonato. Consumo massimo 170 W.

Industrial luminaire made with 2 high power LEDs modules, for indoor use, with polycarbonate diffuser. Maximum power consumption 170 W.

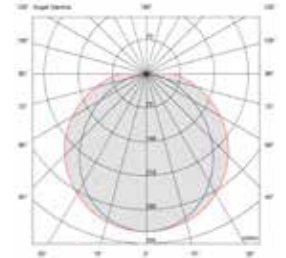

DATI TECNICI - TECHNICAL DATA



220-240 V AC

CRI

80



CL I



ALUMINIUM



7 Kg

IP

54

USO INTERNO

VARIANTI - OPTIONS

Cod.		Temperatura colore Color temperature	Flusso Luminoso Luminous flux	€
0618355864	150/170 W	4000K	22500/25200 lumen	

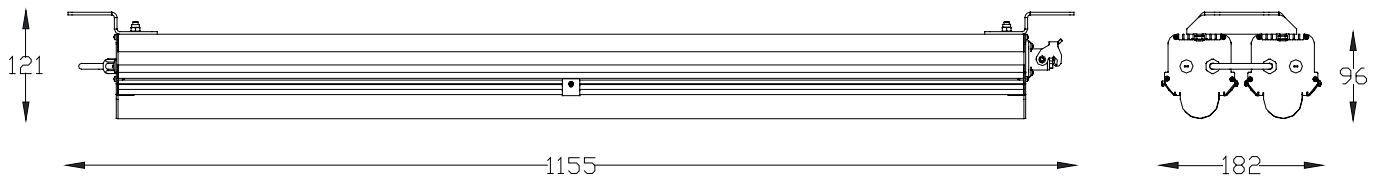

INDOOR

OUTDOOR

STRIP

ROAD

INDUSTRIAL

MODULO 5 GILBERT 500 VT

Apparecchio industriale, orientabile con 5 moduli LED ad alta potenza, per interno, con diffusore in vetro krizet. Consumo massimo 235 W.

Industrial adjustable luminaire made with 5 high power LEDs modules, for indoor use, with krizet diffusion glass. Maximum power consumption 235 W.

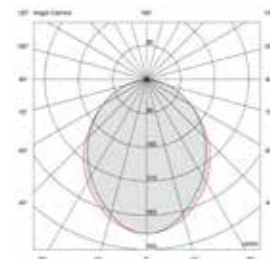

DATI TECNICI - TECHNICAL DATA



CRI
80



IP
54
USO INTERNO

VARIANTI - OPTIONS

Cod.		Temperatura colore Color temperature	Flusso Luminoso Luminous flux	€
0620356864	235 W	4000K	33900 lumen	

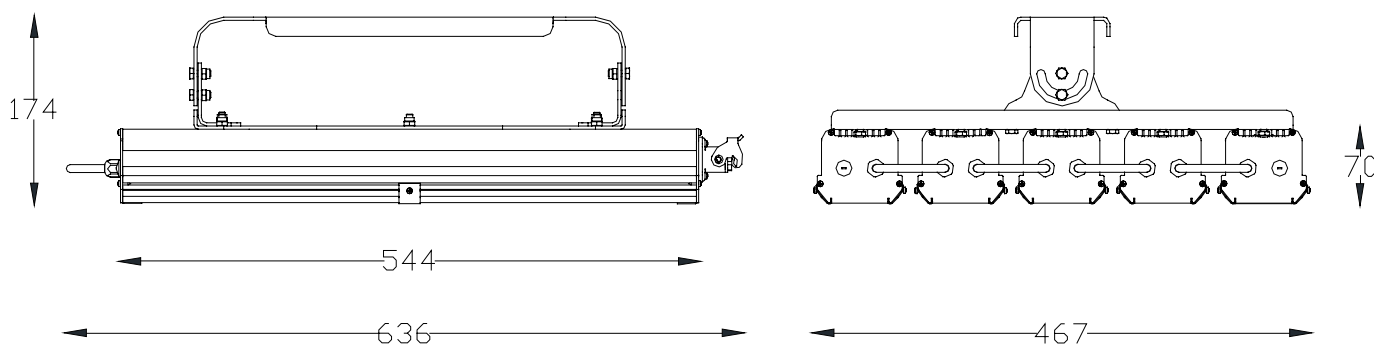

MODULO 5 GILBERT 500 PC



Apparecchio industriale, orientabile con 5 moduli LED ad alta potenza, per interno, con diffusore in policarbonato. Consumo massimo 235 W.

Industrial adjustable luminaire made with 5 high power LEDs modules, for indoor use, with polycarbonate diffuser. Maximum power consumption 235 W.

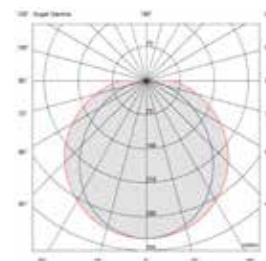

DATI TECNICI - TECHNICAL DATA

220-240 V AC

CRI
80



C_{LI}



ALUMINIUM

8,5 Kg

IP
54
USO INTERNO

VARIANTI - OPTIONS

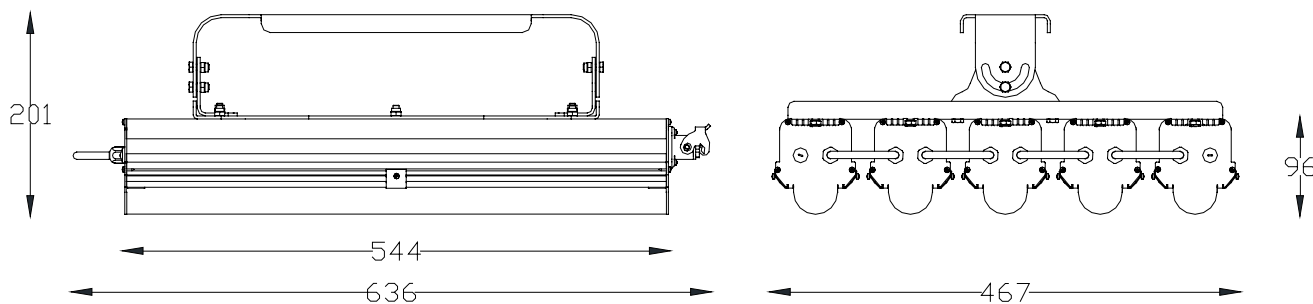
Cod.		Temperatura colore Color temperature	Flusso Luminoso Luminous flux	€
0620355864	235 W	4000K	33900 lumen	



INDOOR

OUTDOOR

STRIP

ROAD

INDUSTRIAL

MODULO 4 GILBERT 500 VT

Apparecchio industriale, orientabile con 4 moduli LED ad alta potenza, per interno, con diffusore in vetro krizet. Consumo massimo 188 W.

Industrial adjustable luminaire made with 4 high power LEDs modules, for indoor use, with krizet diffusion glass. Maximum power consumption 188 W.

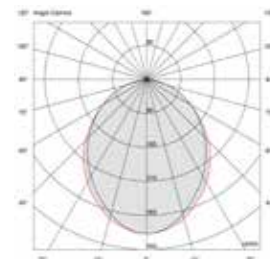

DATI TECNICI - TECHNICAL DATA

220-240 V AC

CRI
80



CRI



ALUMINIUM

6,5 Kg

IP
54
USO INTERNO

VARIANTI - OPTIONS

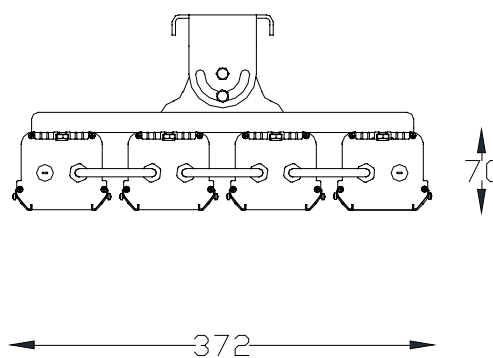
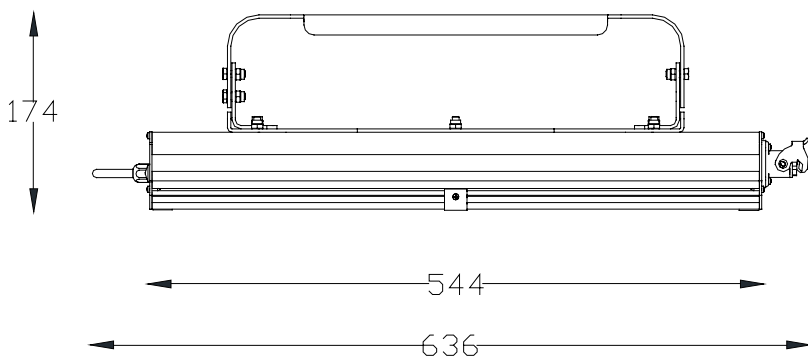
Cod.		Temperatura colore Color temperature	Flusso Luminoso Luminous flux	€
0616355764	188 W	4000K	27100 lumen	



MODULO 4 GILBERT 500 PC



Apparecchio industriale, orientabile con 4 moduli LED ad alta potenza, per interno, con diffusore in policarbonato. Consumo massimo 188 W.

Industrial adjustable luminaire made with 4 high power LEDs modules, for indoor use, with polycarbonate diffuser. Maximum power consumption 188 W.

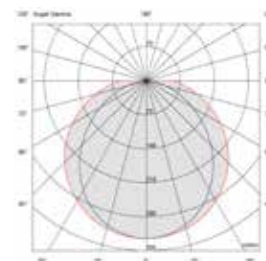

DATI TECNICI - TECHNICAL DATA

220-240 V AC

CRI
80



CRI



ALUMINIUM

6,5 Kg

IP
54
USO INTERNO

VARIANTI - OPTIONS

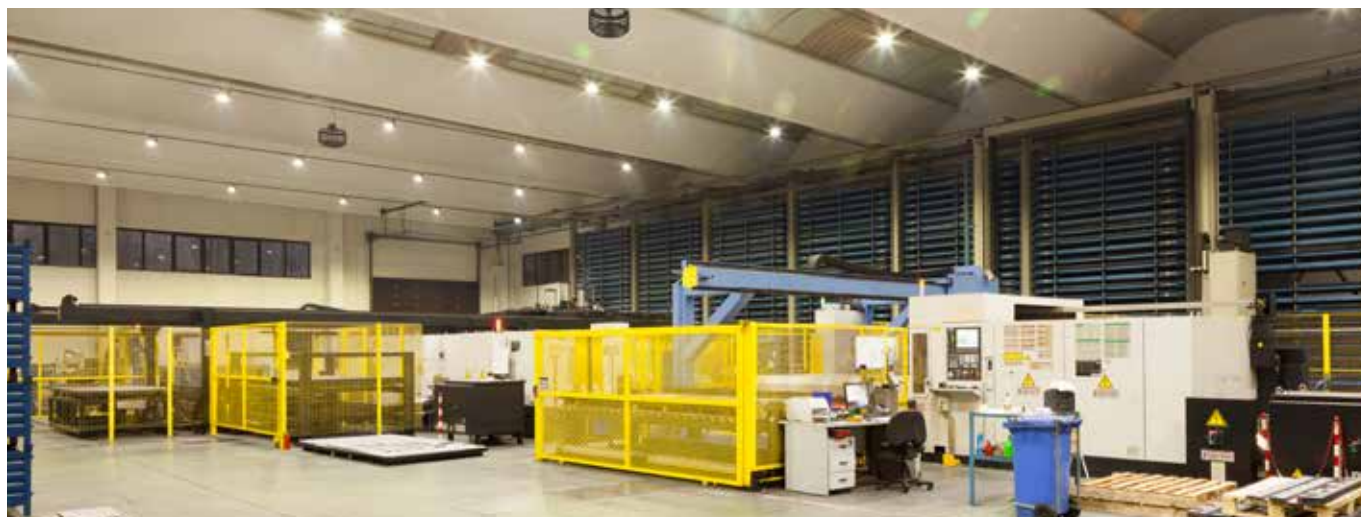
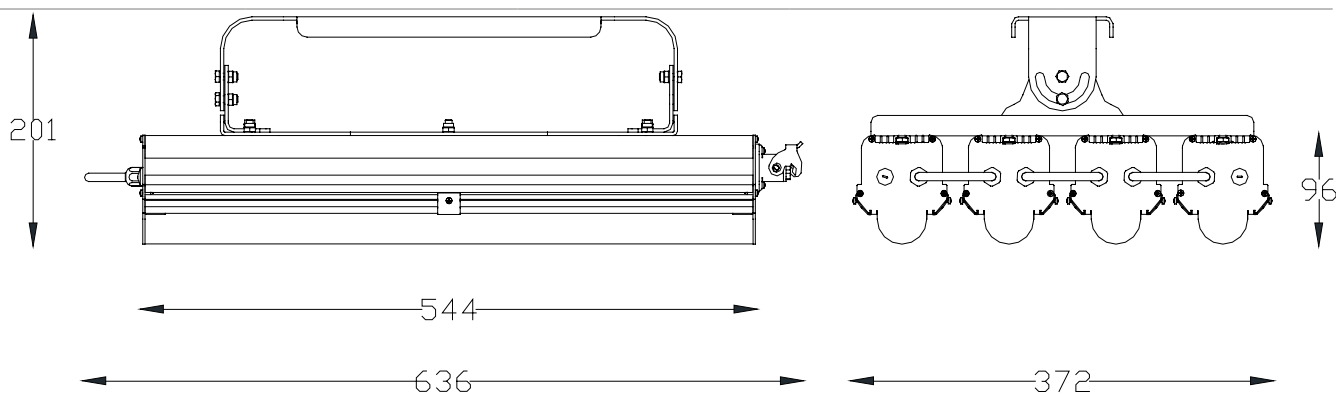
Cod.		Temperatura colore Color temperature	Flusso Luminoso Luminous flux	€
0616355864	188 W	4000K	27100 lumen	



INDOOR

OUTDOOR

STRIP

ROAD

INDUSTRIAL

MODULO 3 GILBERT 500 VT

Apparecchio industriale, orientabile con 3 moduli LED ad alta potenza, per interno, con diffusore in vetro krizet. Consumo massimo 140 W.

Industrial adjustable luminaire made with 3 high power LEDs modules, for indoor use, with krizet diffusion glass. Maximum power consumption 140 W.

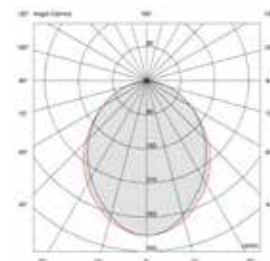

DATI TECNICI - TECHNICAL DATA



CRI
80



IP
54
USO INTERNO

VARIANTI - OPTIONS

Cod.		Temperatura colore Color temperature	Flusso Luminoso Luminous flux	€
0633356864	140 W	4000K	20300 lumen	

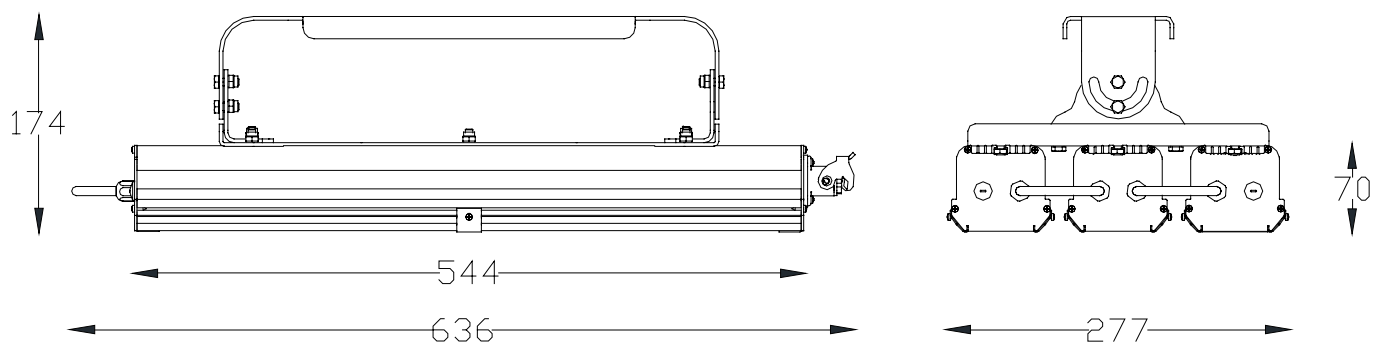

MODULO 3 GILBERT 500 PC



Apparecchio industriale, orientabile con 3 moduli LED ad alta potenza, per interno, con diffusore in policarbonato. Consumo massimo 140 W.

Industrial adjustable luminaire made with 3 high power LEDs modules, for indoor use, with polycarbonate diffuser. Maximum power consumption 140 W.

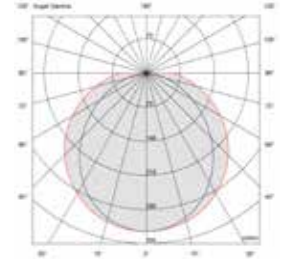

DATI TECNICI - TECHNICAL DATA



CRI
80



IP
54
USO INTERNO

VARIANTI - OPTIONS

Cod.		Temperatura colore Color temperature	Flusso Luminoso Luminous flux	€
0633355864	140 W	4000K	20300 lumen	

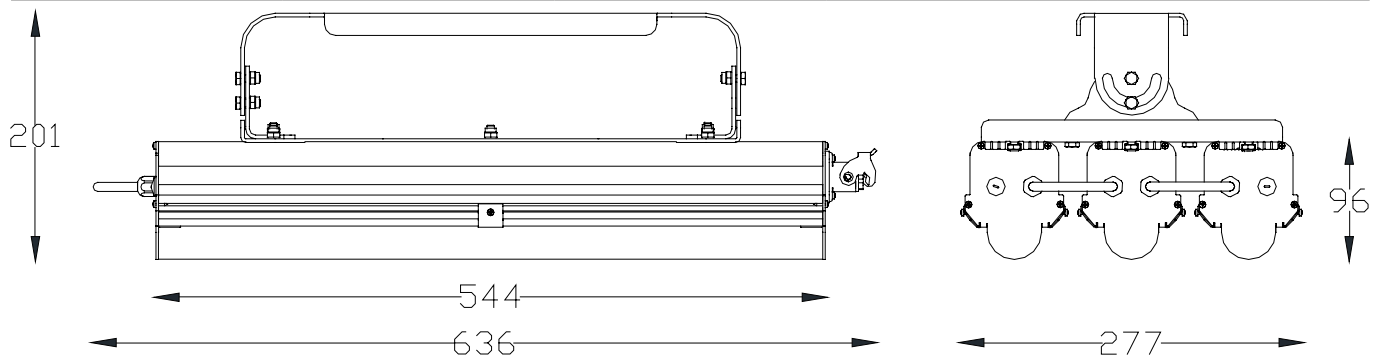



RICERCA, SVILUPPO, RISPARMIO Sono gli obiettivi di GILBERT. Molti sono gli impianti di illuminazione ormai troppo vecchi. L'illuminazione che in origine era efficiente e moderna oggi è diventata obsoleta e i consumi energetici troppo alti. Il relamping con proiettori LED ad elevata efficienza garantisce il totale abbattimento dei costi di manutenzione e un importante risparmio di energia elettrica.

RESEARCH, DEVELOPMENT, ENERGY SAVING These are the targets of GILBERT. There are too many old lighting systems. Fixtures that was originally efficient and modern today has become obsolete and their energy consumption is too high. The relamping with high efficiency LED lamps ensures total reduction of maintenance costs and significant savings in electricity.





GILBERT



GILBERT 1500 VT

Lampada a LED ad alta potenza, per interno, con diffusore in vetro krizet. I consumi vanno da 58 W a 140W a seconda del modello e delle esigenze.

High power LEDs lamp, for indoor use, with krizet diffusion glass. Power consumption goes from 58 W to 140 W depending on model and need.

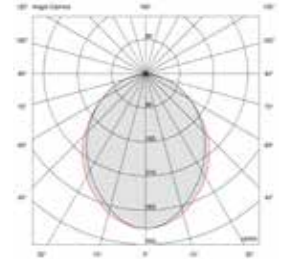

INDOOR

OUTDOOR

DATI TECNICI - TECHNICAL DATA



CRI
80



IP
54

USO INTERNO

VARIANTI - OPTIONS

Cod.	DIM		Temperatura colore Color temperature	Flusso Luminoso Luminous flux	sostituzione	€
9611351291	-	58/68 W	6500K	8.900/9.700 lumen	neon 2 x 58	
9611356964	-	58/68 W	4000K	8.900/9.700 lumen	neon 2 x 58	
9611356990	-	58/68 W	3000K*	8.400/9.200 lumen	neon 2 x 58	
9615356991	-	70/80 W	6500K*	11.300/12.700 lumen	-	
9615356964	-	70/80 W	4000K	11.300/12.700 lumen	-	
9615356990	-	70/80 W	3000K*	10.700/12.000 lumen	-	
9616356991	✓	80 W	6500K*	12.700 lumen	-	
9616356964	✓	80 W	4000K	12.700 lumen	-	
9616356990	✓	80 W	3000K*	12.000 lumen	-	
9630356991	-	96 W	6500K*	15.000 lumen	-	
9630356964	-	96 W	4000K	15.000 lumen	-	
9630356990	-	96 W	3000K*	14.000 lumen	-	
9617356964	-	127 W	4000K	18.900 lumen	-	
9618356964	-	140 W	4000K	20.300 lumen	-	

ACCESSORI - ACCESSORIES

Cod. 1600770000
squadrette x soffitto fisse



Cod. 1600780000
squadrette x soffitto regolabili



Cod. 1600790000
kit staffe rotazione INOX



* Disponibili solo su richiesta - Available only on request

INDUSTRIALE

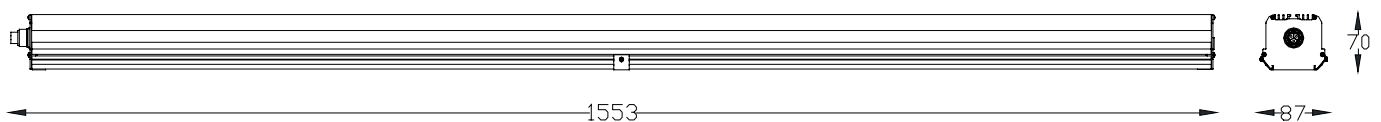

GILBERT 1500 PC



Lampada a LED ad alta potenza, per interno, con diffusore in policarbonato. I consumi vanno da 58 W a 140W a seconda del modello e delle esigenze.

High power LEDs lamp, for indoor use, with polycarbonate diffuser. Power consumption goes from 58 W to 140 W depending on model and need.

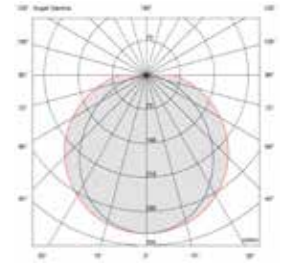

DATI TECNICI - TECHNICAL DATA



CRI
80



IP
54
USO INTERNO

VARIANTI - OPTIONS

Cod.	DIM		Temperatura colore Color temperature	Flusso Luminoso Luminous flux	sostituzione	€
9612351291	-	58/68 W	6500K	8.900/9.700 lumen	neon 2 x 58	
9612351264	-	58/68 W	4000K	8.900/9.700 lumen	neon 2 x 58	
9612351290	-	58/68 W	3000K*	8.400/9.200 lumen	neon 2 x 58	
9616351291	-	70/80 W	6500K*	11.300/12.700 lumen	-	
9616351264	-	70/80 W	4000K	11.300/12.700 lumen	-	
9616351290	-	70/80 W	3000K*	10.700/12.000 lumen	-	
9616356791	✓	80 W	6500K*	12.700 lumen	-	
9616356764	✓	80 W	4000K	12.700 lumen	-	
9616356790	✓	80 W	3000K*	12.000 lumen	-	
9630351291	-	96 W	6500K*	15.000 lumen	-	
9630351264	-	96 W	4000K	15.000 lumen	-	
9630351290	-	96 W	3000K*	14.000 lumen	-	
9617355864	-	127 W	4000K	18.900 lumen	-	
9618355864	-	140 W	4000K	20.300 lumen	-	

ACCESSORI - ACCESSORIES

Cod. 1600770000
squadrette x soffitto fisse



Cod. 1600780000
squadrette x soffitto regolabili



Cod. 1600790000
kit staffe rotazione INOX



* Disponibili solo su richiesta - Available only on request

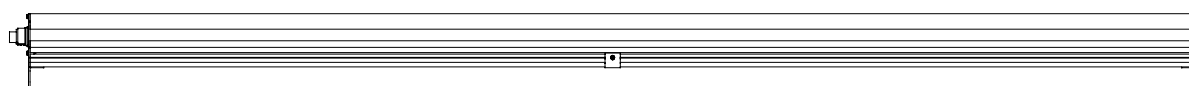

1555

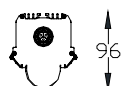

87

INDOOR

OUTDOOR

STRIP

ROAD

INDUSTRIAL

GILBERT 1000 VT

INDOOR

OUTDOOR



Lampada a LED ad alta potenza, per interno, con diffusore in vetro krizet. I consumi vanno da 35 W a 80 W a seconda del modello e delle esigenze.

High power LEDs lamp, for indoor use, with krizet diffusion glass. Power consumption goes from 35 W to 80 W depending on model and need.

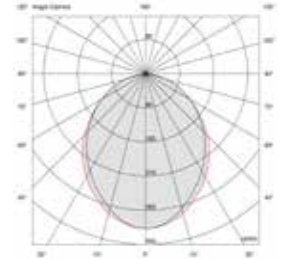

DATI TECNICI - TECHNICAL DATA



VARIANTI - OPTIONS

ACCESSORI - ACCESSORIES

Cod.	DIM		Temperatura colore Color temperature	Flusso Luminoso Luminous flux	sostituzione	€
9609356991	-	35 W	6500K	6.100 lumen	neon 2x36	
9609356964	-	35 W	4000K	6.100 lumen	neon 2x36	
9609356990	-	35 W	3000K*	5.800 lumen	neon 2x36	
9613356991	-	58/68 W	6500K*	8.900/9.700 lumen	neon 2x58	
9613356964	-	58/68 W	4000K	8.900/9.700 lumen	neon 2x58	
9613356990	-	58/68 W	3000K*	8.400/9.200 lumen	neon 2x58	
9614356964	-	70/80 W	4000K	10.500/11.500 lumen	-	

Cod. 1600770000
squadrette x soffitto fisse



Cod. 1600780000
squadrette x soffitto regolabili



Cod. 1600790000
kit staffe rotazione INOX



* Disponibili solo su richiesta - Available only on request



STRIP

STRADALE

INDUSTRIALE



GILBERT 1000 PC



Lampada a LED ad alta potenza, per interno, con diffusore in policarbonato. I consumi vanno da 35 W a 80 W a seconda del modello e delle esigenze.

High power LEDs lamp, for indoor use, with polycarbonate diffuser. Power consumption goes from 35 W to 80 W depending on model and need.

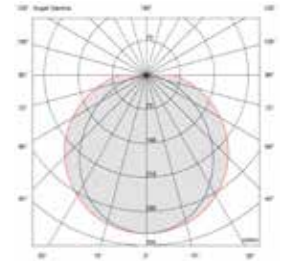

DATI TECNICI - TECHNICAL DATA



CRI
80



IP
54
USO INTERNO

VARIANTI - OPTIONS

ACCESSORI - ACCESSORIES

Cod.	DIM		Temperatura colore Color temperature	Flusso Luminoso Luminous flux	sostituzione	€
9610350291	-	35 W	6500K	6.100 lumen	neon 2x36	
9610350264	-	35 W	4000K	6.100 lumen	neon 2x36	
9610350290	-	35 W	3000K*	5.800 lumen	neon 2x36	
9613350291	-	58/68 W	6500K*	8.900/9.700 lumen	neon 2x58	
9613350264	-	58/68 W	4000K	8.900/9.700 lumen	neon 2x58	
9613350290	-	58/68 W	3000K*	8.400/9.200 lumen	neon 2x58	
9614355864	-	70/80 W	4000K	10.500/11.500 lumen	-	

Cod. 1600770000
squadrette x soffitto fisse



Cod. 1600780000
squadrette x soffitto regolabili



Cod. 1600790000
kit staffe rotazione INOX



* Disponibili solo su richiesta - Available only on request

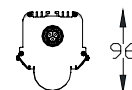
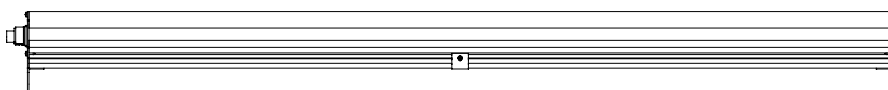

1069

87



INDOOR

OUTDOOR

STRIP

ROAD

INDUSTRIAL

GILBERT 500 VT



Lampada a LED ad alta potenza, per interno, on diffusore in vetro krizet. I consumi vanno da 20 W a 47 W a seconda del modello e delle esigenze.

High power LEDs lamp, for indoor use, with krizet diffusion glass. Power consumption goes from 20 W to 47 W depending on model and need.

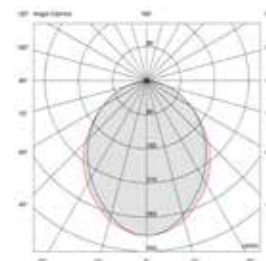

DATI TECNICI - TECHNICAL DATA



VARIANTI - OPTIONS

Cod.	DIM		Temperatura colore Color temperature	Flusso Luminoso Luminous flux	sostituzione	€
9605356992	-	20/28 W	6500K	3.300/4.300 lumen	neon 1 x 36	
9605356964	-	20/28 W	4000K	3.300/4.300 lumen	neon 1 x 36	
9605356990	-	20/28 W	3000K*	3.100/4.600 lumen	neon 1 x 36	
9610356991	-	33 W	6500K	5.000 lumen	neon 1 x 58	
9610356964	-	33 W	4000K	5.000 lumen	neon 1 x 58	
9610356990	-	33 W	3000K*	4.700 lumen	neon 1 x 58	
9612350091	-	47 W	6500K*	6.800 lumen	neon 2 x 58	
9612350064	-	47 W	4000K	6.800 lumen	neon 2 x 58	
9612350090	-	47 W	3000K*	6.500 lumen	neon 2 x 58	

ACCESSORI - ACCESSORIES

Cod. 1600770000
squadrette x soffitto fisse



Cod. 1600780000
squadrette x soffitto regolabili



Cod. 1600790000
kit staffe rotazione INOX



* Disponibili solo su richiesta - Available only on request

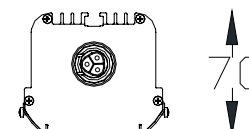
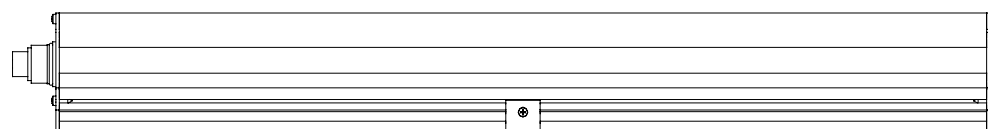

GILBERT 500 PC



Lampada a LED ad alta potenza, per interno, con diffusore in policarbonato. I consumi vanno da 20 W a 47 W a seconda del modello e delle esigenze.

High power LEDs lamp, for indoor use, with polycarbonate diffuser. Power consumption goes from 20 W to 47 W depending on model and need.

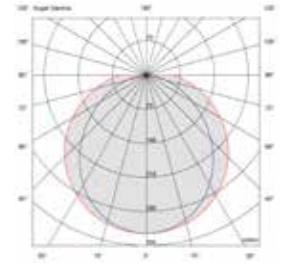

DATI TECNICI - TECHNICAL DATA



CRI
80



IP
54
USO INTERNO

VARIANTI - OPTIONS

Cod.	DIM		Temperatura colore Color temperature	Flusso Luminoso Luminous flux	sostituzione	€
9605351691	-	20/28 W	6500K	3.300/4.300 lumen	neon 1 x 36	
9605351664	-	20/28 W	4000K	3.300/4.300 lumen	neon 1 x 36	
9605351690	-	20/28 W	3000K*	3.100/4.600 lumen	neon 1 x 36	
9610351691	-	33 W	6500K	5.000 lumen	neon 1 x 58	
9610351664	-	33 W	4000K	5.000 lumen	neon 1 x 58	
9610351690	-	33 W	3000K*	4.700 lumen	neon 1 x 58	
9612351691	-	47 W	6500K*	6.800 lumen	neon 2 x 58	
9612351664	-	47 W	4000K	6.800 lumen	neon 2 x 58	
9612351690	-	47 W	3000K*	6.500 lumen	neon 2 x 58	

ACCESSORI - ACCESSORIES

Cod. 1600770000
squadrette x soffitto fisse



Cod. 1600780000
squadrette x soffitto regolabili



Cod. 1600790000
kit staffe rotazione INOX



* Disponibili solo su richiesta - Available only on request

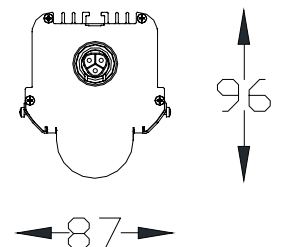
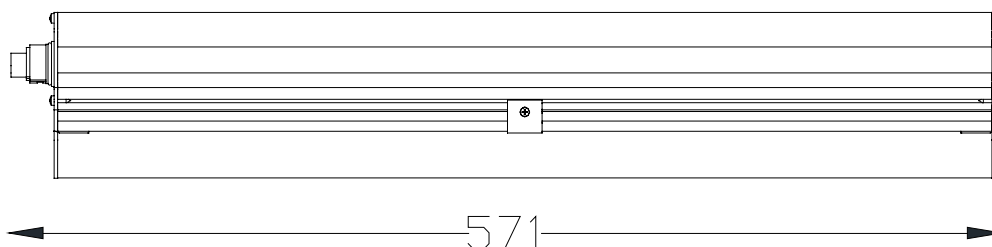



LUCE IN AMBIENTI CRITICI Questo È il vero obiettivo della linea MODULO GILBERT l'obiettivo in questo caso era di riuscire a realizzare una serie di proiettori capaci di **RISOLVERE** i problemi legati alle condizioni estreme di utilizzo, ecco che questa linea garantisce la durata delle prestazioni anche in ambienti con temperature di lavoro estreme. Grazie alla ottiche concentranti e alla potenza trovano utilizzo , anche, in tutte quelle applicazioni in cui il posizionamento del proiettore sia estremamente alto.

LIGHT IN CRITICAL ENVIRONMENTS This is the real goal of the MODULO line. The target in this case was to be able to realize a series of projectors capable of **SOLVING** the problems related to extreme conditions of use, this line guarantees the duration of the performances even in environments with extreme working temperatures. Thanks to the concentric optics and to the power they are used, also, in all those applications where the positioning of the projector is extremely high.



A large industrial warehouse with a green overlay and a pallet truck in the foreground. The warehouse has a high ceiling with multiple rows of track lighting. In the foreground, a yellow and black pallet truck is parked on a grey concrete floor. Several pallets of cardboard boxes are scattered throughout the space. In the background, there are metal structures and a blue sign with the number '15'.

MODULO

MODULO 640

INDOOR



Apparecchio industriale orientabile, a 640 LED ad alta potenza, per l'illuminazione d'interni industriali con corpo in alluminio. Equivalente a faro a scarica da 400W. La versione dimmerabile utilizza il sistema DALI. Protezione Termica Retroattiva (PTR).

640 LEDs adjustable fixture for ceiling installation, for industrial indoor illumination with aluminium body. Equivalent to 400W discharge lamp. The dimmable version uses DALI system. Thermal Retroactive Protection (PTR).

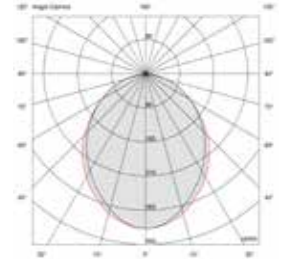



OUTDOOR

DATI TECNICI - TECHNICAL DATA

		CRI				IP 54	PTR
220-240 V AC	180/220 W	80	CL I	ALUMINIUM	10 Kg	USO INTERNO	

VARIANTI - OPTIONS

	Cod.	DIM		Temperatura colore Color temperature	Flusso Luminoso Luminous flux	€
ORIENTABILE						
	0618356864	-	180/220 W	4000K	30200/36000 lumen	
	0618356764	✓	180/220 W	4000K	30200/36000 lumen	
FISSO						
	0618353164	-	180/220 W	4000K	30200/36000 lumen	
	0619356764	✓	180/220 W	4000K	30200/36000 lumen	

STRADALE

INDUSTRIALE

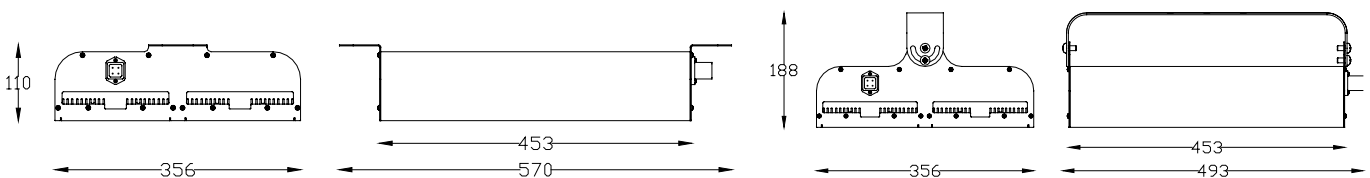

MODULO 36



Apparecchio industriale orientabile, a 144 LED ad alta potenza, per l'illuminazione d'interni industriali con corpo in alluminio. Equivalente a faro a scarica da 400W fascio stretto. La versione dimmerabile utilizza il sistema DALI. Protezione Termica Retroattiva (PTR).

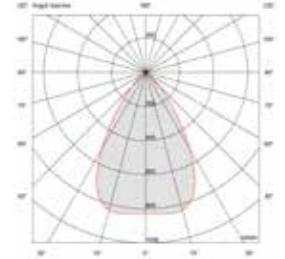

144 LEDs adjustable fixture for ceiling installation, for industrial indoor illumination with aluminium body. Equivalent to 400W discharge lamp narrow spot. The dimmable version uses DALI system. Thermal Retroactive Protection (PTR).



DATI TECNICI - TECHNICAL DATA

		CRI				IP	PTR
220-240 V AC	180/220 W	80	CL I	ALUMINIUM	10 Kg	54	
						USO INTERNO	

VARIANTI - OPTIONS

	Cod.	DIM		Temperatura colore Color temperature	Flusso Luminoso Luminous flux	Apertura Fascio Beam angle	€
ORIENTABILE							
	0616351264	-	180/220 W	4000K	22650/27400 lumen	65°	
	0616356764	✓	180/220 W	4000K	22650/27400 lumen	65°	
FISSO							
	0616353164	-	180/220 W	4000K	22650/27400 lumen	65°	
	0617356764	✓	180/220 W	4000K	22650/27400 lumen	65°	

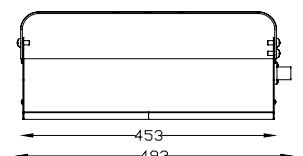
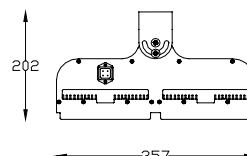
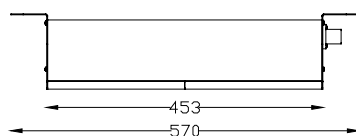
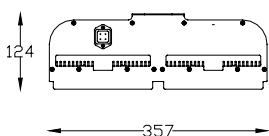

MODULO 320



Apparecchio industriale orientabile, a 320' LED ad alta potenza, per l'illuminazione d'interni industriali con corpo in alluminio. Equivalente a faro a scarica da 250W. La versione dimmerabile utilizza il sistema DALI. Protezione Termica Retroattiva (PTR).

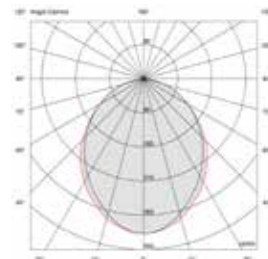

320 LEDs adjustable fixture for ceiling installation, for industrial indoor illumination with aluminium body. Equivalent to 250W discharge lamp. The dimmable version uses DALI system. Thermal Retroactive Protection (PTR).



DATI TECNICI - TECHNICAL DATA

		CRI				IP 54	PTR
220-240 V AC	116 W	80	CL I	ALUMINIUM	5,5 Kg	USO INTERNO	

VARIANTI - OPTIONS

	Cod.	DIM		Temperatura colore Color temperature	Flusso Luminoso Luminous flux	€
ORIENTABILE						
	0616356864	-	116 W	4000K	18350 lumen	
	0617806764	✓	116 W	4000K	18350 lumen	
FISSO						
	0616350064	-	116 W	4000K	18350 lumen	
	0616806764	✓	116 W	4000K	18350 lumen	

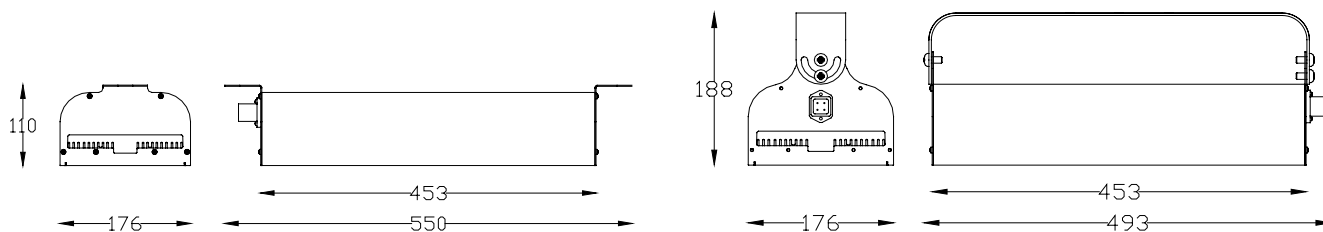

MODULO 18



Apparecchio industriale orientabile, a 72 LED ad alta potenza (18 Multichip), per l'illuminazione d'interni industriali con corpo in alluminio. Equivalente a faro a scarica da 250W fascio stretto. La versione dimmerabile utilizza il sistema DALI. Protezione Termica Retroattiva (PTR).

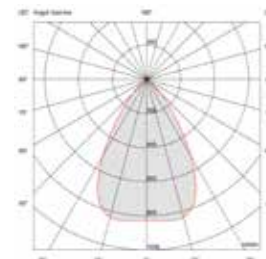

72 LEDs (18 Multichip) adjustable fixture for ceiling installation, for industrial indoor illumination with aluminium body. Equivalent to 250W discharge lamp narrow spot. The dimmable version uses DALI system. Thermal Retroactive Protection (PTR).



DATI TECNICI - TECHNICAL DATA



VARIANTI - OPTIONS

	Cod.	DIM		Temperatura colore Color temperature	Flusso Luminoso Luminous flux	Apertura Fascio Beam angle	€
ORIENTABILE							
	0612351264	-	116 W	4000K	14000 lumen	65°	
	0612356764	✓	116 W	4000K	14000 lumen	65°	
FISSO							
	0612353164	-	116 W	4000K	14000 lumen	65°	
	0612806764	✓	116 W	4000K	14000 lumen	65°	

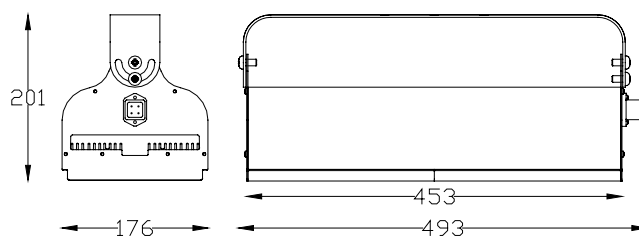
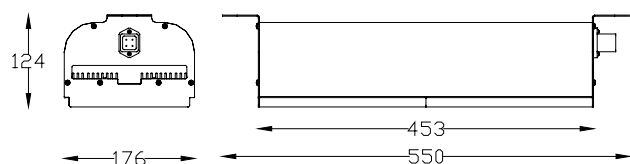

MODULO 160



Apparecchio a 160 LED ad alta potenza orientabile, equivalente a doppio tubo al neon 2x58w, per interno.

160 high power LEDs adjustable fixture for ceiling installation equivalent to double neon tube 2x58W for inside use.

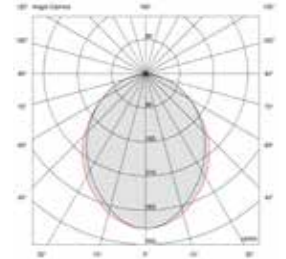

INDOOR

OUTDOOR

STRIP



STRADALE

INDUSTRIALE

DATI TECNICI - TECHNICAL DATA

		CRI				IP
220-240 V AC	46 - 58 W	80	CL I	ALUMINIUM	2,3 Kg	54 USO INTERNO

VARIANTI - OPTIONS

	Cod.		Temperatura colore Color temperature	Flusso Luminoso Luminous flux	€
ORIENTABILE					
	0613356864	58/70 W	4000K	9050/10750 lumen	
FISSO					
	0613353164	58/70 W	4000K	9050/10750 lumen	

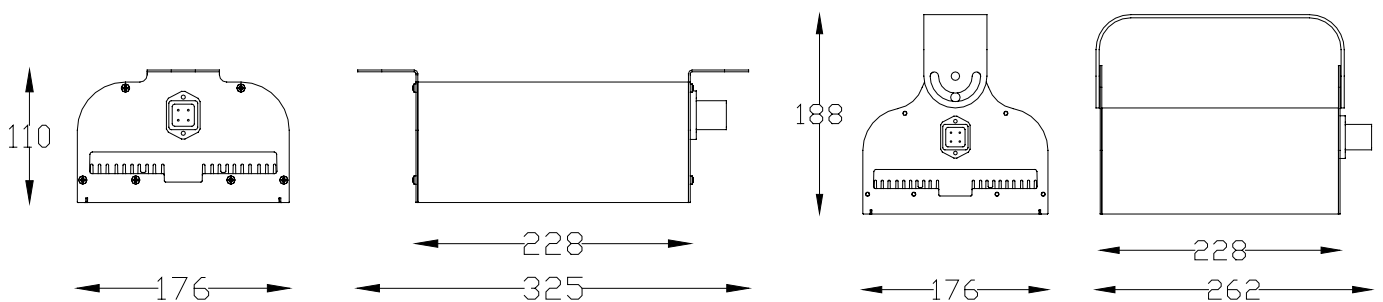

MODULO 9



Apparecchio a 36 LED (9 multichip) ad alta potenza orientabile, per interno.

36 high power LEDs (9 multichip) adjustable fixture for ceiling installation, for inside use.

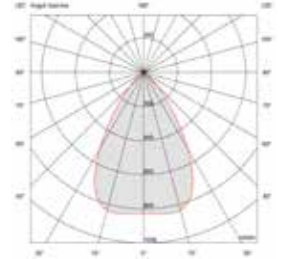

DATI TECNICI - TECHNICAL DATA

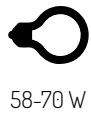

VARIANTI - OPTIONS

	Cod.		Temperatura colore Color temperature	Flusso Luminoso Luminous flux	Apertura Fascio Beam angle	€
ORIENTABILE						
	0613350064	58/70 W	4000K	6750/8100 lumen	65°	
FISSO						
	0613716564	58/70 W	4000K	6750/8100 lumen	65°	

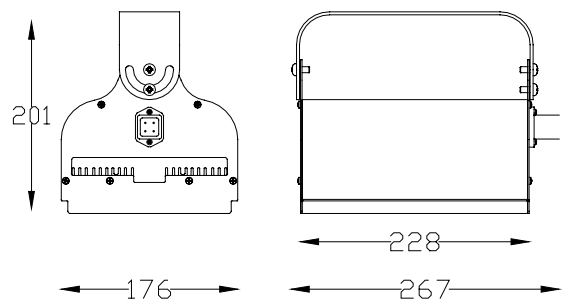
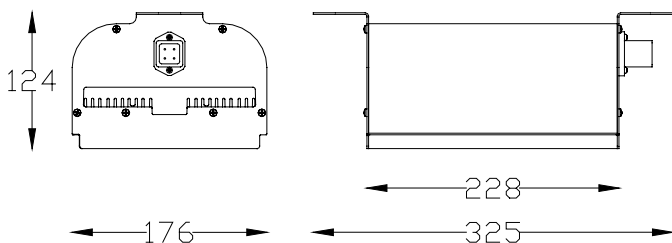



Ecco la risposta per illuminare ampie aree esterne in modo semplice e con costi contenuti. Led di ultima generazione abbinati ad ottiche, tutto racchiuso in un corpo progettato per resistere alle intemperie. Le differenti ottiche e le varie potenze disponibili consentono l'installazione in ogni contesto applicativo.

Here is the answer to illuminate large outdoor areas easily and with low costs. LEDs of the latest generation combined with special optics, all enclosed in a body designed to withstand the most "persistent" weather. The different optics and the various available powers allow installation in every application context.





MIRA 

MIRA 150

IP
65



Apparecchio a 320 LED ad alta potenza, per l'illuminazione di esterni industriali con corpo in pressofusione di alluminio. Consigliato per sostituzione 400W Simmetrico. Protezione Termica Retroattiva (PTR).

320 LEDs high power fixture for outdoor industrial illumination, with die-cast aluminium body. suggested for replacement of symmetrical 400W discharged lamp. Thermal Retroactive Protection (PTR).

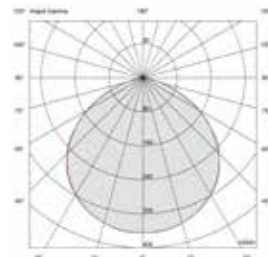

DATI TECNICI - TECHNICAL DATA

		CRI				IP	PTR
220-240 V AC	130/150 W	80	CL I	DIE-CAST ALUMINIUM	5 Kg	65	

VARIANTI - OPTIONS

Cod.		Temperatura colore Color temperature	Flusso Luminoso Luminous flux	€
9717561264	130/150 W	4000K	20800/23500 lumen	

ACCESSORI - ACCESSORIES

Cod. SD4319
traversa testa palo 25 cm

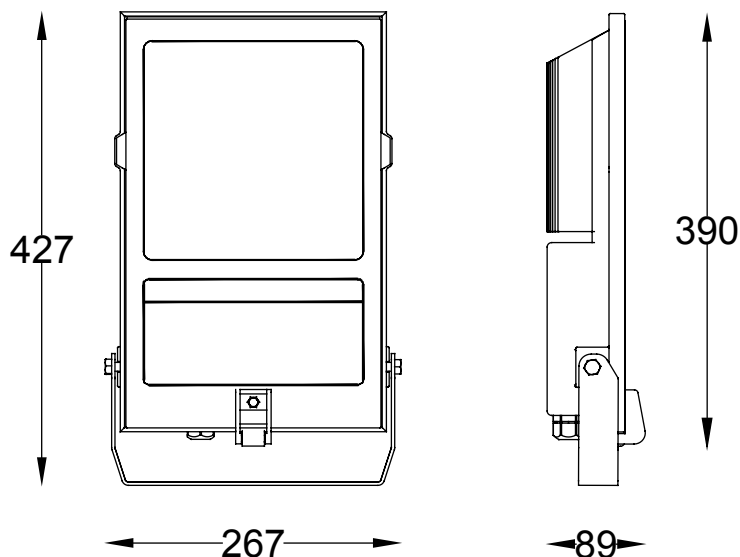

MIRA 150

IP 65



Apparecchio a 72 LED (18 led multichip) ad alta potenza, per l'illuminazione di esterni industriali con corpo in pressofusione di alluminio. Consigliato per sostituzione 400W fascio stretto. Protezione Termica Retroattiva (PTR).

72 LEDs (18 led multichip) high power fixture for outdoor industrial illumination, with die-cast aluminium body. suggested for replacement of narrow beam 400W discharged lamp. Thermal Retroactive Protection (PTR).

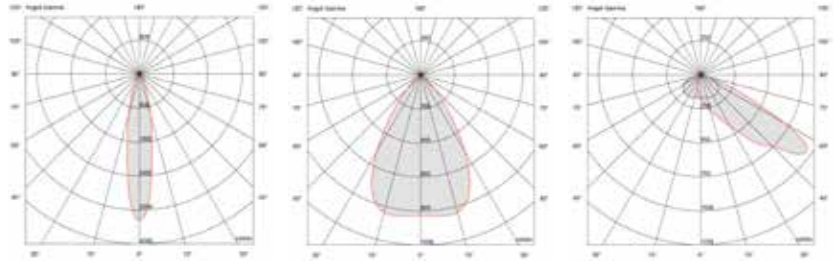

DATI TECNICI - TECHNICAL DATA



220-240 V AC



130/150 W

CRI

80



CL I



DIE-CAST ALUMINIUM



5 Kg

IP

65

PTR

VARIANTI - OPTIONS

ACCESSORI - ACCESSORIES

Cod.		Temperatura colore Color temperature	Flusso Luminoso Luminous flux	Apertura Fascio Beam angle	€
9717710064	130/150 W	4000K	15600/17400 lumen	65°	
9717620064	130/150 W	4000K	15600/17400 lumen	21°	
9716251264	130/150 W	4000K	15600/17400 lumen	120° x 70°	

Cod. SD4319
traversa testa palo 25 cm

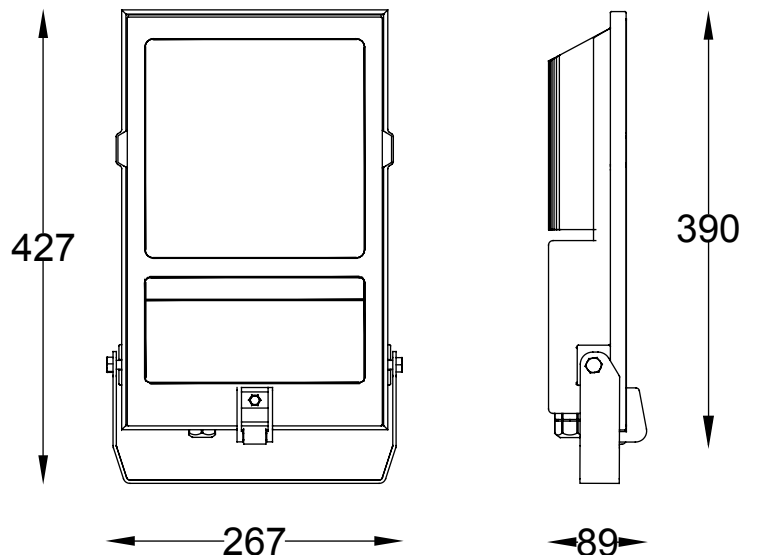

MIRA 80

IP
65



Apparecchio a 160 LED ad alta potenza, per l'illuminazione di esterni industriali con corpo in pressofusione di alluminio. Consigliato per sostituzione 250W Simmetrico. Protezione Termica Retroattiva (PTR).

160 LEDs high power fixture for outdoor industrial illumination, with die-cast aluminium body. suggested for replacement of symmetrical 250W discharged lamp. Thermal Retroactive Protection (PTR).

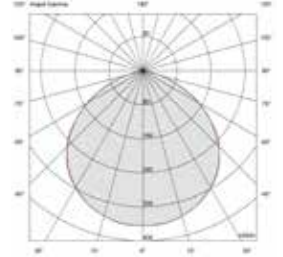

DATI TECNICI - TECHNICAL DATA



PTR

VARIANTI - OPTIONS

ACCESSORI - ACCESSORIES

Cod.	Temperatura colore Color temperature	Flusso Luminoso Luminous flux	€
9715561664	4000K	11800 lumen	

Cod. SD4319
traversa testa palo 25 cm

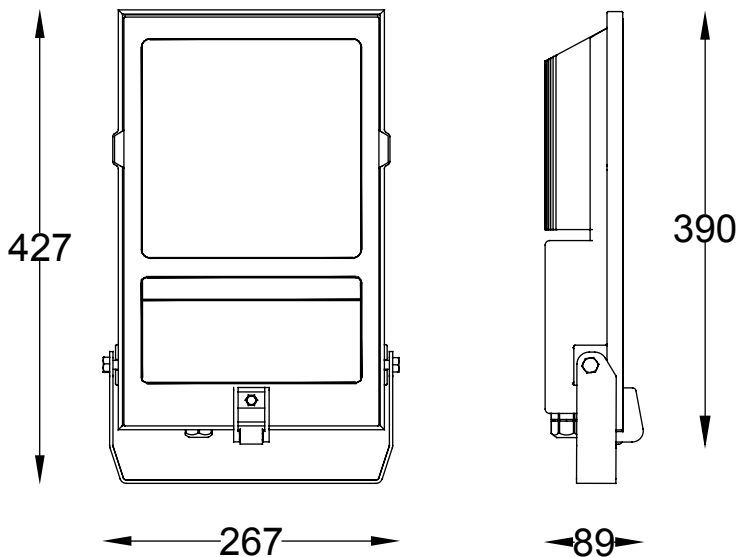

MIRA 80

IP 65



Apparecchio a 36 LED (9 led multichip) ad alta potenza, per l'illuminazione di esterni industriali con corpo in pressofusione di alluminio. Consigliato per sostituzione 250W fascio stretto. Protezione Termica Retroattiva (PTR).

36 LEDs (9 led multichip) high power fixture for outdoor industrial illumination, with die-cast aluminium body. suggested for replacement of narrow beam 250W discharged lamp. Thermal Retroactive Protection (PTR).

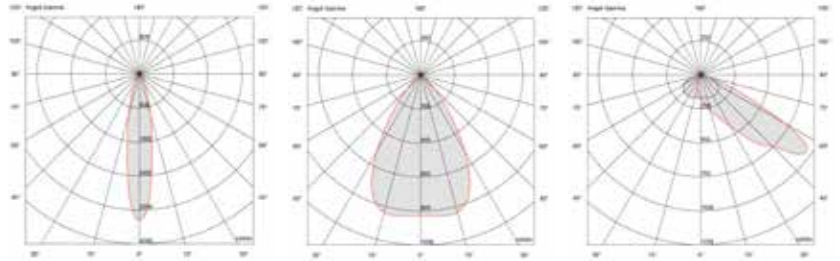

DATI TECNICI - TECHNICAL DATA



CRI
80



IP
65

PTR

VARIANTI - OPTIONS

ACCESSORI - ACCESSORIES

Cod.	Temperatura colore Color temperature	Flusso Luminoso Luminous flux	Apertura Fascio Beam angle	€
9715711264	4000K	9100 lumen	65°	
9715621264	4000K	9100 lumen	21°	
9715251264	4000K	9100 lumen	120° x 70°	

Cod. SD4319
traversa testa palo 25 cm

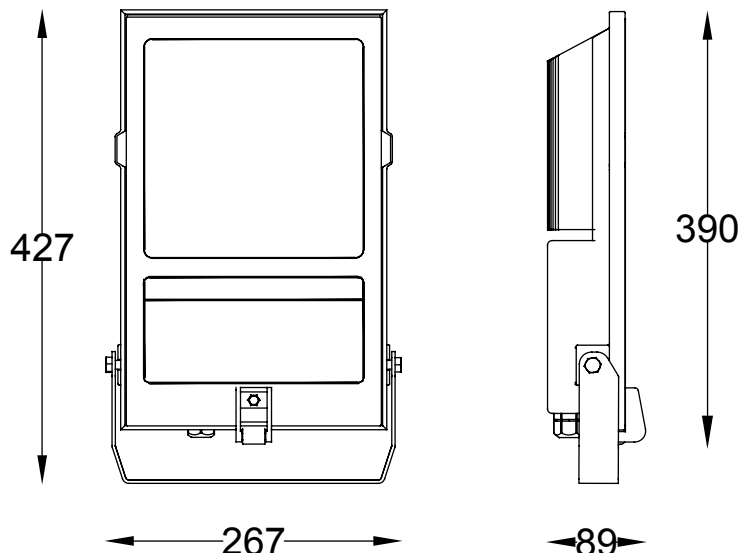

MIRA 50

IP
65



Apparecchio a 160 LED ad alta potenza, per l'illuminazione di esterni industriali con corpo in pressofusione di alluminio. Consigliato per sostituzione 150W Simmetrico. Protezione Termica Retroattiva (PTR).

160 LEDs high power fixture for outdoor industrial illumination, with die-cast aluminium body. suggested for replacement of symmetrical 150W discharged lamp. Thermal Retroactive Protection (PTR).

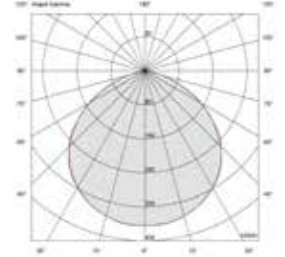

INDOOR

OUTDOOR

STRIP

STRADALE

INDUSTRIALE

DATI TECNICI - TECHNICAL DATA

		CRI				IP	PTR
220-240 V AC	52 W	80	CL I	DIE-CAST ALUMINIUM	3 Kg	65	

VARIANTI - OPTIONS

ACCESSORI - ACCESSORIES

Cod.	Temperatura colore Color temperature	Flusso Luminoso Luminous flux	€
9712561664	4000K	7950 lumen	

Cod. SD4319
traversa testa palo 25 cm

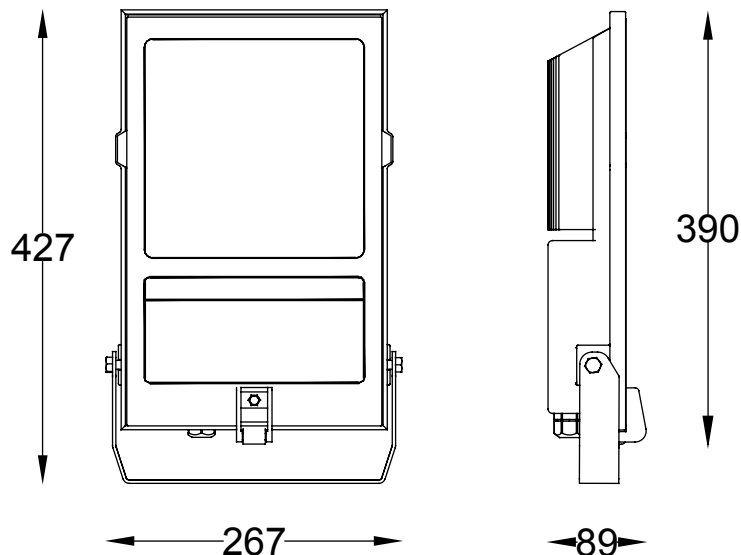





UFFICIO



PANEL T LED 60 X 60



Pannello a LED ad alta potenza a basso consumo ed alta efficienza, per interno, equivalente alla plafoniera ad incasso con 4 neon da 18W. Idoneo all'installazione in ambienti con video terminali.

Panel LED Indoor fixture, low consumption and high efficiency. The light output is similar to a 4x18W neon fitting. Suitable for installation in environments with video display terminals.

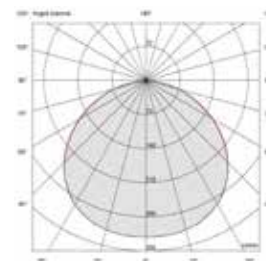

VARIANTI - OPTIONS

Cod.	Temperatura colore Color temperature	Flusso Luminoso Luminous flux	Apertura Fascio Beam angle	€
7711740364	4000K	3200 lumen	120°	

ACCESSORI - ACCESSORIES

Cod. 0047764 kit plafone

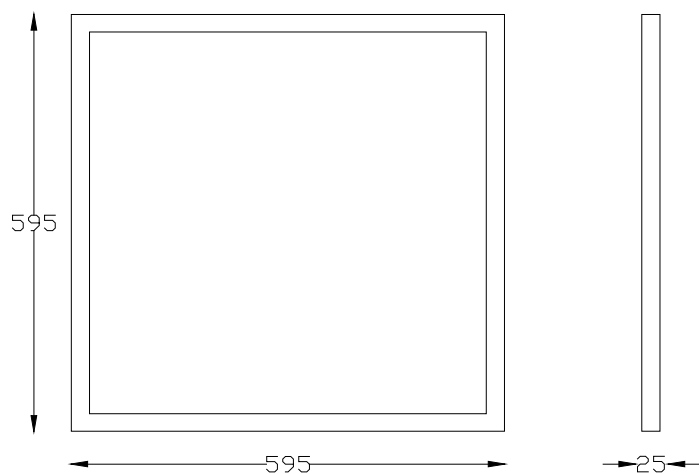

STAR 160

Lampada a 160 LED ad alta potenza a basso consumo ed alta efficienza, per incasso interno, equivalente ad un faro da 70W a scarica. Consumo massimo 32W.

Indoor recessed fitting with 160 high power LEDs, low consumption and high efficiency. The light output is similar to a 70 discharge lamp. Max power consumption 32W.

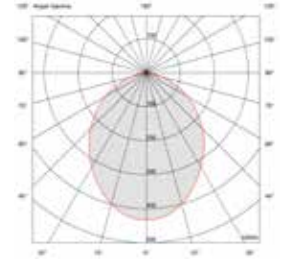

220-240 V AC



32 W

CRI

80



CL I



DIE-CAST ALUMINIUM



3Kg

IP

40



Ø 215

VARIANTI - OPTIONS

Cod.	Temperatura colore Color temperature	Flusso Luminoso Luminous flux	€
7709561264	4000K	4190 lumen	
7709561290	3000K	4070 lumen	

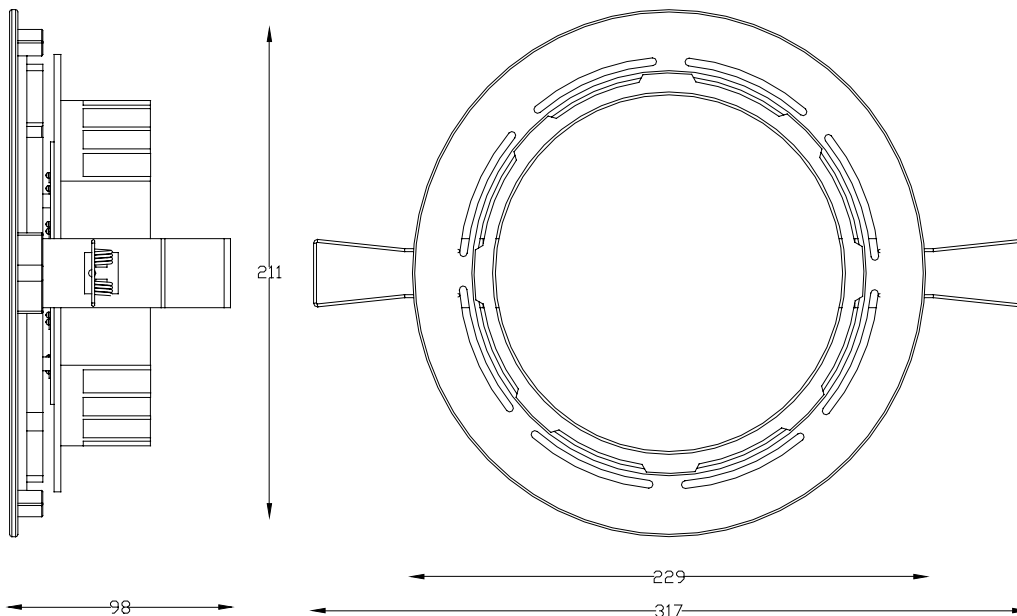

STAR 80



Lampada a 80 LED ad alta potenza a basso consumo ed ad alta efficienza, per incasso interno, equivalente ad un faro 2 X 26W.

Indoor recessed fitting with 80 high power LEDs, low consumption and high efficiency. The light output is similar to a 2x26W fitting.

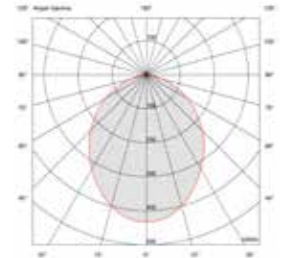

CRI
80



IP
40

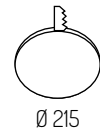

VARIANTI - OPTIONS

Cod.	Temperatura colore Color temperature	Flusso Luminoso Luminous flux	€
7708561264	4000K	2620 lumen	
7708561290	3000K	2540 lumen	

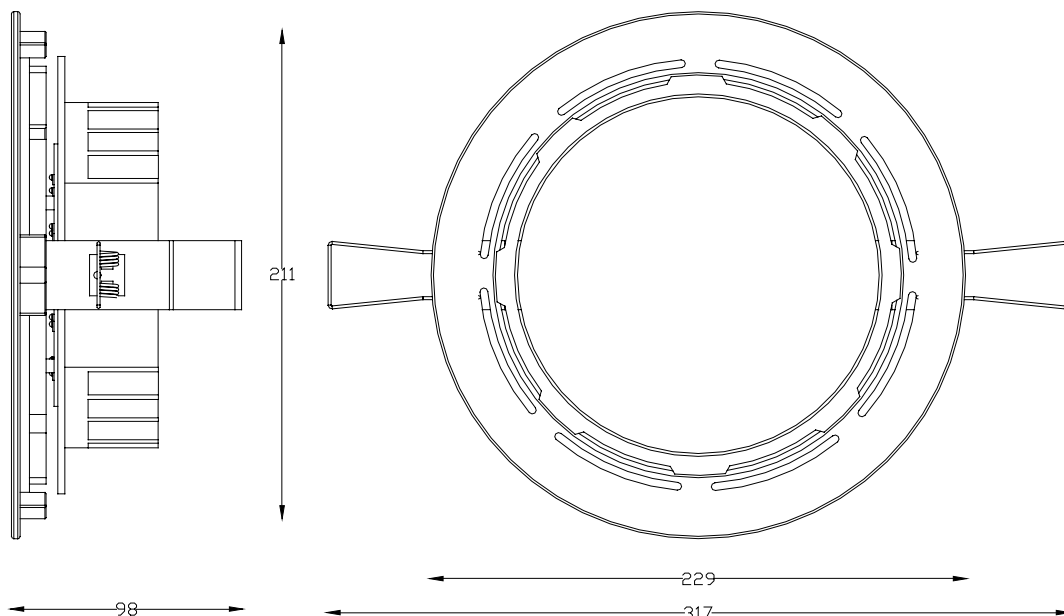

SERVIZI - SERVICES

UN PROGETTO ILLUMINOTECNICO SU MISURA

L'ufficio tecnico di Teclumen offre un servizio di progettazione avanzato per l'illuminazione professionale di interni ed esterni. Attraverso l'utilizzo del software DIALUX e con più di quarant'anni di esperienza nel settore della luce è in grado di fornire un supporto tecnico in grado di soddisfare le richieste più esigenti in qualsiasi ambito dell'illuminazione.

La nostra professionalità è frutto di competenze specifiche e di una filosofia lavorativa che pone il cliente al centro del progetto. Qualsiasi lavoro si sviluppa in maniera progressiva e parte dal concept luminoso, alla selezione delle tecnologie, per arrivare alla scelta finale dei prodotti.

Teclumen si pone l'obiettivo di illuminare in modo consapevole ed efficiente, con un occhio rivolto al risparmio energetico e alla valorizzazione dell'architettura che ci circonda.

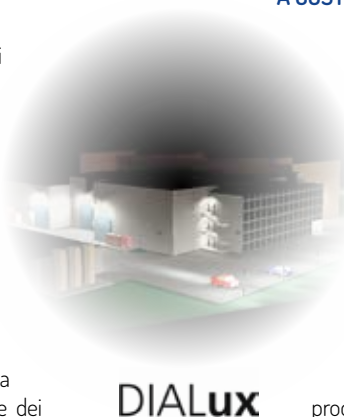

A CUSTOM TAILOR D LIGHTING PROJECT

Teclumen's technical office is offering a progressive planning service for professional indoor and outdoor lighting. Based on the use of the DIALUX software and more than 40 years of experience in the lighting sector we are able to offer a satisfactory technical assistance even for the most demanding requests for whatever lighting scope.

Our professionalism is a result of specific competences and a work philosophy which is putting our customer in the centre of the project. All the projects are evolving progressively starting with a lighting concept, choosing suitable technologies to end up with the selection of the products.

The target of Teclumen is to create a conscious and efficient lighting concept, keeping an eye on energy savings and the valorisation of the architecture which is surrounding us.

INDOOR

OUTDOOR

SITO WEB

Il sito di Teclumen è uno strumento a disposizione dei clienti dove è possibile trovare, in maniera semplice e veloce, informazioni tecniche e commerciali riguardanti i prodotti Teclumen.

La home page mette chiaramente in evidenza quali siano le aree a disposizione dell'utente:

PRODOTTI: area riservata ai prodotti da cui è possibile scaricare la scheda tecnica di ciascun articolo;

GALLERY: selezione delle foto relative alle applicazioni più rilevanti;

DOWNLOAD: sezione dedicata allo scaricamento di materiale tecnico e commerciale (cataloghi, listini, etc.);

REFERENZE: area dedicata a progetti realizzati contenente foto e lista dei prodotti installati;

CONTATTI: elenco dei contatti e dei riferimenti aziendali;

CUSTOMER SERVICE: portale dedicato ai clienti tramite il quale è possibile: scaricare fatture, aprire ticket di assistenza tecnica, comunicare direttamente con lo staff tecnico);

Per i **CLIENTI**, attraverso la casella di login, è inoltre possibile accedere all'**AREA RISERVATA** con la possibilità di:

- visualizzare i prezzi e le informazioni riservate di ogni prodotto;
- scaricare listini prezzi, curve fotometriche e schemi di funzionamento;

WEB PAGE

The Teclumen web page can be used as an instrument to easily and quickly find technical and sales information for all products.

The Teclumen home page is offering to the user an easy access to all the available areas.

PRODUCTS: reserved product area for the download of data sheets for every single item;

GALLERY: selection of photographs of most relevant applications;

DOWNLOAD: section dedicated to the download of technical and sales information (catalogues, price lists, etc.);

REFERENCES: area dedicated to projects details (photos and list of installed products);

CONTACTS: list of business contacts;

CUSTOMER SERVICE: customer portal dedicated to the download of invoices, to open technical service tickets or to directly contact our service staff;

It is also possible for **CUSTOMERS** to access the **RESERVED AREA** via the login box to:

- display prices and confidential information for every single product;
- download list prices, photometric data and manuals;

INDUSTRIALE

NORME ILLUMINOTECNICHE UNI EN 12464-1

N.rif	Tipo di attività	Em	UGR	Ra
1.1 ZONE DI CIRCOLAZIONE				
1.1.1	Aree di circolazione e corridoi	100	28	40
1.1.2	Scale, ascensori, tappeti mobili	150	25	40
1.1.3	Rampe e binari di carico	150	25	40
1.2 SALE DI RIPOSO, INFERMERIA E PRIMO SOCCORSO				
1.2.1	Mense	200	22	80
1.2.2	Locali di riposo	100	22	80
1.2.3	Locali per l'esercizio fisico	300	22	80
1.2.4	Guardaroba, gabinetti, bagni, toilette	200	25	80
1.2.5	Infermeria	500	19	80
1.2.6	Locali per visita medica	500	16	90
1.3 SALE DI COMANDO O DI CONTROLLO				
1.3.1	Locali impianti, sala interruttori	200	25	60
1.3.2	Locali fax, posta, quadri di controllo	500	19	80
1.4 MAGAZZINI / MAGAZZINI REFRIGERATI				
1.4.1	Magazzini, aree di stoccaggio	100	25	60
1.4.2	Aree di trasporto, imballaggio, spedizione	300	25	60
1.5 MAGAZZINI CON SCAFFALI				
1.5.1	Corridoi: senza personale	20	-	40
1.5.2	Corridoi: con presenza personale	150	22	60
1.5.3	Stazione di controllo	150	22	60
2.1 AGRICOLTURA				
2.1.1	Carico e gestione delle merci, uso di equipaggiamenti e macchine	200	25	80
2.1.2	Edifici per il bestiame	50	-	40
2.1.3	Aree per animali malati, celle parto	200	25	80
2.1.4	Preparazione mangime, caseifici, lavaggio utensili	200	25	80
2.2 FORNI, PANIFICI, PASTICCERIE				
2.2.1	Preparazione, cottura al forno	300	22	80
2.2.2	Finitura, glassatura, decorazione	500	22	80
2.3 CEMENTO, PRODOTTI IN CEMENTO, CALCESTRUZZO, MATTONI				
2.3.1	Asciugatura	50	28	20
2.3.2	Preparazione dei materiali, lavori al forno o ai miscelatori	200	28	40
2.3.3	Lavorazioni generiche alle macchine	300	25	80
2.3.4	Formature grossolane	300	25	80
2.4 CERAMICA, PIASTRELLE, VETRO, VETRERIE				
2.4.1	Asciugatura	50	28	20
2.4.2	Preparazione, lavorazioni generiche alle macchine	300	25	80
2.4.3	Smaltatura, laminatura, stampaggio, formatura di parti semplici, montaggio, soffiatura vetro	300	25	80
2.4.4	Molatura, incisione, brillantatura vetro, formatura di precisione, fabbricazione strumenti in vetro	750	19	80
2.4.5	Molatura vetro ottico, molatura manuale cristallo, incisione	750	16	80
2.4.6	Lavori di precisione ad esempio molatura decorativa, pittura a mano	1000	16	90
2.4.7	Lavorazione di pietre preziose sintetiche	1500	16	90
2.5 INDUSTRIA CHIMICA, DELLA PLASTICA E GOMMA				
2.5.1	Impianto di processo controllato a distanza	50	-	20
2.5.2	Impianto di processo con intervento manuale limitato	150	28	40
2.5.3	Luoghi di lavoro in installazioni di processo con presenza continua di personale	300	25	80
2.5.4	Ambienti per misure di precisione, laboratori	500	19	80
2.5.5	Produzione farmaceutica	500	22	80
2.5.6	Produzione pneumatici	500	22	80
2.5.7	Campionatura colori	1000	16	90
2.5.8	Taglio, finitura, ispezione	750	19	80
2.6 INDUSTRIA ELETTRICA				
2.6.1	Produzione conduttori	300	25	80
2.6.2	Avvolgimento:			
	- bobine di grandi dimensioni	300	25	80
	- bobine di medie dimensioni	500	22	80

N.rif	Tipo di attività	Em	UGR	Ra
	- bobine di piccole dimensioni	75	19	80
2.6.3	Impregnazione bobine	300	25	80
2.6.4	Galvanizzazione	300	25	80
2.6.5	Assemblaggio:			
	- grossolano (per esempio grandi trasformatori)	300	25	80
	- medio (per esempio quadri elettrici)	500	22	80
	- fine (per esempio telefoni)	750	19	80
	- di precisione (per esempio strumenti di misura)	1000	16	80
2.6.6	Produzione materiale elettronico, collaudo e aggiustaggio	1500	16	80
2.7 GENERI ALIMENTARI E INDUSTRIE ALIMENTARI DI LUSO				
2.7.1	Aree di lavoro in	200	25	80
	- fabbriche di birra, fermentazione del malto			
	- per lavaggio, riempimento barili, pulizia, setacciamento, sbucciatura			
	- cottura in fabbriche di conserve e cioccolato			
	- luoghi e aree di lavoro in zuccherifici			
	- fermentazione e asciugatura del tabacco, cantine di fermentazione			
2.7.2	Selezione e lavaggio prodotti, tritatura, miscelatura, confezionamento	300	25	80
2.7.3	Aree di lavoro e zone critiche in macelli, macellerie, caseifici, mulini, filtraggi in raffinerie dello zucchero	500	25	80
2.7.4	Taglio e selezione di vegetali e frutta	300	25	80
2.7.5	Produzione gastronomica, lavori di cucina, produzione sigari e sigarette	500	22	80
2.7.6	Ispezione di vetri e bottiglie, controllo prodotti, guarnitura, selezione, decorazione	500	22	80
2.7.7	Laboratori	500	19	80
2.7.8	Controllo colori	1000	16	90
2.8 FONDERIE				
2.8.1	Gallerie di manutenzione, cantine, ecc.	50	-	20
2.8.2	Piattaforme	100	25	40
2.8.3	Preparazione sabbie	200	25	80
2.8.4	Spogliatoi	200	25	80
2.8.5	Aree di lavoro al cubilotto e al miscelatore	200	25	80
2.8.6	Spazio di colata	200	25	80
2.8.7	Area di distaffatura	200	25	80
2.8.8	Modellazione a macchina	200	25	80
2.8.9	Modellazione manuale	300	25	80
2.8.10	Pressofusione	300	25	80
2.8.11	Reparto modelli	500	22	80
2.9 PARRUCCHIERI				
2.9.1	Parrucchieri	500	19	90
2.10 PRODUZIONE GIOIELLI				
2.10.1	Lavorazione delle pietre preziose	1500	16	90
2.10.2	Produzione gioielli	1000	16	90
2.10.3	Costruzione orologi (manuale)	1500	16	80
2.11 LAVANDERIE E TINTORIE				
2.11.1	Raccolta capi, marcatura e smistamento	300	25	80
2.11.2	Lavaggio e pulizia a secco	300	25	80
2.11.3	Stiratura, stiratura a vapore	300	25	80
2.11.4	Ispezione e riparazione	750	19	80
2.12 PELLE E CAPI IN PELLE				
2.12.1	Lavori in tino, vasca, fossa	200	25	40
2.12.2	Scamatura, smussatura, tamponatura, bollatura delle pelli	300	25	80
2.12.3	Lavori di selleria, manifattura scarpe: cucitura, lucidatura, formatura, taglio, foratura	500	22	80
2.12.4	Selezione	500	22	90
2.12.5	Tintura del cuoio (a macchina)	500	22	80
2.12.6	Controllo qualità	1000	19	80
2.12.7	Campionatura colori	1000	16	90

INDOOR

OUTDOOR

INDUSTRIAL

N.rif	Tipo di attività	Em	UGR	Ra
2.12.8	Produzione scarpe	500	22	80
2.12.9	Produzione guanti	500	22	80
2.13 LAVORAZIONE E TRASFORMAZIONE DEI METALLI				
2.13.1	Fucinatura libera	200	25	60
2.13.2	Fucinatura a stampo	300	25	60
2.13.3	Saldatura	300	25	60
2.13.4	Lavorazione grossolana o media: tolleranza ≥ 0,1 mm	300	22	60
2.13.5	Lavorazione fine: tolleranza < 0,1 mm	500	19	60
2.13.6	Tracciatura, ispezione	750	19	60
2.13.7	Laboratorio trafilatura, costruzione tubi, formatura a freddo	300	25	60
2.13.8	Lavorazione laminati: spessore ≥ 5 mm	200	25	60
2.13.9	Lavorazione fogli: spessore < 5 mm	300	22	60
2.13.10	Fabbricazione utensili e attrezzi da taglio	750	19	60
2.13.11	Assemblaggio:			
	- grossolano	200	25	80
	- medio	300	25	80
	- fine	500	22	80
	- di precisione	750	19	80
2.13.12	Galvanizzazione	300	25	80
2.13.13	Preparazione superfici e verniciatura	750	25	80
2.13.14	Attrezzi, preparazione sagome e calibri, meccanica di precisione, micromeccanica	1000	19	80
2.14 CARTA E OGGETTI DI CARTA				
2.14.1	Preparazione dell'impasto e raffinazione	200	25	80
2.14.2	Fabbricazione e trasformazione della carta, macchine per carta e cartone ondulato, fabbricazione del cartone	300	25	80
2.14.3	Lavori di rilegatura per esempio: piegatura, smistamento, incollaggio, taglio stampa, cucitura	500	22	80
2.15 CENTRALI ELETTRICHE				
2.15.1	Impianto alimentazione combustibile	50	-	20
2.15.2	Locale caldaie	100	28	40
2.15.3	Sala turbine	200	25	80
2.15.4	Locali annessi per esempio: locali pompe, locali condensatori, quadri di controllo interni	200	25	60
2.15.5	Sala di controllo	500	16	80
2.15.6	Dispositivi di controllo esterno	20	-	20
2.16 STAMPERIE				
2.16.1	Taglio, doratura, stampa in rilievo, lavori su pietra, macchine da stampa, costruzione matrici	500	19	80
2.16.2	Selezione fogli e stampa a mano	500	19	80
2.16.3	Montaggio caratteri, ritocco, litografia	1000	19	80
2.16.4	Controllo colori in stampe policrome	1500	16	90
2.16.5	Incisione su acciaio e rame	2000	16	80
2.17 LAMINATOI, LAVORAZIONI FERRO E ACCIAIO				
2.17.1	Impianti di produzione senza intervento manuale	50	-	20
2.17.2	Impianti di produzione con intervento manuale occasionale	150	28	40
2.17.3	Impianti di produzione con intervento manuale continuo	200	25	80
2.17.4	Magazzino laminati	50	-	20
2.17.5	Fornace	200	25	20
2.17.6	Treno di laminazione, avvolgitori, linea di taglio	300	25	40
2.17.7	Piattaforma di controllo, quadri di controllo	300	22	80
2.17.8	Prova, misura e controllo	500	22	80
2.17.9	Gallerie di manutenzione, sezione cinghie, cantine ecc.	50	-	20
2.18 LAVORAZIONE E MANIFATTURA TESSILE				
2.18.1	Aree di lavoro a lato delle vasche di lavaggio, apertura balle	200	25	60
2.18.2	Cardatura, lavaggio, stiratura, disegno, pettinatura, imbozzimatura, incollaggio, punzonatura cartoni, profilatura, filatura juta e canapa	300	22	80
2.18.3	Filatura, ritorcinatura, aspatura, sbobinatura	500	22	80
2.18.4	Ordinatura, tessitura, intrecciatura, maglieria	500	22	80
2.18.5	Cucitura, maglieria fine, rimagliatura, rammendo	750	22	80
2.18.6	Disegno manuale, disegno trame	750	22	90
2.18.7	Finitura, tintura	500	22	80
2.18.8	Camera di asciugatura	100	28	60
2.18.9	Stampaggio automatico	500	25	80

N.rif	Tipo di attività	Em	UGR	Ra
2.18.10	Annodatura, ispezione della trama, passamaneria	1000	19	80
2.18.11	Ispezione colori, controllo fabbricazione	1000	16	90
2.18.12	Rammendo invisibile	1500	19	90
2.18.13	Manifattura cappelli	500	22	80
2.19 COSTRUZIONE VEICOLI				
2.19.1	Carrozzeria e assemblaggio	500	22	80
2.19.2	Verniciatura, spruzzatura, lucidatura	750	22	80
2.19.3	Verniciatura: ritocco, ispezione	1000	19	90
2.19.4	Produzione rivestimenti interni (locali occupati)	1000	19	80
2.19.5	Ispezione finale	1000	19	80
2.20 LAVORAZIONE E MANIFATTURA LEGNO				
2.20.1	Processi automatici, ad esempio: essiccazione, produzione compensato	50	28	40
2.20.2	Camere del vapore	150	28	40
2.20.3	Sega	300	25	60
2.20.4	Lavori al banco di falegnameria, incollaggio, assemblaggio	300	25	80
2.20.5	Lucidatura, verniciatura, falegnameria di fantasia	750	22	80
2.20.6	Lavorazioni su macchine utensili, per esempio: tornitura, scannellatura, sgrossatura, ribassatura, scanalatura, taglio, segatura, cavatura	500	19	80
2.20.7	Selezione legno per impiallacciatura	750	22	90
2.20.8	Intarsio, lavoro d'intarsio	750	22	90
2.20.9	Controllo qualità, ispezione	1000	19	90
3 UFFICI				
3.1	Archiviazione, copiatura	300	19	80
3.2	Scrittura, dattilografia, lettura, elaborazione dati	500	19	80
3.3	Disegno tecnico	750	16	90
3.4	Postazioni CAD	500	19	80
3.5	Sale conferenze e riunioni	500	19	80
3.6	Ricezione (reception)	300	22	80
3.7	Archivi	200	25	80
4 VENDITA AL DETTAGLIO				
4.1	Aree di vendita	300	22	80
4.2	Casse	500	19	80
4.3	Tavolo imballaggio	5000	19	80
5.1 SPAZI COMUNI				
5.1.1	Ingressi	100	22	80
5.1.2	Guardaroba	200	25	80
5.1.3	Sale attese	200	22	80
5.1.4	Biglietteria	300	22	80
5.2 RISTORANTI E HOTEL				
5.2.1	Reception/cassa, portineria	300	22	80
5.2.2	Cucina	500	22	80
5.2.3	Ristorante, sala da pranzo, sala ricevimenti	-	-	80
5.2.4	Ristoranti self-service	200	22	80
5.2.5	Buffet	300	22	80
5.2.6	Sale conferenze	500	19	80
5.2.7	Corridoi	100	25	80
5.3 TEATRI, SALE DA CONCERTO, CINEMA				
5.3.1	Sale di prova, spogliatoi	300	22	80
5.4 FIERE, PADIGLIONI ESPOSITIVI				
5.4.1	Illuminazione generale	300	22	80
5.5 MUSEI				
5.5.1	Oggetti esposti insensibili alla luce	-	-	-
5.5.2	Oggetti esposti sensibili alla luce	-	-	-
5.6 LIBRERIE				
5.6.1	Scaffali	200	19	80
5.6.2	Area di lettura	500	19	80
5.6.3	Posti di servizio al pubblico	500	19	80
5.7 PARCHEGGI PUBBLICI (COPERTI)				
5.7.1	Rampe di ingresso / uscita (durante il giorno)	300	25	20
5.7.2	Rampe di ingresso / uscita (durante la notte)	75	25	20
5.7.3	Corsie di circolazione	75	25	20
5.7.4	Aree di parcheggio	75	-	20
5.7.5	Biglietteria	300	19	80
6.1 ASILI NIDO, SCUOLE MATERNE				

N.rif	Tipo di attività	Em	UGR	Ra
6.1.1	Aule giochi	300	19	80
6.1.2	Nido	300	19	80
6.1.3	Aule per lavoro manuale	300	19	80
6.2 EDIFICI SCOLASTICI				
6.2.1	Aule scolastiche	300	19	80
6.2.2	Aule in scuole serali per adulti	500	19	80
6.2.3	Sale lettura	500	19	80
6.2.4	Lavagna	500	19	80
6.2.5	Tavolo per dimostrazioni	500	19	80
6.2.6	Aule educazione artistica	500	19	80
6.2.7	Aule educazione artistica in scuole d'arte	750	19	80
6.2.8	Aule per disegno tecnico	750	16	80
6.2.9	Aule per educazione tecnica e laboratori	500	19	80
6.2.10	Aule lavori artigianali	500	19	80
6.2.11	Laboratorio insegnamento	500	19	80
6.2.12	Aule musica	300	19	80
6.2.13	Laboratori di informatica	300	19	80
6.2.14	Laboratori linguistici	300	19	80
6.2.15	Aule di preparazione e officine	500	22	80
6.2.16	Ingressi	200	22	80
6.2.17	Aree di circolazione , corridoi	100	25	80
6.2.18	Scale	150	25	80
6.2.19	Sale comuni per gli studenti e aula magna	200	22	80
6.2.20	Sale professori	300	19	80
6.2.21	Biblioteca: scaffali	200	19	80
6.2.22	Biblioteca: aree di lettura	500	19	80
6.2.23	Magazzini materiale didattico	100	25	80
6.2.24	Palazzetti, palestre, piscine (uso generale)	300	22	80
6.2.25	Mensa	200	22	80
6.2.26	Cucina	500	22	80
7.1 LOCALI DI USO GENERALE				
7.1.1	Sale attesa	200	22	80
7.1.2	Corridoi: durante il giorno	200	22	80
7.1.3	Corridoi: durante la notte	50	22	80
7.1.4	Day room	200	22	80
7.2 LOCALI PER IL PERSONALE				
7.2.1	Ufficio personale	500	19	80
7.2.2	Stanza personale	300	19	80
7.3 CORSIE, REPARTI MATERNITA'				
7.3.1	Illuminazione generale	100	19	80
7.3.2	Illuminazione di lettura	300	19	80
7.3.3	Visita semplice	300	19	80
7.3.4	Visita e trattamento	1000	19	80
7.3.5	Luce notturna, luce di sorveglianza	5	-	80
7.3.6	Bagni, toilette per pazienti	200	22	80
7.4 LOCALI DIAGNOSTICI				
7.4.1	Illuminazione generale	500	19	90
7.4.2	Visita e trattamento	1000	19	90
7.5 LOCALI PER VISITE OCULISTICHE				
7.5.1	Illuminazione generale	300	19	90
7.5.2	Visita esterna dell'occhio	1000	-	90
7.5.3	Test di lettura e visione dei colori sui pannelli	500	16	90
7.6 LOCALI PER VISITE OTORINOLARINGOIATRICHE				
7.6.1	Illuminazione generale	300	19	80
7.6.2	Visita orecchio	1000	-	90
7.7 LOCALE ANALISI				
7.7.1	Illuminazione generale	300	19	80
7.7.2	Analisi con amplificatore di immagini e sistemi televisivi	50	19	80
7.8 SALE PARTO				
7.8.1	Illuminazione generale	300	19	80
7.8.2	Visita e trattamento	1000	19	80
7.9 LOCALI DI CURA				
7.9.1	Dialisi	500	19	80
7.9.2	Dermatologia	500	19	80
7.9.3	Endoscopia	300	19	80

N.rif	Tipo di attività	Em	UGR	Ra
7.9.4	Ingessatura	500	19	80
7.9.5	Bagni medicali	300	19	80
7.9.6	Massaggio e radioterapia	300	19	80
7.10 SALE OPERATORIE				
7.10.1	Locale pre-operatorio e risveglio	500	19	90
7.10.2	Sala operatoria	1000	19	90
7.10.3	Area operatoria			
7.11 RIANIMAZIONE E CURE INTENSIVE				
7.11.1	Illuminazione generale	100	19	90
7.11.2	Visita semplice	300	19	90
7.11.3	Visita e trattamento	1000	19	90
7.11.4	Ingessatura	20	19	90
7.12 ODONTOIATRIA				
7.12.1	Illuminazione generale	500	19	90
7.12.2	Sul paziente	1000	-	90
7.12.3	Area operatoria	5000	-	90
7.12.4	Confronto con il colore dei denti	5000	-	90
7.13 LABORATORI E FARMACIE				
7.13.1	Illuminazione generale	500	19	80
7.13.2	Ispezione colori	1000	19	90
7.14 LOCALI DI DECONTAMINAZIONE				
7.14.1	Locali di sterilizzazione	300	22	80
7.14.2	Locali disinfestazione	300	22	90
7.15 LOCALI PER AUTOPSIA E CAMERA MORTUARIA				
7.15.1	Illuminazione generale	500	19	90
7.15.2	Tavolo per autopsia e dissezione	5000	-	90
8.1 AEROPORTI				
8.1.1	Sale di arrivo e partenza, aree ritiro bagagli	200	22	80
8.1.2	Aree di collegamento, scale e tappeti mobili	150	22	80
8.1.3	Banchi informazioni, accettazione	500	19	80
8.1.4	Dogana e controllo passaporti	500	19	80
8.1.5	Sale attesa	200	22	80
8.1.6	Deposito bagagli	200	25	80
8.1.7	Aree controllo di sicurezza	300	19	80
8.1.8	Torre di controllo traffico aereo	500	16	80
8.1.9	Hangar per le riparazioni ed i controlli	500	22	80
8.1.10	Aree controllo motori	500	22	80
8.1.11	Aree di misura all'interno degli hangar	500	22	80
8.2 STAZIONI				
8.2.1	Banchine e sottopassaggi passeggeri	100	28	40
8.2.2	Atrii e sportelli	200	28	40
8.2.3	Biglietteria, deposito bagagli, cassa	300	19	80
8.2.4	Sale attesa	200	22	80



ILLUMINOTECNICA - LIGHTING ENGINEERING

La luce

Il ristrettissimo campo delle radiazioni elettromagnetiche la cui lunghezza d'onda è compresa tra $\lambda = 380\text{nm}$ e $\lambda = 780\text{nm}$ costituisce lo spettro luminoso visibile. L'occhio umano non è ugualmente sensibile alle varie radiazioni. Curva di sensibilità relativa all'occhio in funzione della lunghezza d'onda:

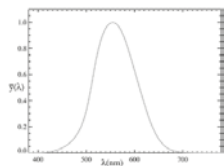

Indice di resa dei colori Ra

È un parametro che esprime l'attitudine che la sorgente ha nel rendere i colori degli oggetti. Per valutare la qualità di resa cromatica di una sorgente luminosa si ricorre al metodo CIE1965. Esso consiste nel "misurare" come il colore di un certo numero di piastrelle campione varia passando dalla sorgente in prova a una di riferimento (sorgente campione). Le proprietà di resa cromatica sono espresse mediante un indice generale di Resa cromatica "Ra" il cui valore massimo è pari a 100.

Tonalità della luce

I parametri resa del colore e tonalità di luce sono essenziali per valutare l'aspetto qualitativo della luce emessa da una sorgente luminosa. La tonalità della luce emessa da una lampada è caratterizzata dalla temperatura di colore, espressa in gradi Kelvin (K). Vengono definite a tonalità calda le lampade con temperatura di colore compresa tra 2000 e 3300K consigliata negli ambienti residenziali e in generale quando il livello d'illuminamento è inferiore ai 300lux, a tonalità naturale le lampade con temperatura di colore compresa tra 3300 e 5300K indicata per la generalità degli ambienti di lavoro, a tonalità fredda le lampade con temperatura di colore superiore a 5300K impiegata per livelli d'illuminamento elevati.

Grandezze fotometriche fondamentali e loro unità di misura

- **Flusso luminoso (F):** è la potenza irradiata complessivamente da una sorgente luminosa e percepita dall'occhio umano. [Lumen - lm].
- **Efficienza luminosa o rendimento (hL):** è il rapporto tra il flusso luminoso e la potenza elettrica assorbita [lm/w].
- **Intensità luminosa (I):** densità di flusso luminoso in una determinata direzione [Candela - cd].
- **Illuminamento o chiarezza (E):** quantità di luce proveniente da una sorgente luminosa che colpisce una superficie S posta ad una distanza h (metri) [Lux - lx]. $E = f/S = I/h^2$
- **Luminanza (L):** esprime l'effetto di luminosità che una certa superficie produce sull'occhio [Candela per m² - cd/m²].

Uniformità d'illuminamento

L'adeguato illuminamento in un compito visivo viene garantito oltre che dal suo livello, dalla sua uniformità: nell'ambito del compito visivo, la distribuzione degli illuminamenti deve essere tale che il rapporto fra il valore minimo e il valore medio non risulti inferiore a 0,8. Nel caso d'illuminazione generale orientata sul posto di lavoro l'illuminamento nelle zone di transito non dev'essere inferiore ad un terzo dell'illuminamento medio delle zone di lavoro.

Curva fotometrica

Il solido fotometrico è l'insieme delle misure delle intensità luminose emesse da un apparecchio in ogni direzione. Solitamente non vengono fornite tutte le informazioni riguardanti il solido fotometrico ma solo quelle riferite ai piani trasversale e longitudinale che passano per il centro dell'ottica dell'apparecchio. I valori rilevati sperimentalmente sono generalmente riferiti ad un flusso di 1000 lumen e sono rappresentati in coordinate polari oppure coordinate cartesiane.

Coefficiente di manutenzione (km)

Tiene conto di quei parametri che possono incidere sul valore d'illuminamento come ad esempio fumi o polveri in sospensione o depositati sull'apparecchio, oppure il naturale calo dell'emissione luminosa delle lampade per invecchiamento. Il suo valore è generalmente considerato 0,8.

Light

The very narrow range of electromagnetic radiations, whose wave-length varies between $\lambda = 380\text{nm}$ and $\lambda = 780\text{nm}$, represents the visible spectrum. Human eyes are not equally sensitive to the various radiations. Sensitivity curve of eyes in accordance to the wave-length:

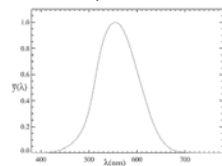

Colour yield index Ra

It is a parameter which expresses the turn the source has in rendering the colours of objects. Appraisal of chromatic yield quality of a luminous source is made in accordance to method CIE1965. It consists of measuring how the colour of a given quantity of plaques changes, passing from a testing source to a reference source (sample source).

Properties of chromatic yield are expressed through a general index of colour yield "Ra", whose maximum value is 100.

Tonality of light

Parameters of colour yield and light tonality are essential to appraise the quality level of the light coming from a luminous source.

The tonality of light emitted by a lamp is characterized by temperature of colour, expressed in degrees Kelvin (K).

By "warm tonality" we define the temperatures of colour ranging between 2000 and 3300K, suitable for residential environments and, in general, whenever the level of illumination is below 300lux; by "natural tonality" we define lamps with temperature of colour between 3300 and 5300K, mostly suitable for working areas; by "cold tonality" we define temperatures exceeding 5300K, suitable for high levels of illumination.

Main photometric measures and their unit of measure

- **Luminous flux (F):** It is the total power irradiated by a luminous source and perceived by the human eye [Lumen - lm].
- **Luminous efficiency or performance (hL):** It is the ratio between the luminous flux and the absorbed electrical power [lm/w].
- **Luminous intensity (I):** Density of luminous flux in a given direction [Candles - cd].
- **Illumination or clarity (E):** Quantity of light coming from a luminous source, hitting a surface S at a distance h (metres) [Lux - lx]. $E = f/S = I/h^2$
- **Luminance (L):** It expresses the luminous effect that a certain surface produces on the eye [Candles per m² - cd/m²].

Uniformity of illumination

The suitable illumination in a visible task is guaranteed by either its level or its uniformity: in the field of visible task, distribution of illumination must be such as the ration between minimum and average value is not below 0,8. In the case of general illumination directed to the working position, illumination in the transit areas must not be below 1/3 of the average illumination in the working positions.

Photometric curve

The photometric solid is the whole of luminous intensity measures emitted by an apparatus in each and every direction. Not all the information regarding photometric solid are usually given, but only those regarding transversal and longitudinal planes, passing through the centre of the optics.

The values surveyed experimentally are generally referred to a flux of 1000 lumen and are represented in polar or cartesian coordinates.

Maintenance coefficient (km)

It takes into account all the parameters which may influence the value of illumination, such as smoke, suspended or deposited dust, or the natural loss of luminous emission caused by ageing. Its value is generally considered to be 0,8.

GRADO DI PROTEZIONE IP - PROTECTION DEGREE IP

1^a cifra, 1st figure

2

Protetto contro i corpi solidi superiori a 12 mm (contatti involontari della mano).

Solid bodies-proof bigger than 12 mm (unintentional contacts of the hand).

3

Protetto contro i corpi solidi superiori a 2.5 mm (utensili, fili). Solid bodies-proof bigger than 2.5 mm (tools, threads).

4

Protetto contro i 4 corpi solidi ≥ 1 mm (utensili fini, piccoli fili).

Solid bodies-proof ≥ 1 mm (thin tools, thin threads).

5

Protetto contro le polveri.

Powders-resistant.

6

Totalmente protetto contro le polveri.

Fully powders-resistant.

2^a cifra, 1st figure

1

Protetto contro lo stillicidio (condensa).

Protected against water drops.

3

Protetto contro la pioggia fino a 60° dall'asse verticale.

Protected against rain up to 60° from vertical axis.

4

Protetto gli spruzzi d'acqua da tutte le direzioni (360°).

Protected against water projections from everywhere (360°).

5

Protetto contro i getti d'acqua da tutte le direzioni da lancia d'irrigazione pressione 0,3bar a 3m (12.5l/min).

Protected against water spouts from everywhere pression-test of 0.3 bar at 3m (12.5l/min).

6

Protetto contro i getti d'acqua da tutte le direzioni da lancia d'irrigazione pressione 1bar a 3m (100l/min).

Protected against water spouts from everywhere pression-test of 1bar at 3m (100l/min).

7

Protetto contro gli effetti dell'immersione (≤ 1 m).

Protected against immersion effects (≤ 1 m).

8

Materiale sommergibile (>1 m). Protetto contro gli effetti prolungati dell'immersione sotto pressione.

Submarine material (>1 m). Protected against prolonged effects of immersion under pression.

3^a cifra, 1st figure

1

Protetto contro un urto di energia 0,025j.

Protected against shocks of 0,025j.

3

Protetto contro un urto di energia 0,5j.

Protected against shocks of 0,5j.

5

Protetto contro un urto di energia 2j.

Protected against shocks of 2j.

7

Protetto contro un urto di energia 6j.

Protected against shocks of 6j.

9

Protetto contro un urto di energia 20j.

Protected against shocks of 20j.

INDOOR

OUTDOOR

INDUSTRIAL

CONDIZIONI GENERALI DI VENDITA

ART. 1 GENERALITÀ

Le presenti condizioni di vendita, che annullano e sostituiscono le precedenti, sono applicabili a tutte gli ordini da noi evasi e si intendono integralmente accettati dal compratore con il conferimento dell'ordine, sia scritto, che verbale. Il ritiro della merce costituisce conferma d'ordine implicita.

ART. 2 PRODOTTI

I prodotti sono illustrati in appositi cataloghi e listini. Piccole variazioni nella produzione e presentazione del prodotto, che non ne modificano le caratteristiche d'uso, possono essere apportate dalla nostra Società senza preavviso e non possono essere invocate dal compratore come cause per annullamento dell'ordine.

ART. 3 PREZZI

Non verrà dato seguito ad ordini inferiori a € 100,00 (inteso come netto merce).

Tutti i prezzi indicati nei nostri listini sono da intendersi "Franco Casaloldo (MN) Italia", IVA esclusa.

Sconti: sono proporzionali ai quantitativi ordinati annualmente o per ordine. Per importi inferiori a € 150,00 la vendita verrà effettuata senza sconti. Per importi inferiori a € 200,00 il pagamento sarà anticipato o in contrassegno.

ART. 4 IMBALLI

Per l'imballaggio standard verrà addebitato un costo pari al 2% dell'imponibile merce.

ART. 5 TRASPORTI

Nei casi in cui il mezzo di spedizione non sia esplicitamente indicato dal cliente, la spedizione verrà effettuata nel modo da noi ritenuto più idoneo ed il compratore non potrà rifiutare il pagamento del costo del trasporto. La merce viaggia a rischio e pericolo del committente, anche se spedita in porto franco. L'Assicurazione viene coperta solo su richiesta specifica dell'acquirente ed è a suo carico.

ART. 6 CONSEGNE

I termini di consegna non sono impegnativi, ma solo indicativi. L'acquirente esonera il venditore da ogni e qualsiasi responsabilità per danni conseguenti a ritardi nella consegna delle merci. Il ritardo di consegna per pezzi speciali appositamente prodotti non può essere causa di annullamento dell'ordine.

ART. 7 GARANZIA

I nostri prodotti sono garantiti per difetti di materiale, o di lavorazione a noi imputabili, per un periodo di 12 mesi dalla data di consegna. La garanzia decade qualora:

- a) il prodotto sia stato usato al di fuori delle condizioni di esercizio da noi indicate;
- b) il materiale sia stato comunque modificato o manipolato da persona non autorizzata dalla nostra Società.

La garanzia si limita alla riparazione o sostituzione dei prodotti difettosi con l'assoluta esclusione di qualsiasi responsabilità derivante da danni comunque causati dall'uso dei nostri prodotti.

N.B.: In caso di riparazione o sostituzione presso il nostro stabilimento la merce viaggerà a carico del cliente.

ART. 8 RECLAMI

Eventuali reclami devono essere effettuati entro 8 giorni dalla data di consegna della merce.

ART. 9 RESI

Ogni reso dovrà essere preventivamente autorizzato dall'ufficio commerciale che ha effettuato la vendita tramite la compilazione di opportuno modulo RMA. Al reso verrà assegnato un numero identificativo che dovrà essere tassativamente allegato alla merce in rientro. Non si darà luogo al ritiro di resi privi del numero di identificazione. Ogni reso dovrà essere effettuato in porto franco.

ART. 10 PAGAMENTI

I pagamenti devono essere effettuati a Teclumen s.r.l. Non si accettano sconti ed arrotondamenti. Il costo dei bolli tratta sarà anticipato da Teclumen s.r.l. e riaddebitato in fattura per il puro costo sostenuto. Tale importo è esente da I.V.A. ai sensi dell'art. 15/3 del D.P.R. 633/72.

Eventuali ritardi di pagamento saranno gravati di interessi pari al 1,5% mensile oltre alle spese bancarie ed eventuali spese legali.

ART. 11 RISERVATO DOMINIO

La merce resta di proprietà della venditrice Teclumen s.r.l. fino al completo pagamento della stessa, nonché delle somme dovute per trasporto, assicurazione, ecc.

ART. 12 RECESSIONE DAL CONTRATTO

Nel caso in cui il Cliente annulli interamente o parzialmente l'ordinazione per qualsiasi motivo, sarà tenuto a versare il 20%

ART. 13 CONTESTAZIONI

Per qualsiasi controversia il foro competente è il foro di Mantova.

ART. 14 SPECIFICHE

I dati presenti in questo documento possono subire variazioni senza preavviso ai fini di migliorare il prodotto o di correggere eventuali errori.

SALES TERMS AND GENERAL CONDITIONS

ART. 1 PREAMBLE

Prices are intended EX-WORKS our plant in Casaloldo (MN), Italy. VAT and taxes are not included.

Teclumen reserves the right to make price variations and technical modifications without prior notice.

ART. 2 GOODS AND PACKING

The goods are securely packed with the latest packing methods. For this reason Teclumen invoices a packing fee of 2 % on the total order amount.

ART. 3 LAMPS AS A PART OF THE ORDER

The projectors include the lamp, where this is indicated on the pricelist.

ART. 4 TRANSPORT LIABILITY

The goods travel at the risk of the consignee (also in case of C&F), therefore it is in the buyer's interest to check the state of the equipment on arrival. In case of damages or loss, claims must be addressed directly to the forwarder.

ART. 5 SHIPPING DAMAGE LIABILITY

Teclumen accepts only claims regarding the goods within 8 days from the receipt of the goods.

ART. 6 RETURN OF GOODS

Return of equipment will not be accepted without the prior authorization of Teclumen. The goods must be securely packed and returned in its original package. All returns must be accompanied by the relevant shipping documents indicating: Teclumen's authorization, the invoice number and date and reason of return.

The freight costs for returns (also for goods under warranty) are always at the charge of the buyer.

ART. 7 AVAILABILITY DELAY

Teclumen will try to respect as much as possible the agreed terms of delivery. Nevertheless Teclumen does not accept any responsibility for delay in delivery.

ART. 8 WARRANTY

The Teclumen projectors are covered by 24 months warranty. The warranty is only valid if the equipment has been correctly used. The warranty does not cover breakdown or damages caused by tampering, accidents, negligence or incorrect use of the equipment.

ART. 9 WARRANTY LIMITATION

The warranty excludes lamps, mirrors, belts, wear-and-tear components.

ART. 10 OVERDUE PAYMENTS

Delays in payment, unauthorized discount or rounding off of the due amount are not permitted. In case of delay of payment, Teclumen is authorized to charge bank interests, at current interests, as well as all the charges to get outstanding credits.

The non-respect of terms of payment will cancel all obligations on behalf of Teclumen and all consignments will be suspended.

ART. 11 COURT OF JURISDICTION

In case of dispute, the Court of Mantova will be competent.

ART. 12 SPECIFICATIONS

All specifications included in this document, in the interest of continuous product improvement and to correct any error, can be changed without notice.

TECLUMEN



light in progress



TECLUMEN
light in progress



ENTIRELY
MADE
IN ITALY

Distributor:

Techni-Lux

Phone: 407-857-8770

Fax: 407-857-8771

Email: sales@techni-lux.com

www.techni-lux.com

TECLUMEN srl

Via Castel Goffredo, 35/1 - 46040 Casaloldo (MN) - Italy

t +39.0376.778670 f +39.0376.778660 - info@teclumen.it - www.teclumen.it