

Light is entertainment
Lighting solutions for
studio, stage and TV

Light is OSRAM

OSRAM

Setting the stage for great art

Stage fright? Not any more. Our products for studio, stage and TV guarantee a smooth and dynamic lighting design – and they offer award-winning technologies. We provide the perfect supporting cast in the form of HMI®, HTI®, Lok-it!®, SIRIUS HRI®, SharXS®, SplitStar® S32, HPL and other halogen studio lamps. Our powerful and effective lighting solutions will benefit the entertainment industry at every level, from professional film productions to small theatrical events. Prestigious awards – such as the Oscar®, the Primetime Emmy® Engineering Award and the PLASA Innovation Award – have encouraged us to maintain the highest standards in lighting for the entertainment industry. Our many years of experience, broad product range and history of innovation provide the perfect platform for continued success.



HMI lamps for film and television were awarded in Hollywood an OSCAR in 1987. Since 1928 OSRAM has been producing lamps for stage lighting, film work and cinema projection.



Acknowledging its outstanding performance and continuous improvement in HMI technology for the TV industry, OSRAM was awarded the Primetime Emmy Engineering Award by the Academy of Television Arts & Sciences.





Light is action

HMI® – every director's darling

OSRAM HMI®
50
YEARS

For 50 years, OSRAM HMI metal halide discharge lamps have been meeting the toughest demands of the film and TV industry. Their technology has received several awards and has become an integral part of film sets around the world.



HMI

HMI lamps are AC-operated metal halide discharge lamps, which have excellent color rendering and photometric integrity throughout their life.

- High intensity light simulates daylight color temperature of 6000K with a CRI >90
- Enormous luminous flux of up to 2.3 million lumens
- Very high luminous efficacy of up to 100 lumens per watt
- Mechanically robust with eXtreme Seal (XS) technology, up to 450°C at the pinch seal
- Capable of hot restrike ignition
- Available in wattages from 200 to 24,000W, single-ended or double-ended
- Dimmable

Perfect light whatever the time – day or night.

With an extremely bright light, providing up to 100 lumens per watt, OSRAM HMI lamps generate a color temperature that closely matches sunlight. It reveals true colors and facilitates daytime filming outdoors. Dimmable, with hot restart capability, OSRAM HMI lamps are up to five times more efficient than an incandescent light.





HMI® STUDIO

With a warm color temperature that closely matches that of tungsten light sources and a CRI >90, HMI STUDIO lamps deliver the sought-after effects of tungsten halogen lamps minus the need for additional fixtures. HMI STUDIO lamps offer an intensely bright light that shines twice as bright as tungsten halogen lamps with similar wattages. Thanks to the patented doped UV-Stop quartz—developed and manufactured in our OSRAM glass factory in Germany—99.9% of harmful UVB and UVC emissions are eliminated. HMI STUDIO lamps last as long as traditional HMI lamps.

- A color temperature of 3200K and high CRI >90.
- A cost-effective alternative to managing and maintaining multiple tungsten halogen and metal halide lamps and fixtures.
- Time savings associated with setting up fewer varieties of lamps, fixtures, and CTO filters to light your set.
- Twice as bright as tungsten halogen lamps with similar wattages.
- Reduction of harmful UVB and UVC emissions by 99.9%, thanks to the special UV-Stop quartz outer jacket.
- A plug-and-play solution for daylight fixtures.
- The same lifespan as our award-winning standard HMI lamps with 6000K color temperature.



HMI® DIGITAL

Whether using film or shooting with a digital camera in modes of 1000 Hz and higher, the OSRAM HMI DIGITAL line has a lamp for your production. While specially designed to accommodate evolving, high-speed film technology, HMI DIGITAL still provides every feature needed to light traditional film productions, as well as theatre stages.

- Flicker-free when used with high-speed electronic ballasts (1000 Hz and higher)
- Suited for both film and digital production
- Up to 99.9% less UV emissions (for ones equipped with UV-Stop)
- Color temperature of 6000K for realistic, naturally-lit scenes
- High color rendering index of >90, exposing true-to-life colors
- Extremely bright light of up to 100 lumens per watt
- Dimmable
- Hot restart capability
- Improved stability and design
- Round moly-foil construction that evenly distributes heat and current, thus extending lamp life¹
- Splash-proof carrying case is reusable and allows lamps to be transported safely¹



STUDIOLINE®

Fluorescent U-bend lamps with a specific phosphor blend are designed for film and video response.

- Two versions available: 3200K and 5500K CCT
- Provides accurate color rendering for video
- Dimmable with color stability
- Soft homogeneous full-coverage light
- Average service life: 8000 hours

Typical applications

- Film, TV and video productions
- Stage lighting (theatre, opera etc.)
- Exhibition lighting
- Lighting for major events
- Professional photography

Typical luminaires

- Follow and moving-head spotlights
- Fresnel luminaires
- PAR/open luminaires
- Soft and flood lighting

¹ 6000–18,000W

Light is performance

Studio halogen lamps

Our studio, stage and TV halogen lamps are excellent examples of the technical advances that can still be achieved in the development of lamps. The key to their success is the combination of high-quality quartz and state-of-the-art lamp technologies. The result is a powerful and economical solution for stage, film and TV lighting.



The culmination of years of experience: technical perfection

Our studio, stage and TV halogen lamps not only meet stringent requirements in terms of luminous flux, luminous efficacy and color temperature, but also through economic and durable operating demands. They are compact, heat-resistant and can be used in many

operating positions. Halogen lamps are manufactured from high-quality components and feature biplanar technology. These innovative filament designs have up to 50% higher luminous intensity in spotlight settings.

The "/X" versions of our stage and studio tungsten halogen lamps have approximately five times longer life than the standard versions, and provide an alternative offering for those who desire less maintenance over higher output.



Halogen lamps

OSRAM studio, stage and TV halogen lamps offer high luminous efficacy with low power consumption, and a relatively high proportion of visible light compared with infrared thermal radiation.

- High output from 500 to 20,000W
- High luminance
- Constant color temperature throughout their lifetime (2850-3400K depending on type)
- Operation at line voltage
- Dimmable
- Eco-friendly: halogen lamps contain no mercury, i.e. no special waste disposal requirements



Large PAR lamps

The workhorse of the industry, Incandescent and Halogen large PAR lamps (200W-1000W) have been seen on stages for as long as people can remember. They are now as iconic as they are bright, and are still used today to achieve a look that is hard to replicate with newer light sources.

PAR 46, PAR 56, and PAR 64 lamps come in a variety of lens options:

- Wide Flood (WFL)
- Medium Flood (MFL)
- Narrow Spot (NSP)
- Very Narrow Spot (VNSP)



HPL

The special filament design increases the life of the high-performance halogen lamp.

- Less maintenance with long-life versions
- Solid nickel pins for precise alignment of the lamp in the holder
- Reinforced pinch seal for extra mechanical stability
- Special metal heat sink for improved heat dissipation and optimized life



Typical applications

- Film, TV and video productions
- Stage lighting (theatre, opera etc.)
- Exhibition lighting
- Lighting for major events
- Professional photography

Typical luminaires

- PAR/open luminaires
- Fresnel lens luminaires
- Soft and flood lighting
- Follow and moving-head spotlights
- Color changers

Light is entertainment in full spectrum

Lok-it!® Power Series

Whether it is in concerts, light shows, theatre, opera, clubs, TV studios and more – there's a growing number of applications that high performance lamps need to cover. That is why we have enhanced our Lok-it! Power Series family to meet an even broader range of applications. Now there are specific lamps suited to the specific needs of the production – all easily identifiable from one another by the name, label, and the lamp base itself.

The OSRAM Lok-it! Power Series packs a lot of power. Now with versions that offer a high CRI of 90 across the range and special features, such as boosting or improved thermal resistance, the Lok-it! Power Series has never been so powerful. Designed to give you broader versatility to meet the needs of a wide array of applications, the latest Power Series lamps provide top performance you can rely on.

The OSRAM Lok-it! Power Series offers:

- Natural tone of light with CRI of 90 (Brilliant: 95)
- Compact size and short arc gap for use in smaller and brighter fixtures
- Higher luminous efficiency than standard HID lamps
- Optimized filling for uniform light emission and reduced output in the green wavelengths common to HID lamps
- “Plug-and-play” base PGJX28 or PGJX36
- OSRAM PGJX28 and PGJX36 ceramic bases allow a high resistance to high voltage up to 35kV



© Ralph Larmann

Lok-it!. The all-around talent.

The bayonet base and lampholder system of the Lok-it! family of lamps allow for a one-handed lamp replacement within just a few seconds. Lok-it! lampholders can be easily installed in luminaires and ensure an extremely strong and vibration-proof connection with the lamp base during operation and transportation. The versatile Lok-it! system enables the user to choose freely between individual lamp technologies (halogen or discharge lamps).

Light is enthusiasm. Celebrations at the Brandenburg Gate in Berlin, Germany, marking the 25th anniversary of the fall of the Berlin Wall.

A clearly defined spotlight sets the stage for a vivid concert experience with natural and brilliant lighting.



© Ralph Larmann

The right lamp for every job

Next to the new and improved standard Lok-it!® 1000/PS, two new varieties take the stage: The all new Brilliant versions with CRI of 95, and Blue with an intense 7500K color temperature for a bright, bluish white light.

Name	Feature	Benefit	Key Application
Lok-it!/PS	950 h	Stable performance and reliability	Concert lighting
Lok-it!/PS Brilliant	CRI 95	Life-like colors and natural skin tones	Theatre lighting
Lok-it!/PS Blue	7500K	Bright whites for cutting through the other colors on stage	Concert lighting

The lamps can also be identified by the color on the bottom of the base making it easier than ever to choose the right lamp.



Lok-it! 1000/PS
The standard lamp of the Lok-it! series comes with a newly-designed cutout in the base, which enables improved heat management in the moving head.



Lok-it! 1000/PS Brilliant
When color brilliance has to be key, the all new Lok-it! 1000/PS Brilliant and Lok-it! 1400/PS Brilliant impress with lifelike colors, thanks to their high CRI of 95.

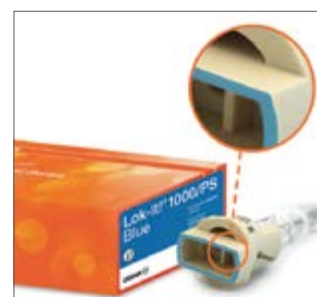

Lok-it! 1000/PS Blue
Crisp light at the switch of a button? The all new Lok-it! 1000/PS Blue delivers 7500K color temperature.

Light is spectacular

SIRIUS HRI® Compact Discharge Lamps



© Ralph Larmann

With the high-performance SIRIUS HRI lamp series, OSRAM has developed discharge reflector lamps which play to their strength, especially in small and lightweight moving head fixtures. They are characterized by high luminance, reduced weight and very compact dimensions with an optimized burner for every operating position. Moreover, they show a very stable light output, as the high luminance decreases

only slightly over the entire lifetime (between 1500 and 6000 hours). The special reflector design allows for an easy and fast lamp replacement, as the burner is already perfectly adjusted within the reflector. SIRIUS HRI is supplied as a complete system including ECG. Combining reliability, efficiency and luminance, the lamps can be used flexibly in various applications of entertainment lighting.

Light is enduring

SharXS® HTI® Family

SharXS HTI has been one of the most reliable lamps in entertainment for more than 15 years, taking the industry by storm and used everywhere.



Double-ended metal halide lamps have enjoyed great success on the entertainment market for many years because of their reliability and performance. Some of their many strengths are:

- Less sensitive to heat
- Always ready for a hot restart
- Allows more compact luminaire design
- Pre-focus base for accurate lamp installation inside the Sfc10-4 lamp holder
- A modular design giving all wattages the same outer dimensions
- eXtreme Seal Technology allows greater thermal loading up to 450°C at the press seal
- Short arc gap between the electrodes provides high luminance

SplitStar® S32 module platform solution

The S32 module is based on innovative multi-chip LED technology – high luminance and luminous flux for the use in entertainment and professional lighting applications.



Features and benefits

- **Up to 20,000 lm (CW)¹**
Cutting-edge performance enables a new generation of LED fixtures with superior light output
- **Up to 140 cd/mm² (CW)¹**
Very high luminance, perfect for beam and spotlights
- **Scalable design**
Customized versions possible
- **LED chips are wired in series circuits**
Chips can be driven with standard voltage and current levels (5A max., SELV)
- **Electrically insulated**
LED module can be mounted directly onto heat sinks

The SplitStar S32 CW – luminance is the key

The pattern of 16 closely arranged LED chips enables a particularly high luminance of up to 140 cd/mm²¹. This far exceeds the average luminance of CoB (chip-on-board) modules of 20 cd/mm². The multi-chip cold white LED module also scores with a high luminous flux of up to 20,000 lm¹ and an integrated temperature-controlled monitoring (NTC). Based on the flexible platform, customized versions in color and layout are possible.

The SplitStar S32 RGBW – with all the familiar features of the S32

The S32 RGBW contains four 2mm² high-current chips per color. Thanks to the low thermal resistance of 0.05 K/W², each chip can be operated with up to 5A (red 4A), which generates a large amount of light from a small surface. The integrated temperature control via NTC allows continuous operation. Typical target applications of the S32 RGBW are stage spotlights of any size, though the module is equally suited for use in mood lights, as effect lighting for accents or as architectural lighting. By mixing different S32 RGBW values, you can create a wide range of colors, including pastel shades.

SplitStar S32 RGBA (full white), the latest member of the SplitStar family

The RGBA full white version features an adjustable white point and a high CRI along the Planckian locus. Four independent control channels with red, green, amber and blue provide a controllable color temperature mix between 2700 and 7000K. The S32 RGBA is the perfect choice for any application requiring adjustable color temperatures in combination with a continuous high CRI and the well-known high luminance and luminous flux of the SplitStar family.

SplitStar solution partners

- Dedicated optical solution based on light guide available at Auer Lighting.
- Dedicated electronic driver available at ITG – Illuminance Technologies Group.
- Dedicated LED holder for electrical connection available at Bender & Wirth.

¹ Pulse mode operation @25°C

² NTC to backplane

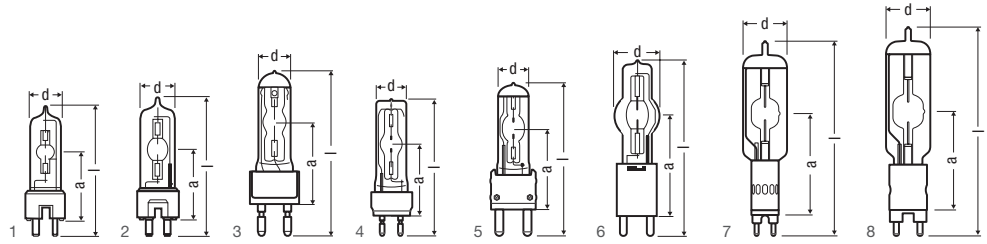

HMI® DIGITAL lamp types

Lamp Description	Product Number	Watts	Volts	Current (Amps)	Base	Lumens	Avg Rated Life (hrs)	Color Temp (K)	Diameter (d) (mm)	LCL (a) (mm)	Length (l) (mm)	Line Drawing No.
HMI DIGITAL 200W	55072	200	70	3	GZY9.5	16000	200	6000	20	39	80	1
HMI DIGITAL 400W	55073	400	75	5.3	GZZ9.5	33000	650	6000	23	60	110	2
HMI DIGITAL 575W	55074	575	94	6.1	G22	49000	1000	6000	30	70	145	3
HMI DIGITAL 800W	55076	800	95	8.4	G22	69000	1000	6000	30	70	145	3
HMI DIGITAL 1200W	55077	1200	100	12	G38	110000	1000	6000	42	107	200	5
HMI DIGITAL 1600W	TBD	1600	150	10.7	G22	150000	750	6000	38	85	175	4
HMI DIGITAL 1800W	55078	1800	140	13	G38	165000	750	6000	42	107	200	5
HMI DIGITAL 2500W	55182	2500	115	25.6	G38	240000	500	6000	60	127	225	6
HMI DIGITAL 4000W	55081	4000	200	24	GX38	380000	500	6000	75	142	250	6
HMI DIGITAL 6000W	TBD	6000	123	55	GX38	600000	500	6000	75	210	360	7
HMI DIGITAL 9000W	TBD	9000	160	56	GX38	875000	400	6000	80	210	380	7
HMI DIGITAL 12000W ¹	TBD	12000	160	76	GX38	1150000	500	6000	100	255	455	7
HMI DIGITAL 18000W ¹	TBD	18000	225	88	GX51	1600000	350	6000	100	260	495	8

¹ Without UVS

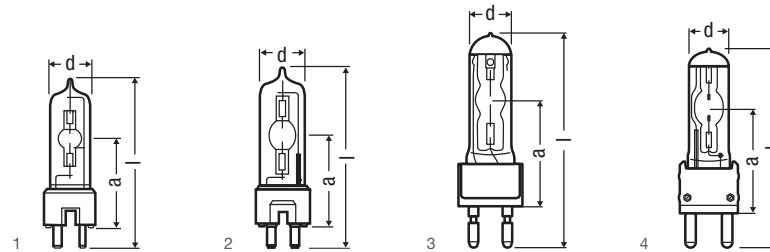

HMI® STUDIO lamp types

Lamp Description	Product Number	Watts	Volts	Current (Amps)	Base	Lumens	Avg Rated Life (hrs)	Color Temp (K)	Diameter (d) (mm)	LCL (a) (mm)	Length (l) (mm)	Line Drawing No.
HMI STUDIO 200W	55176	200	70	3	GZY9.5	12800	200	3200	20	39	80	1
HMI STUDIO 400W	55177	400	70	6.9	GZZ9.5	26400	650	3200	23	60	110	2
HMI STUDIO 575W	55178	575	95	6.9	G22	39200	1000	3200	30	70	145	3
HMI STUDIO 800W	55179	800	95	8.4	G22	52000	1000	3200	30	70	145	3
HMI STUDIO 1200W	55180	1200	100	12	G38	88000	1000	3200	42	107	200	4
HMI STUDIO 1800W	55181	1800	140	13	G38	132000	750	3200	42	107	200	4

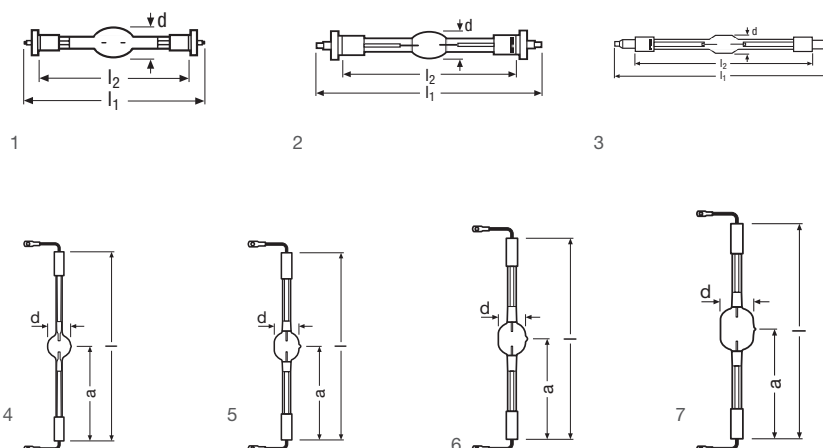

HMI® double-ended

Lamp Description	Product Number	Watts	Volts	Current (Amps)	Base	Lumens	Avg Rated Life (hrs)	Color Temp (K)	Diameter (d) (mm)	LCL (a) (mm)	Length (l) (mm)	Operating Position	Line Drawing No.
HMI 575 W/DXS	54313	575	95	6	SFc10-4	49000	1000	6000	21	135	115	Any	1
HMI 1200 W/DXS	55139	1200	100	13.8	SFc15.5	110000	1000	6000	27	220	180	Any	2
HMI 2500 W/S XS	54265	2500	115	25.6	SFa21-12	240000	500	6000	31.5	210	150	p30	3
HMI 2500 W/DXS	54068	2500	115	25.6	SFa21	240000	500	6000	31.5	355	290	p30	3
HMI 4000 W/DXS	54314	4000	200	24	SFa21	380000	500	6000	36	405	340	p15	3
HMI 6000 W/DXS	54315	6000	123	55	S25.5	570000	500	6000	54	450	TBD	p15	4
HMI 12000 W/DXS	54316	12000	160	84	S30	1150000	500	6000	64	470	TBD	p15	5
HMI 18000 W/DXS	54213	18000	225	86	S30	1700000	500	6000	70	500	TBD	p15	6
HMI 24000 W/DXS	54325	24000	280	88	S30	2300000	500	6000	83	500	TBD	p15	7

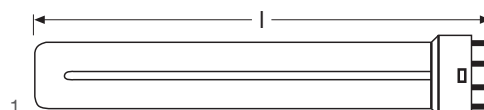

STUDIOLINE®

Lamp Description	Product Number	Watts	Base	Bulb Shape	Lumens	CRI	Avg Rated Life (hrs)	Color Temp (K)	Length (l) (mm)	Line Drawing No.
STUDIOLINE 55W/3200	20607	55	2G11	T5	3800	85	8000	3200	535	1
STUDIOLINE 55W/5600	20608	55	2G11	T5	3800	85	8000	5600	535	1



STAGE & STUDIO HALOGEN >120V

Lamp Description	Product Number	Watts	Volts	Base	Bulb Shape	Lumens	Avg Rated Life (hrs)	Color Temp (K)	LCL (mm)	Operating Position
64672 M/40 230V	54951	500	230	GY9.5	T7	8500	2000	2900	46.5	Any
64672 M/40 240V	54964	500	240	GY9.5	T7	8500	2000	2900	46.5	Any
64680 A1/244 230V	54965	500	230	GY9.5	T7	14500	50	3200	36.5	Any
64680 A1/244 240V	54969	500	240	GY9.5	T7	14500	50	3200	36.5	Any
64670 T/25 GCV 230V	54495	500	230	GY9.5	T6.5	11000	300	3000	46.5	s90
64670 T/25 GCV 240V	54496	500	240	GY9.5	T6.5	11000	300	3000	46.5	Any
64716 GKV 230V	54493	600	230	G9.5	T6	13500	300	3050	60.5	Any
64716 GKV 240V	54494	600	240	G9.5	T6	13500	300	3050	60.5	Any
64717 CP/89 FRL	54489	650	230	GY9.5	T6.5	16250	150	3200	46.5	s90
64717 CP/89 FRM	54490	650	240	GY9.5	T6.5	17000	150	3200	46.5	Any
64718 T/27 GCT 230V	54491	650	230	GY9.5	T6.5	14850	400	3000	46.5	s90
64718 T/27 GCT 240V	54492	650	240	GY9.5	T6.5	14850	400	3000	46.5	s90
64678	54497	800	230	G9.5	T6	20000	250	3200	2.4	Any
64575 230V	58525	1000	230	GX6.35	T7	33000	15	3400	38	Any
FKJ 64747 CP/711000W 230V	54669	1000	230	G22	T7	26000	200	3200	63.5	s90
FEP/240	54515	1000	240	G9.5	T6	23000	150	3200	60.3	Any
64787 CP/75	54539	2000	230	G22	T10	52000	400	3200	75	s90
64789 CP/73 FKK 230V	54540	2000	230	G38	T10	52000	400	3200	127	s90
64789 CP/73 FKK 240V	54541	2000	240	G38	T10	52000	400	3200	127	s90
64788 CP/72 FTM 230V	54484	2000	230	GY16	T10	52000	400	3200	70	s90
64788 CP/72 FTM 240V	54485	2000	240	GY16	T10	52000	400	3200	70	s90
64777 CP/92	54486	2000	230	G22	T10	52000	400	3200	90	s90
64796 CP/91	54538	2500	230	G22	T10	65000	400	3200	90	s90
64797 3000W G38	54389	3000	230	G38	BT15	82000	400	3200	127	s45
64805 CP/85 230V	54552	5000	230	G38	T19	135000	400	3200	165	s45
64805 CP/85 240V	54553	5000	240	G38	T19	135000	400	3200	165	s45
ECR 64815 CP/83 230V	54702	10000	230	G38	T22	280000	400	3200	254	s45
BCM 208V	54713	20000	208	G38	T31	570000	400	3200	354	s45
BCM 64818 CP/99 20KW 230V	54342	20000	230	G38	T31	570000	350	3200	354	s45
HPL575/230 (UCF)	54618	575	230	G9.5 W/HSINK	T6	14900	400	3200	60.3	Any
HPL575/230/X (UCF)	54665	575	230	G9.5 W/HSINK	T6	11780	1500	3050	60.3	Any
HPL575/240 (UCF)	54619	575	240	G9.5 W/HSINK	T6	14900	400	3200	60.3	Any
HPL575/240/X (UCF)	54703	575	240	G9.5 W/HSINK	T6	11780	1500	3050	60.3	Any
HPL750/230 (UCF)	54603	750	230	G9.5 W/HSINK	T6	19750	300	3200	60.3	Any
HPL750/230/X (UCF)	54670	750	230	G9.5 W/HSINK	T6	15600	1500	3050	60.3	Any
HPL750/240 (UCF)	54614	750	240	G9.5 W/HSINK	T6	19750	300	3200	60.3	Any
HPL750/240/X (UCF)	54704	750	240	G9.5 W/HSINK	T6	15600	1500	3050	60.3	Any

STAGE & STUDIO HALOGEN ≤120V

Lamp Description	Product Number	Watts	Volts	Base	Bulb Shape	Lamp Type	Lumens	Avg Rated Life (hrs)	Color Temp (K)	LCL (mm)
DWE	54500	650	120	Screw Terminal	PAR36	PAR36	24000	100	3200	N/A
FDN 120V	54534	500	120	R7s	T2.5	Double End	12800	400	3200	N/A
EJG 120V	54598	750	120	R7S	T3	Double End	20600	400	3200	N/A
DXW	53997	1000	120	R7s	T5	Double End	28000	150	3200	N/A
FFT 120V	54350	1000	120	R7s	T3	Double End	27000	300	3200	N/A
FDB 120V	54435	1500	120	R7s	T12	Double End	41200	400	3200	N/A
FCM 120V	54442	1000	120	R7s	T3	Double End	28000	400	3200	N/A
FHM 120V	54532	1000	120	R7s	T3	Double End	27300	300	3200	N/A
FEY	54559	2000	120	RX7S RRSC	T8	Double End	57400	400	3200	N/A
FAD	54574	650	120	R7s	T4	Double End	16500	100	3200	N/A
FEV	54441	200	120	BA15d	T12	Single End	5500	50	3200	34.9
FVL	54459	200	120	GX5.3	T12	Single End	5200	200	3200	32
GLF	54460	235	230	G5.3	T12	Single End	5100	100	3100	32
GCA	54428	250	120	G5.3	T3	Single End	5700	200	3200	32
DYS/300	58497	300	120	GZ9.5	T6	Single End	7500	100	3200	36.5
FKW	54711	300	120	GY9.5	T6	Single End	7800	200	3200	46.5
HP 375W 115V GLG	54520	375	115	G9.5	T6	Single End	10000	300	3250	60.45
HP 375W/115V/X GLH	54525	375	115	G9.5	T6	Single End	7500	2000	3050	60.5
FTK	54875	500	120	GY9.5	T6	Single End	12000	200	3200	36.5
EFX	54787	500	120	G22	T5	Single End	10000	2000	3000	101.6
EHC/EHB	54506	500	120	G9.5	T12	Single End	13000	300	3200	60.3
EHD	54508	500	120	G9.5	T4	Single End	10600	2000	3200	60.3
FRG	54629	500	120	GY9.5	T6	Single End	13000	150	3200	46.5
EGE	54648	500	120	P28S	T5	Single End	10000	2000	3000	88.9
EGN	54659	500	120	G22	T6	Single End	13000	100	3200	63.5
FLK	54589	575	115	G9.5	T6	Single End	16500	300	3200	59.1
FLK/X 115V	54551	575	115	G9.5	T5	Single End	10000	2000	3200	59.1
GLC 575/115/300	54507	575	115	G9.5	T6	Single End	15500	300	3250	60.5
GLA	54516	575	115	G9.5	T6	Single End	13500	1500	3050	60.5
BHC/DYS/DYV	54836	600	120	GZ9.5	T6	Single End	17500	75	3200	36.5
BHC/DYS/DYV-5	54835	600	125	GZ9.5	T6	Single End	17500	75	3200	36.5
FRK	54631	650	120	GY9.5	T7	Single End	16900	200	3200	46.5
EHF	54510	750	120	G9.5	T5	Single End	20400	300	3300	60.3
EHG	54512	750	120	G9.5	T5	Single End	15400	2000	3000	60.3
GLD 750/115/300	54522	750	115	G9.5	T6	Single End	19000	300	3250	60.5
GLE 750/115/1500	54523	750	115	G9.5	T6	Single End	17400	1500	3050	60.5
EGR	54662	750	120	G22	T7	Single End	20000	200	3200	63.5
EGG	54652	750	120	P28S	T5	Single End	15000	2000	3000	88.9
EGT	54664	1000	120	G22	T6	Single End	27500	250	3200	63.5
FEL	54570	1000	120	G9.5	T6	Single End	27500	300	3200	60.3
EGJ	54654	1000	120	P28S	T6	Single End	25500	400	3200	88.9
EGK	54656	1000	120	P28S	T6	Single End	24500	400	3200	88.9
BTL	54685	500	120	P28S	T6	Single End	11000	750	3050	55.6
BTH	54365	575	115	P28S	T6	Single End	15500	300	3250	55.6
BTM	54686	500	120	P28S	T6	Single End	13000	100	3200	55.6
BTN	54687	750	120	P28S	T6	Single End	17000	500	3200	55.5
BTP	54688	750	120	P28S	T7	Single End	20000	200	3200	55.5
BTR	54689	1000	120	P28S	T6	Single End	27500	250	3200	55.5
BVT	54690	1000	120	P40S	T7	Single End	23000	500	3050	100
BVV	54691	1000	120	P40S	T6	Single End	27500	200	3200	100
BVW	54692	2000	120	P40S	T9.5	Single End	59000	280	3200	100
HPL 375/115 (UCF)	54625	375	115	G9.5 W/HSINK	T6	Single End	10540	300	3200	60.3
HPL 375/115/X (UCF)	54649	375	115	G9.5 W/HSINK	T8	Single End	8000	1000	2950	60.3
HPL 550/77 (UCF)	54623	550	77	G9.5 W/HSINK	T6	Single End	16170	300	3265	60.3
HPL 550/77/X (UCF)	54604	550	77	G9.5 W/HSINK	T6	Single End	12160	2000	3065	60.3

STAGE & STUDIO HALOGEN ≤120V (Continued)

Lamp Description	Product Number	Watts	Volts	Base	Bulb Shape	Lamp Type	Lumens	Avg Rated Life (hrs)	Color Temp (K)	LCL (mm)
HPL 575/115 (UCF)	54622	575	115	G9.5 W/HSINK	T6	Single End	16520	300	3265	60.3
HPL 575/115/X (UCF)	54807	575	115	G9.5 W/HSINK	T6	Single End	12360	2000	3065	60.3
HPL 575/120 (UCF)	54817	575	120	G9.5 W/HSINK	T6	Single End	16460	300	3265	60.3
HPL 575/120/X (UCF)	54815	575	120	G9.5 W/HSINK	T6	Single End	12360	2000	3050	60.3
HPL 750/77 (UCF)	54825	750	77	G9.5 W/HSINK	T6	Single End	22950	300	3265	60.3
HPL 750/115 (UCF)	54602	750	115	G9.5 W/HSINK	T6	Single End	21900	300	3265	60.3
HPL 750/115/X (UCF)	54611	750	115	G9.5 W/HSINK	T6	Single End	16400	1500	3050	60.3
HPL 750/120 (UCF)	54605	750	120	G9.5 W/HSINK	T6	Single End	21900	300	3250	60.3
HPL 750/120/X (UCF)	54653	750	120	G9.5 W/HSINK	T6	Single End	16400	2000	3065	60.3
QXL 750/77	54882	750	77	QXL	T6	Single End	22950	300	3250	38.0
QXL 750/77/X	54883	750	77	QXL	T6	Single End	18000	1500	3050	38.0
HP 1200/80	54855	1200	80	G22	T8	Single End	37500	250	3200	63.5
1200W/80V/32/P50 LOK-IT	54871	1200	80	PGJX50	T8	Single End	37500	250	3200	84
1200W 120V GX9.5	55035	1200	120	GX9.5	T8	Single End	34200	150	3200	55
DTA	54716	1500	120	P40S	T8	Single End	39000	100	3200	87.3
CYV	54706	1000	120	G38	T7	Single End	27500	200	3200	127
CYX	54613	2000	120	G38	T11	Single End	55000	300	3200	127
DPY 120V	54554	5000	120	G38	T19	Single End	143000	500	3200	165
DTY	54696	10000	120	G38	T24	Single End	290500	350	3200	254
HAL 12000W 120V	53985	12000	120	G38	T26	Single End	420000	150	3400	254



Large PAR

Lamp Description	Product Number	Watts	Volts	Base	Bulb Shape	Lens Type	Lumens (lm)	Avg Rated Life (hrs)	Color Temp (K)
200PAR46/3NSP 120V	15191	200	120	Med. Side Prong	PAR46	NSP	2850	2000	2270
200PAR46/3MFL 120V	15194	200	120	Med. Side Prong	PAR46	MFL	2850	2000	2270
300W PAR56 NSP 120V	55163	300	120	GX16D	PAR56	NSP	2850	2000	3840
300W PAR56 MFL 120V	55164	300	120	GX16D	PAR56	MFL	2850	2000	3840
300W PAR56 WFL 120V	55165	300	120	GX16D	PAR56	WFL	2850	2000	3840
200W PAR56 MFL 120V	55167	200	120	GX16D	PAR56	MFL	2850	2000	2270
500W PAR56Q NSP 120V	55173	500	120	GX16D	PAR56	NSP	2950	4000	8000
500W PAR56Q HAL MFL 120V	55174	500	120	GX16D	PAR56	MFL	2950	4000	8000
500W PAR56Q HAL WFL 120V	55175	500	120	GX16D	PAR56	WFL	2950	4000	8000
500W PAR64 MFL 120V	55159	500	120	GX16D	PAR56	MFL	2850	2000	6500
500W PAR64 WFL 120V	55160	500	120	GX16D	PAR56	WFL	2850	2000	6500
500W PAR64 NSP 120V	55161	500	120	GX16D	PAR56	NSP	2850	2000	6500

Large PAR (Continued)

Lamp Description	Product Number	Watts	Volts	Base	Bulb Shape	Lens Type	Lumens (lm)	Avg Rated Life (hrs)	Color Temp (K)
1000PAR64Q/HAL/NSP 120V	56206	1000	120	GX16D	PAR64	NSP	2950	4000	19400
1000PAR64Q/HAL/MFL 120V	56207	1000	120	GX16D	PAR64	MFL	2950	4000	19400
1000PAR64Q/HAL/WFL 120V	56208	1000	120	GX16D	PAR64	WFL	2950	4000	19400
1000W PAR64 VNSP FFN 120V	56214	800	GX16D	VNSP	PAR64	3200	120	1000	400000
1000W PAR64 NSP FFP 120V	56215	800	GX16D	NSP	PAR64	3200	120	1000	330000
1000W PAR64 WFL FFS 120V	56216	800	GX16D	WFL	PAR64	3200	120	1000	40000
1000W PAR64 MFL FFR 120V	56217	800	GX16D	MFL	PAR64	3200	120	1000	125000

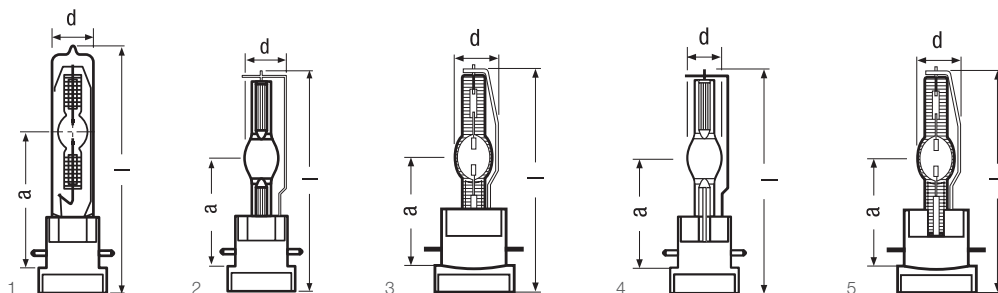

Lok-it!® lamp types

Lamp Description	Product Number	Watts	Volts	Current (Amps)	Base	Lumens	Avg Rated Life (hrs)	CRI	Color Temp (K)	Electrode Gap (Cold) (mm)	MOL (mm)	Line Drawing No.
Lok-it! Metal Halide												
HSD 300/80/P28 LOK-IT	54382	300	95	3.2	PGJX28	27000	2000	8000	85	5	122	1
HTI 700W/60/P28 LOK-IT	54727	700	64	10	PGJX28	50000	750	6000	85	4	117	2
HTI 700W/75/P28 LOK-IT	54221	700	80	8.8	PGJX28	50000	750	7500	85	4	117	2
HTI 700W/75/P50 LOK-IT	54229	700	90	7.8	PGJX50	50000	750	7500	85	4	125	3
HTI 1500W/60/P50 LOK-IT	54225	1500	100	16	PGJX50	135000	750	6000	90	5.5	128	5
HTI 1500W/60/P50 M3W LOK-IT	54396	1500	100	16	PGJX50	125000	750	6000	90	7	128	5
Lok-it! Power Series												
LOK-IT 1000/PS	55022	1000	85	11.8	PGJX36	85000	750	6000	85	5.5	112	4
LOK-IT 1000/PS BLUE	55025	1000	85	11.8	PGJX36	75000	750	7500	85	5.5	112	4
LOK-IT 1000/PS BRILLIANT	55024	1000	85	11.8	PGJX36	82000	750	6000	95	5.5	112	4
LOK-IT 1400/PS BRILLIANT	55026	1400	90	15.5	PGJX28	120000	750	6000	95	5.5	125	4
LOK-IT 1700/PS	55027	1700	85	20	PGJX28	140000	750	6000	92	5.5	125	4
Lok-it! Halogen												
LOK-IT 1200W/80V/32/P50	54871	1200	80	15	PGJX50d	37500	250	3200	100	N/A	140	-

Technical data

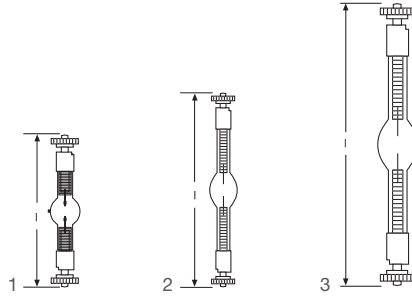

SharXS® HTI lamps

Lamp Description	Product Number	Watts	Volts	Base	Lumens	Avg Rated Life (hrs)	CRI	Color Temp (K)	Electrode Gap (Cold) (mm)	MOL (mm)	Line Drawing No.
HTI 300W/D5/57 BABY SHARXS	54298	300	75	SFC10-4	20000	3000	5700	80	5.5	93	1
HTI 300W/D5/65 BABY SHARXS	54299	300	95	SFC10-4	22000	750	6500	85	5.5	93	1
HTI 575W/D5/56 BABY SHARXS	54359	575	93	SFC10-4	43000	500	5600	85	5	93	1
HTI 400W/D3/75 SHARXS	54241	400	50	SFC10-4	26000	1000	7500	80	3	136	2
HTI 700W/D4/60 SHARXS	54282	700	70	SFC10-4	59000	750	6000	80	4	136	2
HTI 700W/D4/75 SHARXS	54242	700	70	SFC10-4	59000	750	7500	80	4	136	2
HTI 1200W/D7/60 SHARXS	54268	1200	95	SFC10-4	110000	750	6000	90	7	136	2
HTI 1200W/D7/75 SHARXS	54269	1200	95	SFC10-4	110000	750	7500	80	7	136	2
HTI 1500W/D7/60 SHARXS	54319	1500	110	SFC10-4	145000	750	6000	90	7	136	2
sHTI 2000W/D10/60 MAXI SHARXS	54328	2000	105	SFC15.5	200000	750	6000	90	10	220	3

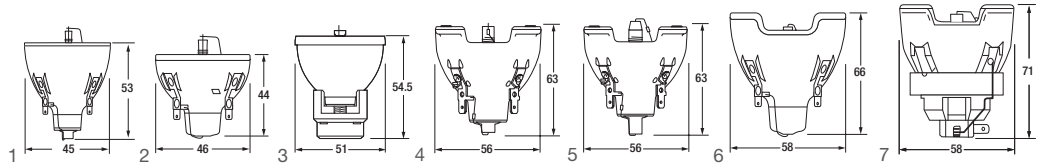

SIRIUS® HRI lamps

Lamp Description	Product Number	Watts	Lumens	Avg Rated Life (hrs)	Color Temp (K)	CRI	Electrode Gap (Cold) (mm)	Reflector	Working Distance (mm)	Line Drawing No.
SIRIUS HRI 100W	54218	100	3680	6000	9000	60	1.0	E18	30.0	1
SIRIUS HRI 132W	54476	132	5150	6000	9200	60	1.0	E19	37.7	2
SIRIUS HRI 140W RO	54750	140	5250	6000	9200	60	1.0	E19	37.7	2
SIRIUS HRI 5R 190W+	54402	190	8100	3000	8200	73	0.8	E20.6	34.5	3
SIRIUS HRI 230W	54403	230	9500	2500	8000	75	1.0	E20.6	34.5	3
SIRIUS HRI 280W RO	54498	280	11500	2000	7800	78	0.9	E20.6	35.5	3
SIRIUS HRI 330W	54405	330	15000	1500	7400	86	1.0	E21.8s	31.0	4
SIRIUS HRI 330W XL	54714	330	12000	1500	7250	71	1.3	E21.8	36.0	5
SIRIUS HRI 330W X8	54738	330	13500	1500	8000	85	1.2	E21.9	37.4	6
SIRIUS HRI 440W	54626	440	22800	1500	7000	80	1.3	E21.9	41.0	7
SIRIUS HRI 440W S	54615	440	22800	1500	7000	80	1.3	E21.9	37.4	7
SIRIUS HRI 470W RO	55084	470	24000	1500	7500	80	1.3	E20.8	48.0	7

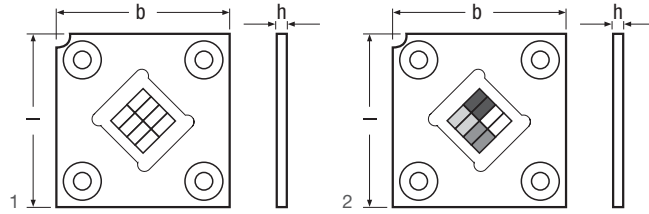

SplitStar® S32 modules

Lamp Description	Product Number	Watts	Current per Channel (max.) (A)	Color Temp (K)	Average Luminance (cd/mm ²)	Lumens	Width (b) (mm)	Length (l) (mm)	Height (h) (mm)
SplitStar S32 CW	TBD	300	5	6200	140 ¹	20000 ¹	25.4	25.4	2.53
SplitStar S32 RGBW	TBD	277	Red 4	Red 638 nm	70 ¹	Red 1450 ^{1,3}	25.4	25.4	2.53
			Green 5	True Green		Green 2825 ^{1,3}			
			Blue 5	524 nm		Blue 2100 ^{1,3}			
			White 5	Deep Blue		White 5000 ^{1,3}			
				446 nm					
			White 6200K						
SplitStar S32 RGBA	TBD	180	converted	2700–7000	70 ¹	10000 ^{1,3}	5.4	25.4	2.53
			Amber 3						
			Green 5						
			Red 4						
			Blue 5						

Lamp Description	Number of Channels	CRI	Temperature Control	Thermal Resistance R _{th} (module) (K/W)	Operating Temperature (C°)	Viewing Angle (°)	Emitting Area (mm ²)	Line Drawing No.
SplitStar S32 CW	2	70	NTC	0.05 ⁴	-25...120 ²	180	6.9x6.7	1
SplitStar S32 RGBW	4	–	NTC	0.05 ⁴	-25...120 ²	180	6.9x6.7	2
SplitStar S32 RGBA	4	≤93	NTC	0.05 ⁴	-25...120 ²	180	6.9x6.7	2

¹Pulse mode operation @25°C

²NTC reading

³Not on Planckian locus

⁴NTC to backplane

OSRAM

Americas Headquarters

OSRAM SYLVANIA Inc.
200 Ballardvale Street
Wilmington, MA 01887 USA
Phone 1-978-570-3000
www.osram-americas.com

OSRAM

Professional and Industrial Applications
Specialty Lighting

OSRAM SYLVANIA Inc.
129 Portsmouth Avenue
Exeter, NH 03833
United States: 888-677-2627
Canada: 800-729-3777
Mexico: 525-899-1807

Distributor:

Techni-Lux
www.techni-lux.com

Phone: 407-857-8770
Fax: 407-857-8771
Email: sales@techni-lux.com

OSRAM is a registered trademark of OSRAM GmbH.
OSCAR is a registered trademark of the Academy of Motion Picture Arts and Sciences.
All other trademarks are property of their respective owners.

© 2017 OSRAM SYLVANIA Inc.

OSRAM