

NEW PRODUCTS GUIDE



WHAT GREAT SYSTEMS ARE BUILT ON™

WHAT GREAT SYSTEMS ARE BUILT ON™

RACKS AND ENCLOSURES	pg. 4
DISPLAY MOUNTS	pg. 7
TECHNICAL FURNITURE	pg. 12
POWER	pg. 22
C2G® CONNECTIVITY	pg. 27
WIREMOLD® CABLE MANAGEMENT	pg. 32
ACCESSORIES	pg. 33
E-TOOLS	PG. 35

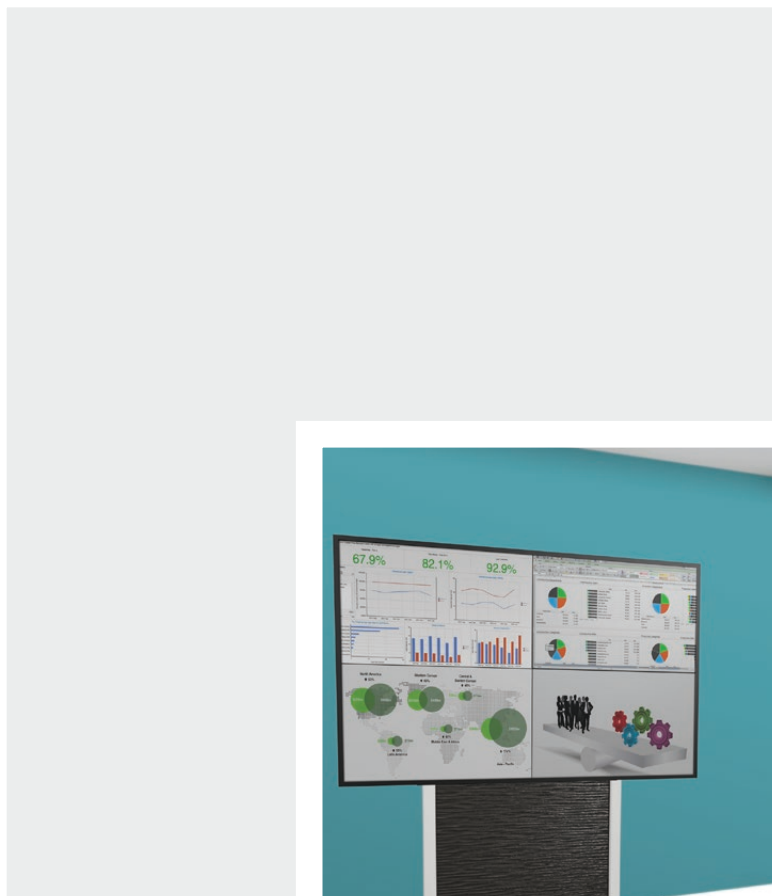

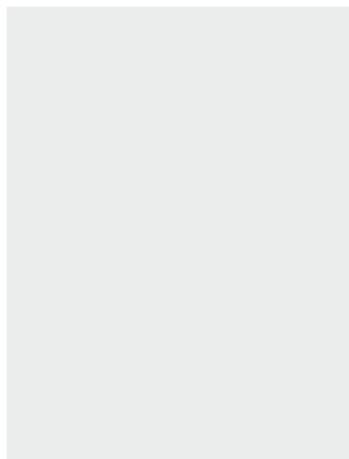

Middle Atlantic Products, an AV brand of Legrand, has manufactured exceptional support and protection products to mount integrated AV systems in Residential, Commercial, Broadcast, and Security applications since 1979. Offering innovative system enclosures, tech-enabled furniture and power products as well as Wiremold® cable management and C2G® connectivity solutions, Middle Atlantic is committed to providing complete and unmatched AV infrastructure solutions and services.

At the heart of a great AV experience, you'll find Middle Atlantic Products - what great systems are built on™.

NEW

RACKS AND ENCLOSURES

VWM Series



MOST VERTICAL VERSATILITY

LOW-PROFILE WALL CABINET



The VWM Series is the industry's highest capacity and most versatile low profile wall cabinet. This patent-pending design features multiple planes of vertical mounting, it allows deeper equipment to be mounted parallel to the wall, and is the first low profile cabinet to offer intuitive mounting for small devices. VWM cabinets are ideal for small to medium networking, surveillance and monitoring, distributed audio and paging systems. Select one of our pre-configured models or tailor a VWM cabinet to order for the specific needs of the application at middleatlantic.com.

- Maximizes space and expertly handles the highest density of components
- Unique design allows mounting of rackrail where it's needed: left, center or right justified and multiple vertical positions
- Choose pivoting or fixed rackrail: with multiple RU options available, all rackrail features both 10-32 thread and cage nut



- Outfit the cabinet's backpan or door with Lever Lock™ to mount small devices
- Available in 10" or 16" depth from the wall (up to 5 or 8RU) and 36" or 42" height along the wall (up to 31" or 37" useable depth)
- Supports thermal management, cable integrity, power distribution and maximizing space while providing a secure location for components of all sizes in an all-in-one system



CERTIFICATIONS

- UL Listed
- GREENGUARD Certified
- Product Environmental Profile

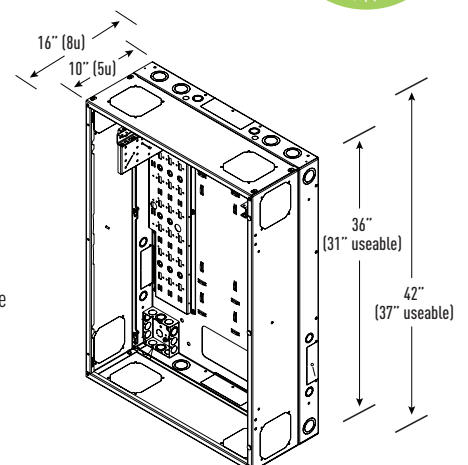

RACKS AND ENCLOSURES

VWM Series

NEW

PRE-CONFIGURED MODELS



models that meet your specific application



putty or black color



2-gang electrical box and fixed or pivoting rackrail



full or split doors (top plexi or solid)

*Additional options including more colors, greater flexibility in door configuration as well as equipment mounting additions available when configuring the VWM in the design tool.

Pre-Configured Part #	Door	Rackrail Included	Height	Depth	Finish	Replaces
VWM-2-2-36K-PW	Solid	2 pivot RU, 2 fixed RU	36"	12"	putty	HDR-4
VWM-4-5-36K-PW	Solid	4 pivot RU, 5 fixed RU	36"	12"	putty	HDR-9
VWM-4-5-42K-PW	Solid	4 pivot RU, 5 fixed RU	42"	12"	putty	HDR-9X
VWM-SD-4-36K-BW	Split, solid top	4 fixed RU	36"	12"	black	WRS-4
VWM-SD-6-36K-BW	Split, solid top	6 fixed RU	36"	18"	black	WRS-6
VWM-SD-8-36K-BW	Split, solid top	8 fixed RU	36"	18"	black	WRS-8
VWM-PD-4-36K-PW	Split, plexi top	4 fixed RU	36"	12"	putty	WRS-4
VWM-PD-6-36K-PW	Split, plexi top	6 fixed RU	36"	18"	putty	WRS-6
VWM-PD-8-36K-PW	Split, plexi top	8 fixed RU	36"	18"	putty	WRS-8

UNIQUE OPTIONS VWM SERIES



fixed and pivoting rackrail



Lever Lock™ back pan & front door kits

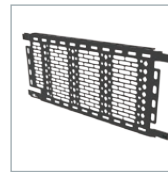

17" vertical Lever Lock™ Accessories



backpan brush grommet

OPTIONS AND ACCESSORIES

	Part #	Rail Type	Useable Rackspace	Mounting Configurations	Fits 10" Deep VWM	Fits 14" Deep VWM
Rackrail Options*	VWM-RR-2	fixed	2	horizontal vertical diagonal	X	X
	VWM-RR-4	fixed	4		X	X
	VWM-RR-5	fixed	5		X	X
	VWM-RR-6	fixed	6			X
	VWM-RR-8	fixed	8			X
	VWM-RR-PIV-2	pivoting	2	100°	X	X
	VWM-RR-PIV-4	pivoting	4		X	X

*all rackrail options feature both 10-32 thread and cage nut

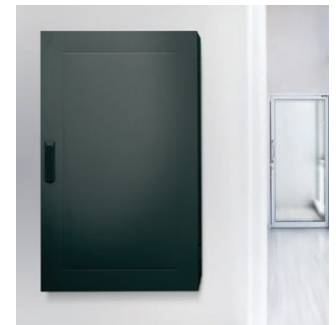

	Part #	Description
Accessories	LL-VWM-BPK	Lever Lock™ backpan kit, includes 6" Lever Lock plate (LL-VP176-SWP)
	LL-VWM-36SP	Lever Lock™ front door kit fits 36" split door, includes 10" Lever Lock plate (LL-VP1710)
	LL-VWM-36S-42SP	Lever Lock™ front door kit fits 36" solid/42" split door, includes 10" Lever Lock plate (LL-VP1710)
	LL-VWM-42S	Lever Lock™ front door kit fits 42" solid door, includes 10" Lever Lock plate (LL-VP1710)
	LL-VP176-SWP	17" high 6" deep, vertical Lever Lock™ plate features structured wiring pattern
	VWM-6BR-BP	back pan brush grommet



LOOKING TO CUSTOMIZE?

Design a VWM solution that fits your precise needs at middleatlantic.com

RACKS AND ENCLOSURES

SR Series



A WIDER RACK THAT SAVES SPACE

The innovative SR Series Pivoting Wall Rack combines the capacity of a floor standing rack with the compact footprint of a wall rack to handle a broad range of AV, security, broadcast and data installations



ALSO AVAILABLE IN STANDARD WIDTHS



- Pivots 90° on floor base to easily access rear equipment connections for more overall space savings than a full height, floor standing enclosure
- Installation ease with the patented Tool Free Quick-Mount™ system for center section mounting to the backpan
- “Bonus” 4 rackspace in base for mounting a UPS or other equipment
- Additional 3 rackspace at the top for patching and other small equipment mounting
- Industry’s first seismic rated wall rack series, delivering tip and/or vibration resistance when its desired or required
- Standard, adjustable front 10-32 threaded rackrail with numbered spaces for built-in cable management
- Flexible cable entry access at the top, bottom and sides of the rack with additional knockouts for electrical box and fans
- Sub plate allows mounting of 89D blocks and other connectivity accessories
- Standard options available to meet the needs of your installation requirements:
 - Corner mounting or side-by-side rack installation capability with the optional zero clearance latch
 - Choices of plexi, solid, or vented doors available depending upon desired level of visibility and need for additional airflow

CERTIFICATIONS

- Seismic Certified
- UL Listed
- GREENGUARD Certified
- Product Environmental Profile

	Part #	Description	Dimensions
STANDARD	SR-24-28	23.5" Wide Large Pivoting Wall Rack	28 3/8" D X 62 3/4" H
	SR-24-32	23.5" Wide Large Pivoting Wall Rack	32 3/8" D X 62 3/4" H
	SR-40-22	23.5" Wide Large Pivoting Wall Rack	22 3/8" D X 90 3/4" H
	SR-40-28	23.5" Wide Large Pivoting Wall Rack	28 3/8" D X 90 3/4" H
	SR-40-32	23.5" Wide Large Pivoting Wall Rack	32 3/8" D X 90 3/4" H
	SR-46-28	23.5" Wide Large Pivoting Wall Rack	28 3/8" D X 101 1/4" H
NEW WIDTH	SR28-24-32	28" Wide Large Pivoting Wall Rack	32 3/8" D X 62 3/4" H
	SR28-40-32	28" Wide Large Pivoting Wall Rack	32 3/8" D X 90 3/4" H
	SR28-46-32	28" Wide Large Pivoting Wall Rack	32 3/8" D X 101 1/4" H

DISPLAY MOUNTS

Proximity Series AV Storage Solutions

NEW

SLIDING MOUNTING PLATE CONCEAL EQUIPMENT BEHIND THE DISPLAY



The Proximity Series Mounting Plate features an unrivaled, patent-pending sliding design that pulls out from behind the display for effortless servicing and concealment of equipment

- Removable, Lever Lock™ plate allows post-installation accessibility without disturbing the display
- Patented UMS hold pattern simplifies mounting of devices
- Wall mountable for universal use with any display



NEED MORE STORAGE FOR LARGER, SOPHISTICATED AV SYSTEMS?

The Proximity Series In-Wall Boxes

- The industry's only in-wall boxes built for small device mounting flexibility with patented Lever Lock™ technology built-in
- Four levels of mounting space offer unmatched configurability to maximize space for storage of gear
- Boasting the industry's first AV storage solution for 24" stud bays, the in-wall boxes now include 3 sizes to fit the needs of the system: 22"x14", 14"x14", and 9"x14"
- Proximity box covers now available to restrict visibility and access to equipment



PRX-WB-9X14



PRX-WB-14X14

CERTIFICATIONS

- UL Listed
- GREENGUARD Certified
- Product Environmental Profile

Part #	Description	Dimensions	Covers
PRX-MP-9X12	Mounting plate attaches to any standard VESA mount	9" x 12" plate, 17" x 2-3/4" mounting bracket	
PRX-SMP-15X10	Sliding mounting plate attaches to VDM Series Multi-Display Wall and Ceiling Mounts or mounts directly to wall	15" x 10" plate	
PRX-WB-9X14	In-Wall box ideal for storage behind the display, includes 1 Lever Lock™ 4" plate	9-1/4" x 14-1/4" x 3-13/16"	PRX-WB-CVR-9X14
PRX-WB-14X14	In-Wall box ideal for storage behind the display, includes 2 Lever Lock™ 4" plates	14-1/4" x 14-1/4" x 3-13/16"	PRX-WB-CVR-14X14
PRX-WB-22X14	In-Wall box ideal for storage behind the display, includes 3 Lever Lock™ 4" plates	22-1/4" H x 14-1/4" W x 3-33/50" D	PRX-WB-CVR-22X14

NEW

DISPLAY MOUNTS

VDM Series Single Display Wall Mounts



UTB-HR-A2-14
shown with front and rear cover

DISPLAY MOUNTING SAFE, RELIABLE, EFFICIENT

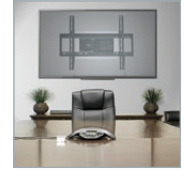

VDM Series Vision Display Mounts are designed to provide safe, reliable display mounting with the professional features that enable efficient installation.

- Proximity mounting plate included with most standard profile mounts to enable location of the AV system directly behind the display
- Post-install leveling mechanism enables quick micro-adjustment of horizontal plane of display
- Safety locking features keep the display securely mounted
- Certified to UL 2442 for safe, reliable installs
- Available in standard profile or low profile with kick stand for additional space between the mount and wall for ease of installation and servicing
- Motion, tilt and fixed models available
- Accommodate VESA patterns up to 800mm



STANDARD PROFILE
VDM-600-T

LOW PROFILE
VDM-600-T-LP

MOTION
VDM-400-M

	Part #	Type	Suggested Display Size*	VESA MAX*	Display Weight Capacity*	Mounting Plate Included
Low Profile	VDM-800-T-LP	Tilt	46" - 90"	800	150 lbs.	no
	VDM-600-T-LP	Tilt	40" - 70"	600	100 lbs.	no
	VDM-400-T-LP	Tilt	22" - 46"	400	80 lbs.	no
	VDM-800-F-LP	Fixed	46" - 90"	800	150 lbs.	no
	VDM-600-F-LP	Fixed	40" - 70"	600	100 lbs.	no
	VDM-400-F-LP	Fixed	22" - 46"	400	80 lbs.	no
Standard Profile	VDM-800-T	Tilt	46" - 90"	800	200 lbs.	yes
	VDM-600-T	Tilt	40" - 70"	600	180 lbs.	yes
	VDM-400-T	Tilt	22" - 46"	400	150 lbs.	yes
	VDM-200-T	Tilt	13" - 37"	200	80 lbs.	no
	VDM-800-F	Fixed	46" - 90"	800	200 lbs.	yes
	VDM-600-F	Fixed	40" - 70"	600	180 lbs.	yes
	VDM-400-F	Fixed	22" - 46"	400	150 lbs.	yes
	VDM-800-M	Motion	46" - 90"	800	150 lbs.	yes
	VDM-600-M	Motion	40" - 70"	600	100 lbs.	yes
	VDM-400-M	Motion	22" - 46"	400	50 lbs.	yes
VDM-200-M	Motion	13" - 37"	200	40 lbs.	no	

*Please consult A&E Specification for complete details

DISPLAY MOUNTS

VDM Series Multi-Display Wall and Ceiling Mounts



DESIGNED FOR FLEXIBLE APPLICATIONS AND EFFICIENT INSTALLATIONS



These mounts incorporate a modular design that accommodates multi-display wall, ceiling, menu board, and digital signage applications.

- The modular design allows the mount to be deployed in different configurations including on-wall, ceiling, or back-to-back for the same install experience no matter the application
- Same trusted mounting method found in DisplayStation & C5 Credenza Monitor Mount products
- Compatibility with Proximity Series Sliding Mounting Plate and Proximity Series In-Wall Boxes enables location of the AV system directly behind the display
- Certified to UL 2442 for safe, reliable installs
- Post-install leveling mechanism enables quick micro-adjustment of height, depth and horizontal plane of display
- Patent-pending bracket design allows up to 20° of tilt on the display
- Safety locking features keep the display securely mounted



WALL
VDM-2x1-WM



CEILING
VDM-2x1-CM



BACK-TO-BACK
VDM-3x1-B2B-CM

Part #	Description	# of Total Displays	Display Configuration
VDM-600-CM	VDM Series 1x1 ceiling mount	1	ceiling mount
VDM-600-B2B-CM	VDM Series 1x1 back-to-back ceiling mount	2	back-to-back ceiling mount
VDM-2X1-CM	VDM Series 2x1 ceiling mount	2	ceiling mount
VDM-2X1-B2B-CM	VDM Series 2x1 back-to-back ceiling mount	4	back-to-back ceiling mount
VDM-2X1-WM	VDM Series 2X1 wall mount	2	wall mount
VDM-3X1-CM	VDM Series 3x1 ceiling mount	3	ceiling mount
VDM-3X1-B2B-CM	VDM Series 3x1 back-to-back ceiling mount	6	back-to-back ceiling mount
VDM-3X1-WM	VDM Series 3X1 wall mount	3	wall mount

POLES AND ADAPTERS FOR CEILING APPLICATIONS

Part #	Description	Part #	Description	Part #	Description
VDM-F-12-BK	VDM Series 12" fixed extension pole	VDM-A-24-36-BK	VDM Series 24-36" adjustable extension pole	VDM-CA-8X8-HC-BK	VDM Series 8x8 high capacity ceiling adapter
VDM-F-24-BK	VDM Series 24" fixed extension pole	VDM-A-36-60-BK	VDM Series 36-60" adjustable extension pole	VDM-CA-2J-BK	VDM Series dual joist ceiling adapter
VDM-F-36-BK	VDM Series 36" fixed extension pole	VDM-A-48-72-BK	VDM Series 48-72" adjustable extension pole	VDM-CA-CATH-BK	VDM Series cathedral ceiling adapter
VDM-F-48-BK	VDM Series 48" fixed extension pole	VDM-A-72-96-BK	VDM Series 72-96" adjustable extension pole	VDM-CA-TRUSS-BK	VDM Series truss ceiling adapter
VDM-F-60-BK	VDM Series 60" fixed extension pole	VDM-A-96-120-BK	VDM Series 96-120" adjustable extension pole	VDM-CA-IBeam-BK	VDM Series i beam ceiling adapter
VDM-F-72-BK	VDM Series 72" fixed extension pole	VDM-A-120-144-BK	VDM Series 120-144" adjustable extension pole	VDM-CA-4X4-BK	VDM Series 4x4 plate ceiling adapter
VDM-A-12-18-BK	VDM Series 12-18" adjustable extension pole	VDM-OFC-BK	VDM Series extension open face coupler	VDM-CA-8X8-BK	VDM Series 8x8 plate ceiling adapter
VDM-A-18-24-BK	VDM Series 18-24" adjustable extension pole	VDM-CC-BK	VDM Series extension closed coupler	VDM-CA-COVER-BK	VDM series ceiling cover plate

NEW

DISPLAY CARTS

FlexView Series IFP Carts



2 MODELS



Electronic Lift



Fixed

2 BASE COLORS



White



Black

DISPLAY CARTS

FlexView Series IFP Carts

NEW

A THING OF ADJUSTABLE BEAUTY FOR EVERYONE AND EVERY SPACE



The FlexView Series IFP Cart line is the paragon for interactive flat panel mounting with a triumvirate of an unmatched systems approach, accessibility for all heights, and artful aesthetics that blend the technology into any space.

- Superior capacity mounting for IFPs or displays ranging from 60" -102", with a large, 1200x600 VESA pattern and a robust weight capacity of 300lbs
- Unmatched equipment storage with 2RU vertical mounting and removable, tool-free Lever Lock™ for small device mounting as well as power distribution built in
- Available in white and black bases with premium aesthetics set this solution apart from all others
 - 5 optional finishes in wood and textured, metal HPL colors for interesting design elements to complement the décor in any space
- Offering includes fixed or height adjustable, ADA compliant electronic lift models
 - Height adjustability from 40" to 60" to center of the display paired with the unimpeded, scalloped base ensures the e-lift design is compliant with ADA standard 803 for reachability, achieving up close display interaction at the desired ergonomic setting for any user
 - Finishes correspond with Pre-configured technical furniture solutions, providing cohesive designs for any learning or meeting space



COMPLEMENTARY PRODUCTS



FVS-CMTB-1200-BK:
Black Camera Mount



FVS-CMTB-1200-WH:
White Camera Mount

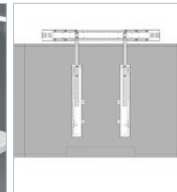

FVS-SBBU-1200:
Soundbar Bracket



FVS-Leverlers-4:
Leveling Feet

5 OPTIONAL FINISH OPTIONS*

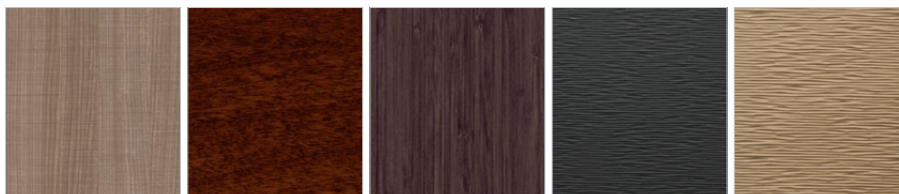

HPL: 5th Ave Elm

HPL: Scarlett Cherry

HPL: Asian Night

Chemetal: Black

Chemetal: Bronze



*Finishes are optional.

NEW

TECHNICAL FURNITURE

C5 Series Credenzas



NEW COLORS NOW AVAILABLE FOR PRE-CONFIGURED C5 SERIES CREDENZAS

HPL



Montana Walnut 5th Ave. Elm Asian Night Glamour Cherry White Ash Brite White Limber Maple Versaille Anigre

Thermolaminate

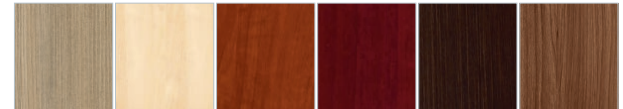

Ibis Native Maple Auburn Stream Napa Café Noir Sienna



- Contemporary style
- 1" wrap around the credenza
- Side panels and top completely flush
- Inset doors



- Simplified contemporary
- Overlay doors
- Top completely flush

*Please consult A&E Specification for complete details

MIDDLE ATLANTIC PRODUCTS

TECHNICAL FURNITURE

C5 Series Credenzas

NEW

RACK FOUNDATION WITH A FURNITURE FINISH

The C5 Series Credenza offering addresses the latest trends in commercial interior design. The credenza system built around the rack you trust is now available in several styles with a wide variety of furniture finish options.



- Attractive styles, finishes and options reflect current design trends
- Frames are in stock guaranteeing quick delivery while allowing the integrator to immediately start the installation
- Choose a pre-configured model or design to your specification at middleatlantic.com
- Built-in low noise, high static pressure blowers for efficient, quiet cooling
- Veneer, high-pressure laminate and thermolaminate finishing options
- Available in 1, 2 or 3-bay models with standard or extra depth
- Vent finishes in white, black, silver or off-white
- Door hardware, locks and plexi door options available
- Monitor mounts available
- Push-touch latch
- Styles correspond to T5 Series conference tables (pg. 14)

CERTIFICATIONS

- UL Listed
- GREENGUARD Certified
- Product Environmental Profile



sota

emporary style ideal for pairing

sh



klasik

- Traditional style with classic detail
- Overlay doors
- Veneer only
- Top overhang

NEW

TECHNICAL FURNITURE T5 Series Conference Tables



sota



klasik

- Rectangular Surface Shape
- Self edge
- HPL, Veneer

- Boat Surface Shape
- Ogee edge
- Veneer Only



FINISH OPTIONS



HPL: 5th Ave Elm HPL: Glamour Cherry HPL: Asian Night Veneer: Sandy Maple Veneer: Scarlett Cherry Veneer: Sepia Walnut



27

EXPLORE ALL MODELS
ON MIDDLEATLANTIC.COM

TECHNICAL FURNITURE

T5 Series Conference Tables

NEW

ULTIMATE SYSTEM RELIABILITY FOR AV TECHNOLOGY



Featuring attractive styles and finishes reflective of commercial interior design trends, the T5 Series offers discreet storage and care for AV gear within a beautiful furniture solution.

- Each T5 solution includes a table top, support pedestals and a separately shipped Tech Kit that allows integration to begin immediately. The Tech Kit is optimized for the designated table size and is comprised of the critical infrastructure that supports reliable AV systems:
 - Patent-pending swing-out pedestal rack can be located in the table pedestal of choice
 - Innovative flexibility for up to 3 RU of sideways rackmounting, small device mounting or a combination of the two
 - Includes three tool-free Lever Lock™ plates for mounting small devices
 - Wiremold® InteGreat Table Boxes in black or silver with 2 retracting HDMI cables and 2 AC outlets for power and connectivity at the surface. Table boxes and cable retractors are concealed by the table's pedestal
 - Vertical power distribution
 - Cable management strips and bridge lances
- Styles and finishes correspond with Pre-configured C5 Series Credenzas, providing a cohesive meeting space design
- Pedestal locks to secure equipment within

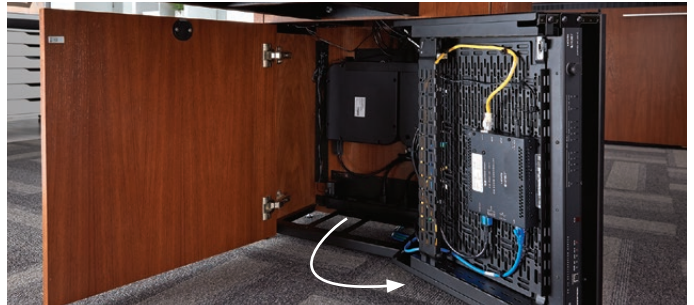

3 SIZES AVAILABLE

8'	SEATS UP TO 8 USERS	12'	SEATS UP TO 12 USERS	16'	SEATS UP TO 14 USERS
----	---------------------	-----	----------------------	-----	----------------------

OPTIONS & ACCESSORIES

	Part #	Description
TECH KITS	T5-TECHKIT8S	T5 techkit rack, connectivity & power system, 2 silver Integreat boxes, for 8' length table systems
	T5-TECHKIT12S	T5 techkit rack, connectivity & power system, 3 silver Integreat boxes, for 12' length table systems
	T5-TECHKIT16S	T5 techkit rack, connectivity & power system, 3 silver Integreat boxes, for 16' length table systems
	T5-TECHKIT8B	T5 techkit rack, connectivity & power system, 2 black Integreat boxes, for 8' length table systems
	T5-TECHKIT12B	T5 techkit rack, connectivity & power system, 3 black Integreat boxes, for 12' length table systems
	T5-TECHKIT16B	T5 techkit rack, connectivity & power system, 3 black Integreat boxes, for 16' length table systems
OPTIONS	T5-RACK-KIT	T5 conference table 3 space swing out, Lever Lock™ and cable management kit
	T5-LLOCKBKT-KIT	T5 3 piece Lever Lock™ with 2 rack adaptors, fits T5 swing out 3 RU rack
	T5-DCFANKIT-1	DC fankit 2 80mm fans, 50cfm, thermostatically controlled



NEW

TECHNICAL FURNITURE

L2 Series Lecterns



BUDGET-FRIENDLY ALL-IN-ONE LECTERN



The L2 Series is the only budget-friendly lectern solution that delivers support and security for AV systems, complete with a patent-pending rack, power, thermal and cable management, and connectivity

- Each L2 Lectern includes critical infrastructure for an all-in-one, budget-friendly solution
- The 12RU removable rack boasts a tool-less experience with easy access to rear connections or removal for simple servicing, yet locks in place for transportation and usage
- The accessible rack design allows for a clean, seamless audience facing panel
- Sleek Sota style with a durable melamine finish for an attractive mobile solution to house AV equipment
- Simplified selection of easy-to-order, pre-configured models available in 3 popular colors
- Flip up shelf for extra surface space on certain models
- Slide out shelf houses a keyboard without taking up valuable workspace
- Locking, heavy duty 4" casters for a safe, mobile solution
- Ships from stock

COLORS



knotted maple



grained dark cherry

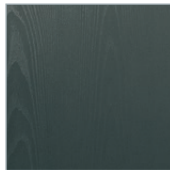

grained ebony ash

ACCESSORIES

INCLUDED



patent-pending removable rack



surface power unit



8 outlet surge protected power strip



thermostatically controlled fan



6' C26[®] HDMI[®] cable



cable management

OPTIONAL



flip up shelf

MIDDLE ATLANTIC PRODUCTS

TECHNICAL FURNITURE

L5 Series Lecterns

NEW

STYLISH, EASILY INTEGRATED LECTERN SYSTEM

The L5 Series accentuates the latest trends in room aesthetics with stylish designs and finishing options, but is built around the rack you trust.



SOTA STYLE

- Available pre-configured or tailored to your specification through the Middle Atlantic online design experience
- Built around the rack you trust and designed to support small device mounting, thermal and cable management, and power distribution for ultimate system reliability
- Attractive styles, finishes and color options reflect current design trends
 - Now available pre-configured solutions in 6 of the most popular colors and finishes
- New optional storage to accommodate the most popular document cameras and/or small devices
- Durable, no pinch flip up shelf is available to add extra surface space
- Frames are in stock guaranteeing quick delivery and allowing the integrator to immediately start the installation



IN VANNER, HPL, TLAM FINISHES



STYLES



klasik



sota

TOPS



turret



flat

SIZES



23"



33"



43"

ACCESSORIES



drawers



flip up shelf

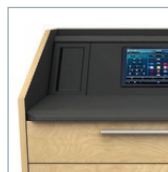

Presenter's Panel touch screen cutout

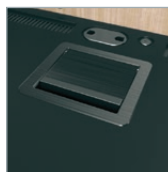

flat top table box cutout



gooseneck light



monitor mount



tablet mount



shockmount microphone holder



4" clock timer



custom logos



Lever Lock™ accessories

TECHNICAL FURNITURE L7 Series Lecterns



THE MOST ELEGANT SOLUTION

IN HEIGHT ADJUSTABILITY AND ADA

Pioneering the path to designer, height adjustable technical furniture—the L7 Series Lectern, a pinnacle of the workspace desired, height required and aesthetically inspired.



BUILT FOR INTEGRATORS

- Welded steel frame with configurable storage ships assembled allowing the integrator to immediately start the installation in the shop or on-site
- Additional small device storage equipped with removable, tool-free Lever Lock™ small device mounting hidden just below the worksurface
- Integrated power, cable and thermal management for ultimate system reliability
- Popular AVIP connectivity plates for higher education application

DESIGNED FOR EDUCATORS

- Ergonomically engineered to adjust to varying height requirements of its users via electronic lift with 10" of vertical adjustment
- Design complies with ADA, providing ample room for wheelchair clearance and minimum reach requirements
- Generous 61" x 31" surface provides adequate workspace to accommodate the personal devices and effects of transient professors
- Wireless charging pad to charge Qi cellular devices during class
- Additional BYOD connectivity with plenty of USB and AC outlets
- Storage for markers, microphones and wires



TECHNICAL FURNITURE

L7 Series Lecterns

NEW



1 ADA COMPLIANT SIZE



welded steel frame with configurable storage ships assembled allowing the integrator start the installation immediately

2 SURFACE SOLUTIONS FOR CONTROL PANELS (CRESTRON 1060 & 760) OR STORAGE



7" or 10" touch screen cutout—fitting the Crestron 760 & 1060 touch screen
*If turret is not desired, extra storage will be provided



4 STORAGE SOLUTIONS

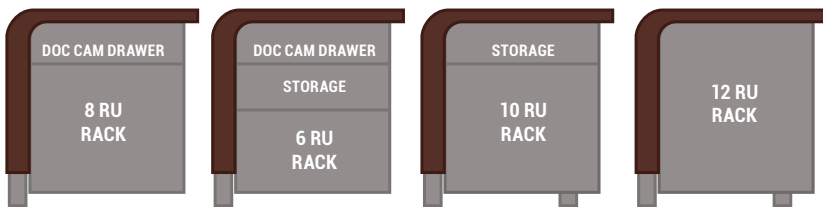

3 ATTRACTIVE HPL FINISH OPTIONS



glamour cherry

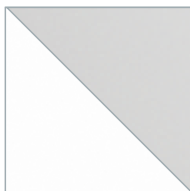

brite white

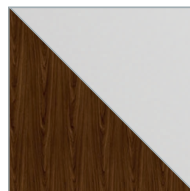

montana walnut



TECHNICAL FURNITURE Finishes

Middle Atlantic Products offers furniture in a variety of materials and colors to meet the demands for design flexibility, durability & price.



MELAMINE

- Value-priced material with maximum durability
- The fastest lead time with mobile furniture racks & complete, all-in-one lecterns that ship from stock
- Available for L2 Series Lecterns, MFR Series and RFR Series

THERMOLAMINATE

- Fast lead time with wood kits typically shipping in 3 weeks
- Available for Moderno, Sota and Klasik style products
- Available for Hub, C5 Series Credenzas, L5 Series Lecterns and TechPed



HIGH PRESSURE LAMINATE

- Maximum durability
- Lead time for HPL wood kits is typically 6 weeks
- Available for Moderno and Sota style products
- Available for Hub, C5 Series Credenzas, T5 Series Conference Tables, L5 Series Lecterns, L7 Series Lecterns, and FlexView Series IFP Carts.
- Textured, metallic finishes now available

VENEER

- The premium material choice with authentic wood surface
- Lead time for Veneer wood kits is typically 12 weeks
- Available for Moderno, Sota and Klasik style products
- Available for C5 Series Credenzas, L5 Series Lecterns and T5 Series conference tables

60+

Colors in the 4 finishing options available for configured solutions* to match any color scheme with the additional option for custom color matching. For a full list of available colors, visit middleatlantic.com/finishes.

PRE-CONFIGURED FURNITURE

Finishes

NEW

Pre-configured offering in lecterns, credenzas, conference tables, and interactive flat panel carts for a simple start to a complete solutions.

PRE-CONFIGURED L2 SERIES LECTERNS



MELAMINE OPTIONS



PRE-CONFIGURED L5 SERIES LECTERNS AND C5 SERIES CREDENZAS



HPL OPTIONS



THERMOLAMINATE OPTIONS



HPL OPTIONS



THERMOLAMINATE OPTIONS

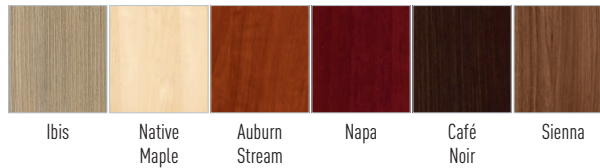

PRE-CONFIGURED L7 SERIES LECTERNS



HPL OPTIONS

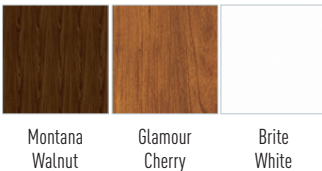

PRE-CONFIGURED T5 SERIES CONFERENCE TABLES



HPL OPTIONS



VENEER OPTIONS

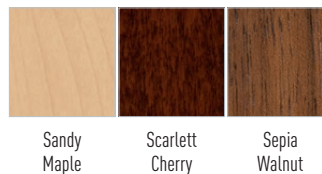

PRE-CONFIGURED FLEXVIEW SERIES IFP CARTS



HPL OPTIONS



CHEMETAL OPTIONS



*finishes subject to change based on manufacturer's availability

NEW

POWER

Select Series PDU with RackLink™



VERSATILE, VALUE-ORIENTED INTELLIGENT POWER



Select Series PDU with RackLink™ simplifies installation and reduces the cost of service by providing intelligent power optimized for AV systems.

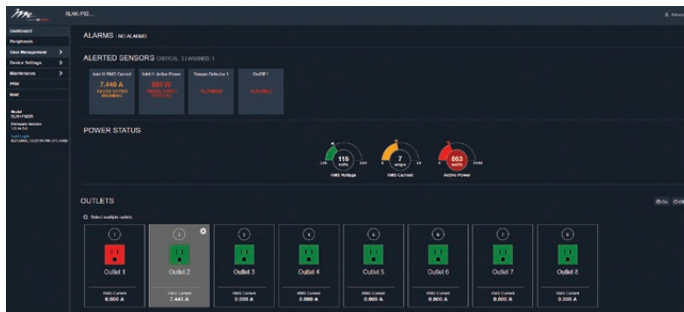
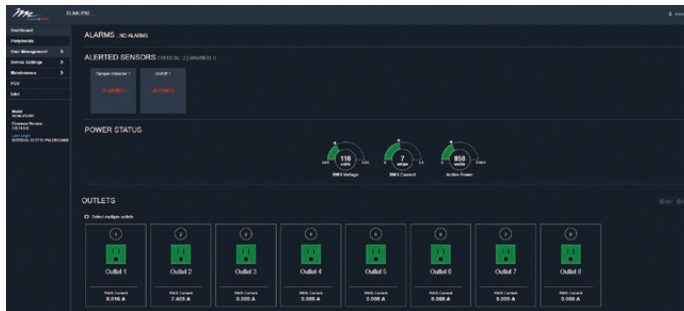

RACKLINK™ USER INTERFACE

- Individual IP outlet control of up to 8 outlets
- NEW vertical PDUs as well as compact, half rack, and horizontal form factors
- Multiple IP autoping and recovery ensuring optimal system functionality
- Control start-up and/or shut-down with remote sequencing
- Easy set-up and control through RackLink user interface
- MOV surge and spike protection
- Fast and easy commissioning
- Automatic actions improve system reliability
- Automatic notification of connection status
- Seamlessly interfaces with 3rd party AV control systems and cloud platforms for scheduling, control, reporting and customized actions



RLNK-1015V



RLNK-1615V

Part #	Description	Max Load	Form Factor	# of Outlets	
				Total	Controlled
RLNK-215	compact IP controlled power with RackLink™	15A	compact	2	2
RLNK-415R	rackmount IP controlled power with RackLink™	15A	half rack	4	4
RLNK-915R	rackmount IP controlled power with RackLink™	15A	rackmount	9	8
RLNK-1015V	low profile vertical IP controlled power with RackLink™	15A	vertical power strip	10	4
RLNK-1615V	low profile vertical IP controlled power with RackLink™	15A	vertical power strip	16	8

POWER Controlled Wall Plate

NEW

SIMPLE, LOCAL, SECURE CONTROL TO POWER DEVICES

Ideal for powered loudspeakers, the Controlled Wall Plate delivers exceptional value without the complexity and expense of breaker panels or multiple high/low voltage boxes.

- Dry contact closure input with no external voltage required for control
- Not susceptible to voltage drops on control wire
- Rear integrated contact closure to alleviate the need to run the control wire to the front of the wall plate
- Neutrik PowerCON® receptacle that locks the power cable to the device and wall to mitigate the potential of accidental unplugging
- Compact, Decorator-style insert complete with metal wall plate to fit any standard single gang box
- LED indicator for power
- Available with 20A PowerCON® receptacle



Part #	Description
CWP-115	12A rated remotely switched NEMA 5-15R receptacle
CWP-120-PCON	16A rated remotely switched PowerCON receptacle

NEW

POWER

High Power DC Distribution

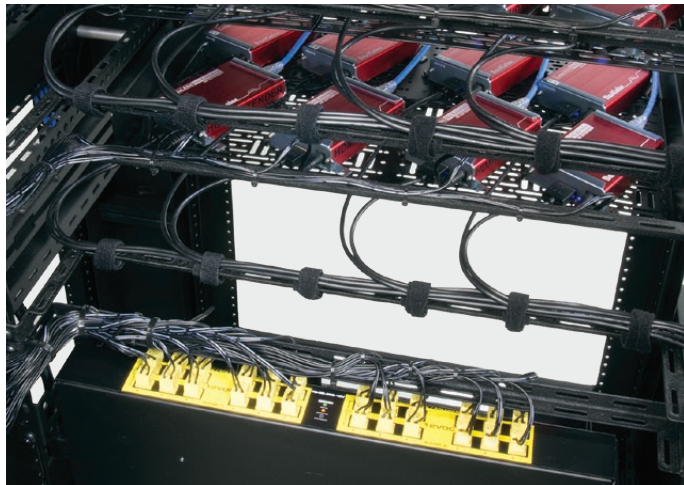

HIGHEST AVAILABLE POWER

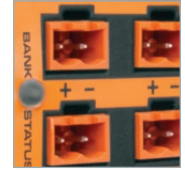

Design on reliability with the universal DC power solution equipped with the highest available power in the market—complete with superior current capacity and an industry-leading quantity of outputs!

- Industry-leading number of outputs with power distributed to as many as 24 devices
- Maximum current capacity, up to 300W of power
 - 5V, 40A Max (200W)
 - 12V, 25A Max (300W)
 - 24V, 12.5A Max (300W)
 - 12V and 24V, 12.5A and 6.25A respectively (300W)
- Reliable multi-level protection on both AC input and DC outputs to ensure maximum uptime
 - MOV surge and overload protection on the AC input
 - Individual redundancy built in with auto-resetting PTC overload protection on each individual output
- Greater mounting flexibility with multi-mount design that fits in 1 rackspace or can mount at the back or side of the rack simply by rotating mounting brackets
- LED indicator lights alerting maximum capacity on each voltage bank
- Leads trimmed to suitable length leaves less cable to manage, enhancing aesthetics and increasing airflow
- Ultra-quiet, thermostatic temperature controlled fan with automatic speed adjustment

CONNECT UP TO 24 DEVICES!



Part #	Description	Outputs	Watt Max Output
PD-DC-200-5V	maximum power, 200W DC power distribution	5V	200
PD-DC-300-12V	maximum power, 300W DC power distribution with 12V outputs	12V	300
PD-DC-300-24V	maximum power, 300W DC power distribution with 24V outputs	24V	300
PD-DC-300-12-24V	maximum power, 300W DC power distribution with split-bank	12V and 24V	300

POWER

Multi-Voltage DC Power Distribution

NEW

MAXIMUM VOLTAGE FLEXIBILITY

Clean up the rack by replacing messy, space consuming wall warts and power strips with a DC power solution designed for maximum voltage flexibility.



- Multiple voltage outputs (5V, 12V, 18V*, & 24V*) supported in a single box form factor
- Reliable multi-level protection on both AC input and DC outputs to ensure maximum uptime
 - MOV surge and overload protection on the AC input
 - Individual redundancy built in with auto-resetting PTC overload protection on each individual output

*5V USB ports provided to conveniently power compatible products

PD-DC-45



PD-DC-125R

- 45W compact and 125W multi-mount systems support a wide range of applications from small systems in tight spaces to enclosures in large distributed systems
- LED indicator lights showing activity on each output and indicating capacity on each voltage bank



Part #	Description	Outputs	Max Output
PD-DC-45	compact universal DC power distribution	5V and 12V	45W
PD-DC-125R	multi-mount 1 RU universal DC power distribution	5V, 12V, 18V and 24V	125W

NEW

POWER

Premium Online Series UPS Backup Systems



PERFECT, ISOLATED, UNINTERRUPTED BACKUP

When failure is not an option, the Premium Online Series UPS Backup Power Systems provide the cleanest power for mission critical, sensitive, and high-end systems.

- Permanent connection to the battery for zero transfer time eliminating system disruptions and guaranteeing maximum uptime
- Complete isolation and conditioning of output power with double conversion topology providing the cleanest power possible
- Reduced ambient noise with quiet variable speed fans
- Longest run time available in this form factor with the capability to add up to 10 expansion battery packs
- Front accessible, hot-swappable batteries to eliminate downtime related to UPS power maintenance
- Pure sine wave output waveform automatically corrects over-voltage and under-voltage conditions
- Non-critical load shedding
- Monitoring and reporting for real time battery life notifications
- Removable LCD display & power switch for remote accessible functionality

part of the family of UPS solutions



	Part #	Description	Outlet Controlled	Dimensions	Termination	Rackspaces	Replacement Battery Pack
15 Amp	UPS-OL1500R	1500VA / 1350W	bank control	19.00" W x 3.50" H x 15.50"D	10' cord w/NEMA 5-15P Plug	2 space	UPS-OLRBP-3
20 Amp	UPS-OL2200R	2200VA / 1800W	bank control	19.00" W x 3.50" H x 22.25"D	10' cord w/NEMA 5-20P	2 space	UPS-OLRBP-1
30 Amp	UPS-OL3000R	3000VA / 2700W	bank control	19.00" W x 3.50" H x 22.25"D	10' cord w/NEMA L5-30P	2 space	UPS-OLRBP-1
	UPS-OLEBPR-1	Expansion Battery Pack 2200/3000VA	-	19.00" W x 3.50" H x 22.25"D	-	2 space	UPS-OLRBP-2 (2 each)
	UPS-OLEBPR-2	Expansion Battery Pack 1500VA	-	19.00" W x 3.50" H x 15.50"D	-	2 space	UPS-OLRBP-3 (left) UPS-OLRBP-4 (right)

LOW LOSS POWER INSERTION WITH 4K60 AV



The High Speed HDMI Cable with Built-In Power Inserter 4K60 is the ideal solution for supporting HDMI bus-powered devices such as extenders, active cables, AOC cables or signal-sensing switches. This cable eliminates the need for separate voltage inserters or adapters, which increases reliability



- Supports up to a 4K resolution at 60Hz
- Low loss power insertion
- Attached Micro USB female power inserter
- Micro USB male to USB-A male cable
- Attached power inserter isolates the power from the source device and provides dedicated power to support HDMI switching, splitting, and extension accessories
- Allows for the necessary and proper voltages for the hardware "handshake", HDCP key authentication and exchange, EDID information exchange and hot plug connection detect

Part #	Description	Length	Resolution
56790	High Speed HDMI Cable with Built-In Power Inserter	6ft	4k at 60Hz
56791	High Speed HDMI Cable with Built-In Power Inserter	10ft	4k at 60Hz
56792	High Speed HDMI Cable with Built-In Power Inserter	15ft	4k at 60Hz

CODE COMPLIANT HDMI® THAT MAINTAINS SIGNAL



The plenum-rated HDMI® CL2P cables with gripping connectors are designed to be installed in AV applications requiring HDMI® features while meeting strict building code requirements.



- CL2P plenum rated jacket for in-wall installation in plenum, riser, and general spaces
- Gripping connector for 3X greater retention than standard HDMI® connector
- High speed cables support up to 4K video resolution at 50/60 Hz
- Standard speed cables support up to 1080i video resolution
- Gold plated connectors
- TAA compliant

Part #	Description	Length	Resolution	Jacket Rating
42528	CL2P High Speed HDMI® cable with gripping connectors	15 ft.	4k	CL2P Plenum Rated
42529	CL2P High Speed HDMI® cable with gripping connectors	25 ft.	4k	CL2P Plenum Rated
42530	CL2P Standard Speed HDMI® cable with gripping connectors	35 ft.	1080i	CL2P Plenum Rated
42531	CL2P Standard Speed HDMI® cable with gripping connectors	40 ft.	1080i	CL2P Plenum Rated
42532	CL2P Standard Speed HDMI® cable with gripping connectors	50 ft.	1080i	CL2P Plenum Rated

NEW

C2G® CONNECTIVITY

HDMI® Extension & HDBaseT™ 4K HDMI® + HDMI® Extension



UNSURPASSED PULL STRENGTH SPECS



Active Optical HDMI® Cables can be used in plenum applications where standard Active HDMI cables can't go. The cable diameter is smaller than copper and more flexible which makes it easier to install in tight spaces. Constructed from fiber strands, this cable reduces the risk of EMI/RFI so performance is stable even when high resolution & consistent display are critical. CL3-rated jacket for in-wall installations

Part #	Description	Length	Jacket Rating
41378	High Speed HDMI® Active Optical Cable 23 ft.	4K	CMP (Plenum)
41370	High Speed HDMI® Active Optical Cable 33 ft.	Up to 328ft	Wall Plate/Dongle Kit
41371	High Speed HDMI® Active Optical Cable 50 ft.	Up to 328ft	Dongle/Wall Plate Kit
41372	High Speed HDMI® Active Optical Cable 75 ft.	Up to 328ft	Dongle/Dongle Kit
41373	High Speed HDMI® Active Optical Cable 100 ft.	Up to 328ft	Box/Box Kit
41374	High Speed HDMI® Active Optical Cable 131 ft.	Up to 328ft	Dongle/Dongle Kit
41375	High Speed HDMI® Active Optical Cable 164 ft.	Up to 328ft	Box/Box Kit

- 110 lb. pull strength specification—far surpassing the 20 lb. pull rating of other cables on the market
- 6mm bend radius
- Supports up to a 4k resolution
- No external power required
- Plenum rated jacket
- Now, in new lengths—23ft-164ft!



HDMI® EXTENSION ON A BUDGET



The HDMI Over Cat5/6 Extender is ideal for extending digital video and audio up to 164ft over new or even existing Cat5 or Cat6 cable infrastructure for cost-effective reliability, while maintaining high performance quality.

- Requires a single Cat5 or Cat6 cable
- Supports 1080p and 3D
- HDMI transfer rate of 6.75Gbps
- International power supply also included

Part #	Description	Length	Resolution
60160	HDMI Over Cats/6 Extender	Up to 164ft	1080p

C2G® CONNECTIVITY USB 2.0 Extender

NEW

ONE CABLE FOR AV AND DATA

This HDBaseT™ extender is an ideal solution to deliver 4K HDMI® and USB signals over a single cable from a computer or media player to an interactive whiteboard, interactive projector, touchscreen or to connect a conference camera system.



- Utilizes HDBaseT 2.0 Chipset VS2310
- HDBaseT Certified
- Enables extension up to 328 feet (100 meters)
- Supports HDMI 4K 3840 x 2160 resolution at 60Hz with 4:2:0 color space
- Supports USB 2.0 signals and functionality (4 USB ports available at the receiver end)
- Extends IR signal and serial control communication and features
- Supports EDID pass-through and HDCP 2.2

Part #	Description	Signal Type	Distance	Resolution	Form Factor	Device Type	Power Supply Requirement
29510	HDBaseT HDMI + USB Extender	HDMI & USB	328ft	4K 3840x2160	Box/Box	Kit	1*

*Requires power at the transmitter end of the solution

NEW

C2G® CONNECTIVITY DisplayPort™, HDMI®, and VGA to HDMI Adapter Converter Switch



CONNECTIVITY FLEXIBILITY WITH INTUITIVE OPERATION



Perfect for collaboration spaces including conference rooms and huddle spaces, this multi input converter switch offers four audio/video inputs which allow laptops, tablets, or other source devices to connect to one HDMI display. While manual switching is available when more control is desired, the auto switching feature simplifies the user experience by eliminating the need to interact with the device other than plugging in a laptop or tablet.

- Ideal for collaboration space applications
 - Switch between DisplayPort, 2 HDMI, and VGA audio video inputs
 - Convert a DisplayPort or VGA video and embed 3.5mm stereo audio signals to HDMI audio/video output
 - Supports automatic, priority, manual, and serial control switch options
-
- 4K support for HDMI and DisplayPort
 - Maximum VGA resolution: 1080p 60Hz
 - Maximum DisplayPort resolution: 3840x2160 at 30Hz
 - Maximum HDMI resolution: 3840x2160 at 30Hz
 - TAA Compliant

Part #	Description	Resolution	Form Factor
40848	DisplayPort™, HDMI® and VGA to HDMI Adapter Converter Switch	Up to 3840x2160 at 30Hz	Box

USB EXTENSION ON A BUDGET

Extend USB 2.0 signals for a single USB device up to 150 feet over a Cat5 or Cat6 cable. The 1-Port and 4-Port USB 2.0 Over Cat5/Cat6 Extenders are perfect for conference rooms and huddle spaces in need of innovatively simple, yet powerful solutions for extending USB signals beyond their native 16.4 foot length limitation.



- Supports High-Speed USB devices up to 480Mbps
- Extends a USB connection up to 150ft
- Suspend/resume detection
- Hot pluggable
- Plug and play, with no software or drivers required

Part #	Description	Length	Signal Type	Form Factor
54284	1-Port USB 2.0 Over Cat5/6 Extender	Up to 150ft	USB 2.0	
54285	4-Port USB 2.0 Over Cat5/6 Extender	Up to 328ft	USB 2.0	Box/ Box Kit

USB SPEED FOR EVERY NEED

Extend a SuperSpeed USB 3.0 signal 5m or connect two extenders to reach lengths up to 10m from a desktop, laptop, or remote terminal to a PTZ camera, interactive display, hard drive, or other peripheral device with this active USB 3.0 extension cable.



- Extend all functions of USB 3.0 up to 5m (16.4 ft.) or connect up to 2 extenders to reach lengths up to 10m (32.8ft)
- Data transfer rates up to 5Gbps for maximum speed in data delivery
- Backwards compatible with USB 2.0 and USB 1.1 devices
- Bus powered to eliminate the need for external power adapters
- Plug and Play—no driver required

Part #	Description	Length	Signal Type	Form Factor
39939	5m USB 3.0 Active Extension Cable	5m (16.4 ft.)	USB 3.0	Extension Cable

NEW

WIREMOLD® Wiremold Box with HDMI® + USB and Outdoor Power



TRANSFORMING MEETING ROOMS INTO WELL-CONNECTED SPACES



- Wiremold boxes with HDMI® + USB now available
- Elegant solution for extending power, communication and AV to the meeting presenter's point-of-use
- Boxes can be integrated with Wiremold Cable Retractors to keep cables safe and organized
- Attractive design with brushed, anodized cover in either black or aluminium finishes, with beveled edges and a "soft-touch" handle



GROUND BREAKING OUTDOOR POWER IN-GROUND AC DISTRIBUTION BOX



- First UL-Listed while in use in-ground box
- Tough enough to withstand a 5,000 lb load
- 20-amp, 30-amp and communications/AV options
- NEMA 6P wiring enclosure rated for wet locations
- Patented "air pocket" design keeps connections safe from water snow and ice in all seasons
- Mounts flush with any outdoor ground surface



SATISFY THE POWER HUNGRY OUTDOOR CHARGING STATION



Legrand Outdoor Charging Stations provide an ideal solution for employees, students, and guests to charge their mobile devices in outdoor spaces.

- 2- or 3-gangs of capacity for power and/or low voltage devices
- NEMA 3R rated for outdoor locations
- Choose from 3 versions: power pedestal, accent light or full area light
- Available in black, bronze, silver or custom finishes
- Visit www.legrand.us/outdoor for more information.

COMPLETE RACK ILLUMINATION FLEXIBILITY

The Rackmount LED Work Light is an integrator-focused rack lighting option offering unparalleled visibility during installation and servicing. Designed with flexible mounting and positioning capabilities, ensures premium illumination where the integrator needs it



rackmount LED work light installed in the BGR rack

- Complete flexibility to illuminate anywhere in the rack
 - The only rack light with both vertical and horizontal mounting capabilities to light anywhere it's needed or space is available
 - Adjustable-angle light bar can be positioned so that its bright white LEDs will maximize full rack height illumination
- Two models provide the freedom to choose the level of lighting needed for the size of the rack or installation: Single light or Dual light with interconnect cable.
- Ships with multiple power connections for expanded international application
- Low-profile, unobtrusive design won't impose on the installation and serviceability of the enclosure



dark



illuminated

rackmount LED work light installed in the C5 Series credenza

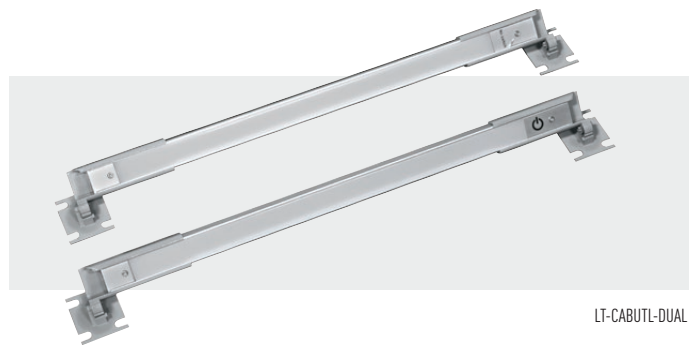

LT-CABUTL-DUAL

Part #	Description
LT-CABUTL-SINGLE	single rackmount LED work light, includes light bar with white leds, international power supply, cabinet attachment brackets
LT-CABUTL-DUAL	dual rackmount LED work light, includes light bars with white leds, international power supply, interconnect cable, cabinet attachment brackets

NEW

ACCESSORIES

Single Space RSH Series Custom Rackshelf

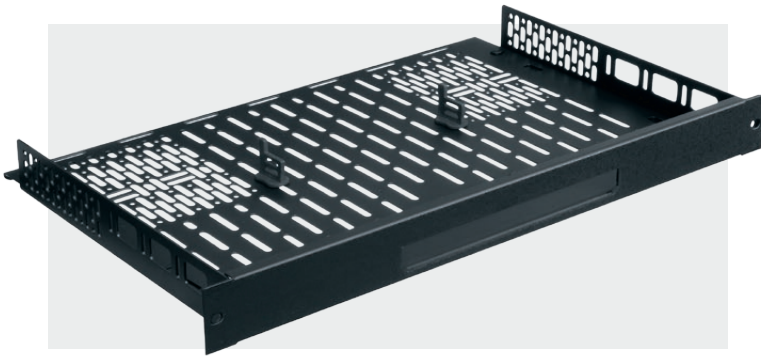

11.5" depth shelf shown

ADVANCED IN DESIGN

RSH Series Custom Rackshelves in single-rack-space size feature an advanced design unlike any other custom rackmount product.

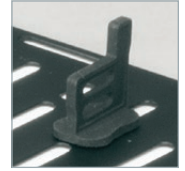

- The industry's shortest custom rackmount, occupying only a single rackspace
- Unique 'face-after' design allows for easy installation and switch-out of components
- Tool-free shelf assembly in seconds
- Choice of 11.5" or 8" depth shelf
- Add additional small devices and manage cables effectively using the patented universal mounting pattern
- Twist and lock rear stop brackets enable quick and fine adjustment of component positioning



Any RSH face can be cut to accommodate multiple components. 8" depth 1 RU model shown



SEARCH OUR 11,000+ COMPONENT MEASURED UNIT DATABASE AT MIDDLEATLANTIC.COM



E-TOOLS

The Web-Based Design Tool

NEW

middleatlantic.com BROWSE. SHOP. DESIGN

The design experience at middleatlantic.com will help you select the right products for your application, design the system to your specification, quote projects and place your order.

Sign up today and let us connect you to your account to unlock all these features. Here's what else you can expect from our award-winning web experience:

- Extensive database of over 43,000 components
- Find all compatible parts for the design quickly and easily with the NEW Universal Search, available when you select "Explore on Your Own"
- Add commonly-used third party components to My Library for quick access to add to any design

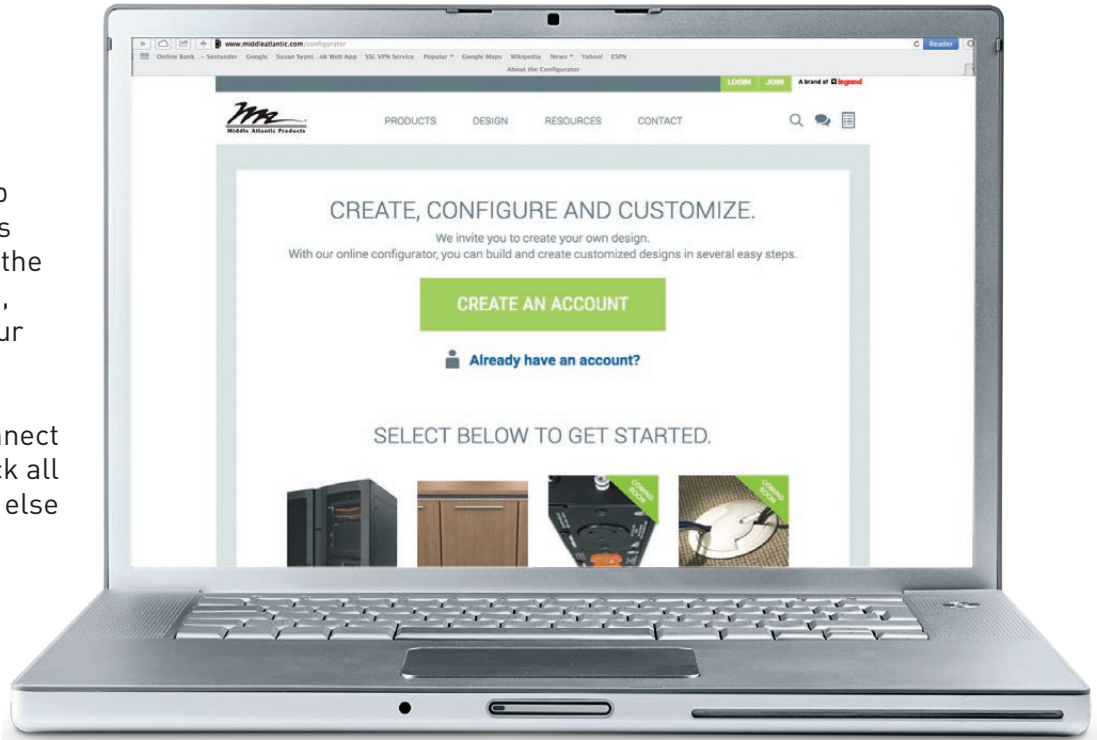

SEE IT
IN ACTION



- Create your own products to add to the design or your personalized My Library database
- Add rackmount, RSH Custom Rackshelf and shelf mount products to your design
- Create a personalized configured solution with a priced materials list
- Export CAD and other design documents
- Ability to revise quoted projects with one single click
- Built-in intelligence only recommends products & components that fit the chosen host enclosure
- Includes 48 rack series including wall mount and slide-out racks as well technical furniture solutions
- Available 24/7 on middleatlantic.com

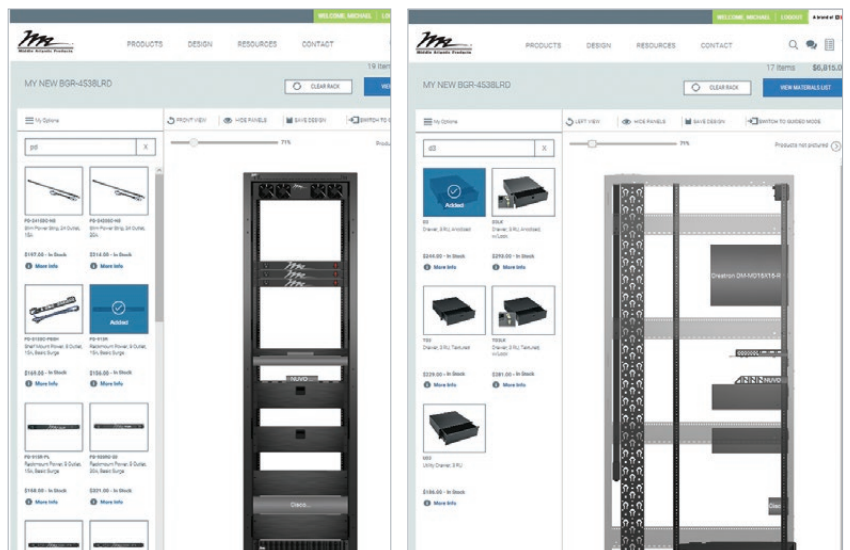



CORPORATE HEADQUARTERS
300 Fairfield Road, Fairfield, NJ 07004, U.S.A.
Voice: 800-266-7225 • Fax: 800-392-3955
International Voice: +1 973 839-1011
International Fax: +1 973 831-4982
middleatlantic.com

CANADA
113 Iber Road, Ottawa, Ontario K2S 1E7
Voice: 888-766-9770 • Fax: 888-599-5009
middleatlantic.ca

FACTORY DISTRIBUTION
USA: New Jersey • California • Illinois
Canada: Ontario
The Netherlands: Eindhoven



Middle Atlantic Products

Distributor: Phone: 407-857-8770
Fax: 407-857-8771
Email: sales@techni-lux.com
www.techni-lux.com



A brand of **legrand**